

# Flexbuild Annual Report 2

## TECHNICAL REPORT WITH RESULTS ANALYSIS

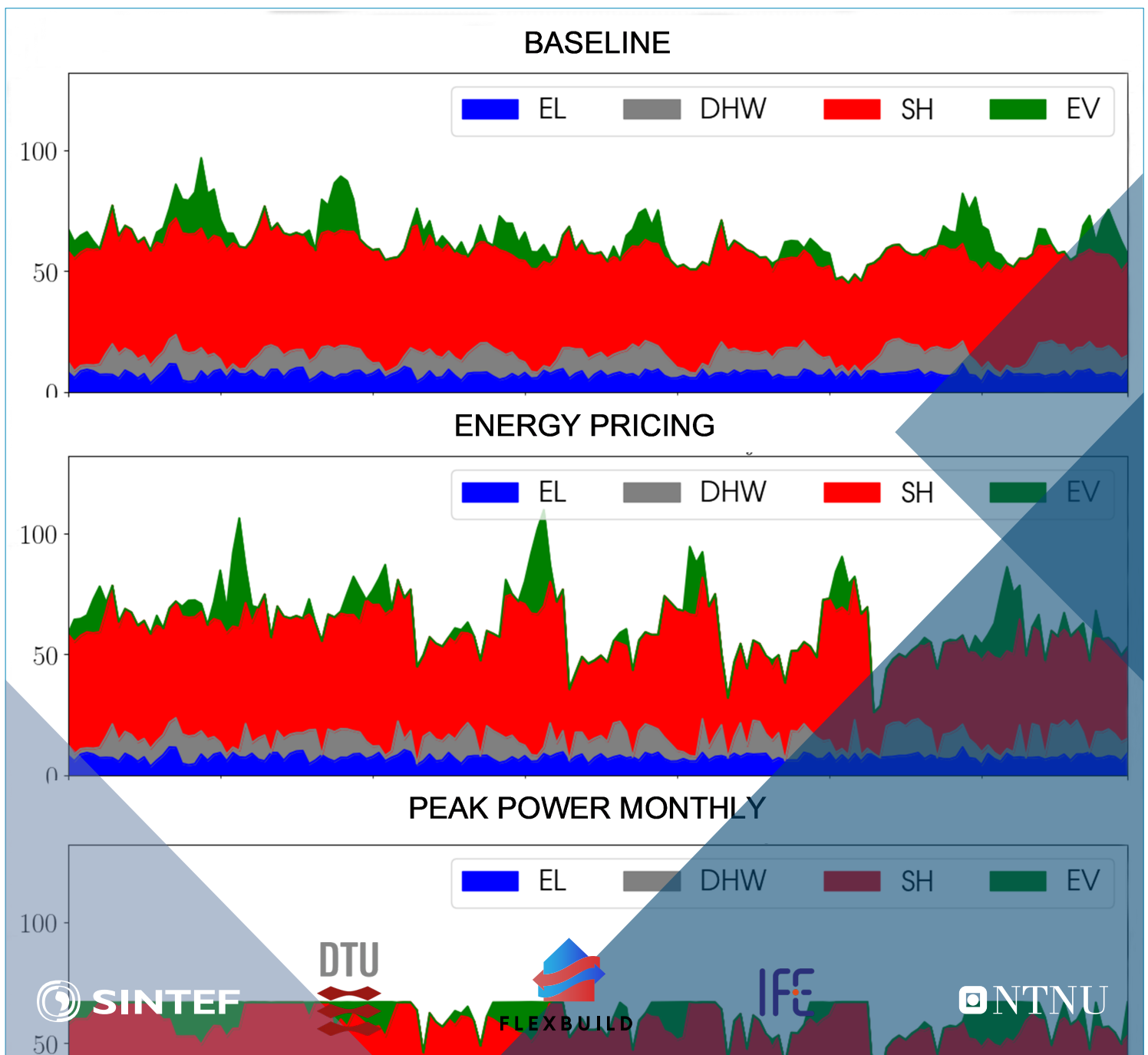

SINTEF Research

Igor Sartori, Karen Lindberg, Marius Bagle, Nina Holck Sandberg, Synne Lien, Mari Haugen,  
Pernille Seljom, Eva Rosenberg, Lisa Kvalbein, Raquel Pedrero Alonso,  
Mohammadreza Ahang, Pedro Crespo del Granado, Asgeir Tomasgard, Jaume Palmer,  
Jan Kloppenborg and Henrik Madsen

## **Flexbuild Annual Report 2**

Technical report with results analysis

SINTEF Academic Press

SINTEF Research 87

Igor Sartori, Karen Lindberg, Marius Bagle, Nina Holck Sandberg,  
Synne Lien, Mari Haugen (SINTEF)  
Pernille Seljom, Eva Rosenberg, Lisa Kvalbein (IFE)  
Raquel Pedrero Alonso, Mohammadreza Ahang, Pedro Crespo del Granado,  
Asgeir Tomasgard (NTNU)  
Jaume Palmer, Jan Kloppenborg, Henrik Madsen (DTU)

**Flexbuild Annual Report 2**  
**Technical report with results analysis**

Keywords: End-use flexibility, energy system modelling, building stock  
modelling, buildings energy system

ISSN 1894-1583  
ISBN 978-82-536-1738-1 (pdf)

Project no: 102020534



© 2022 The Authors. Published by SINTEF Academic Press.

This is an open access publication under the CC BY license

<https://creativecommons.org/licenses/by/4.0/>

## Preface

This report is a deliverable of the Flexbuild project, which is a knowledge-building project for industry (Kompetansebyggende prosjekt for næringslivet – KPN, in Norwegian) co-financed by the Research Council of Norway under the programme EnergiX, with grant agreement no. 294920/E20 for the period 2019–2024. The industrial partners in the project are: Statsbygg, Omsorgsbygg (Oslobygg), Boligbyggelaget TOBB, Norsk Fjernvarme, Hafslund nett (Elvia) and Statnett; the public actors are: Norges vassdrags- og energidirektorat (NVE) and Enova; the research partners are: Institutt for Energiteknikk (IFE), Norges teknisk-naturvitenskapelige universitet (NTNU) and Danske Tekniske Universitet (DTU), together with SINTEF that is the project leader.

Project webpage: <https://www.sintef.no/projectweb/flexbuild/>

Oslo, 1.3.2022

Trond Simonsen  
Research Director  
SINTEF Community

Igor Sartori  
Project Leader  
SINTEF Community



## Sammendrag / Summary

### Sammendrag

Dette er den andre årsrapporten fra Flexbuild-prosjektet og oppsummerer hovedfunnene fra forskningsarbeidet som ble gjort i prosjektets andre år.

### Potensial for småskala fjernvarme og storskala fjernvarme (kapittel 2)

For det andre året i Flexbuild-prosjektet er modelleringen av den norske bygningsmassen delt inn i fem ulike regionale spotprisområder, NO1 til NO5. Videre har vi identifisert dagens og framtidig potensial for bygninger som betjenes av fjernvarme. For å konkludere måtte vi undersøke det geografiske potensialet for fjernvarmeforsyning, som oppsummert i figur 1.

1. På tilbudssiden: Ikke alle områder kan betjenes med fjernvarme i framtiden. Hvert markedsområde for strøm i Norge måtte dermed deles inn i tre delområder:
  - Delområdet med storskala fjernvarme er basert på Statistisk sentralbyrås definisjon av "byer". Dagens fjernvarmeanlegg som genererer  $> 100$  GWh/år, er definert som storskala.
  - Delområdet med småskala fjernvarme er basert på Statistisk sentralbyrås definisjon av "tettbygde strøk". Dagens fjernvarmeanlegg som produserer  $< 100$  GWh/år, er definert som småskala.
  - Delområdet med ingen termiske nettverk er basert på Statistisk sentralbyrås definisjon av "spredtbygde strøk", og for disse områdene antar vi at varmetetthet er for lav til å rettferdiggjøre utviklingen av fjernvarmenett.
2. På etterspørselssiden: Ikke alle bygg har eller kan ha et vannbåret varmesystem. Dette førte til følgende modelleringsantakelser og valg:
  - Andelen eksisterende bygninger med vannbåret varme er ca. 40 % for boligblokker og ca. 60 % for næringsbygg, basert på tilgjengelig statistikk om oppvarmingsteknologi og forbruk av fjernvarme. I nybygg antas andelen å bli ca. 90 % for både boligblokker og næringsbygg.
  - Det totale volumet av tilkobling til fjernvarmenettet til boligbygg er tildelt boligblokker. Dette er gjort for å være konsekvent med statistikken på bruk av energibærere og samtidig forenkle modelleringen. Det er et lite volum fjernvarme som blir levert til eneboliger. Samtidig er dette ikke en attraktiv kategori for utvidelse av fjernvarmenettet.

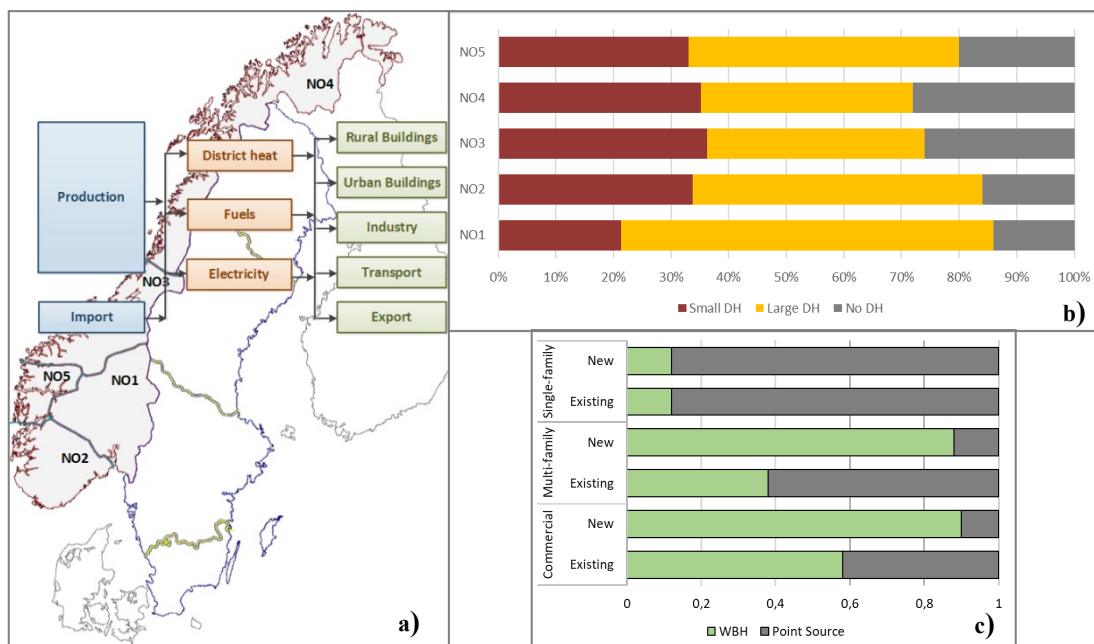

Figur 1. a) Illustrasjon av Flexbuild-områder. b) Maks andel leiligheter som kan bli koblet til småskala, storskala og ingen fjernvarmenett per område. c) Dagens andel av bygninger med vannbåret oppvarming og punktkildeoppvarming

Kombinasjonen av disse to variablene resulterte i at vi kunne identifisere vekstpotensialet for fjernvarme i bygg fram til 2030. Det samlede resultatet viste at potensialet kunne fordobles fra dagens 4,0 TWh til 10,3 TWh i 2030, hvor:

- småskala fjernvarme har størst vekstpotensial, fra dagens 1,8 til 4,8 TWh i 2030 (nesten tredobbel økning)
- storskala fjernvarme kan øke fra dagens 3,2 til 5,5 TWh i 2030
- etterspørselen fra næringsbygg etter fjernvarme kan øke fra dagens 3,4 til 8,1 TWh i 2030, fordelt på:
  - småskala: fra dagens 1,1 til 3,7 TWh i 2030
  - storskala: fra dagens 2,2 til 4,4 TWh i 2030
- etterspørselen fra boligblokker etter fjernvarme kan øke fra dagens 1,5 til 2,2 TWh i 2030, fordelt på:
  - småskala: fra dagen 0,7 til 1,0 TWh i 2030
  - storskala: fra dagens 0,9 til 1,3 TWh i 2030

Med andre ord: Geografisk sett er det største potensialet for fjernvarme å finne i utkant-områder i byer eller i tettsteder, hvor varmetettheten er høy nok til at vekstpotensialet for ny småskala fjernvarme er økonomisk attraktivt. I sentrale deler av store byer er varmebehovet til boligblokker allerede nesten mettet for storskala fjernvarme.

### Utvikling av bygningsmassen (kapittel 3)

Modelleringen av bygningsmassen avdekket hvordan bygningsmassen endrer seg langsomt i alle storylines. Det bør nevnes at ingen storylines er ment å representere maksimalt energisparepotensial, selv om storyline "Klimapanikk" innfører noen radikale tiltak, men det er først etter 2030. Snarere er alle storylines ment å gi realistiske alternativer, selv om de følger ulike mønstre.

Mengden rehabiliteringsarbeid (ca. 1 % per år) er hentet fra historiske trender, og omfanget forventes å øke noe i takt med aldringen av bygningsmassen. Imidlertid vil ikke all rehabilitering ha innvirkning på bygningens energieffektivitet. Den tilgjengelige kunnskapen tyder på en meget lav grad av oppgradering, det vil si rehabilitering som betydelig forbedrer bygningens klimaskjerm (som vegg- og takisolasjon, bedre vinduer og lufttetthet), i størrelsesorden

0,2 % per år. Graden av energieffektive oppgraderinger er holdt konstant i storyline "Petroleumsnasjon" og økt til størrelsesorden 0,3 til 2,0 % i de andre storylines.

### Utvikling av energibehov (kapittel 3)

PROFet (lastprofilestimator for energibehov) gir kun tre nivåer for energieffektivitet: vanlig, effektiv og veldig effektiv. Alle bygninger som er bygd før 2010, antas å ha vanlig standard, noe som gjenspeiler et gjennomsnittlig energiforbruk i dagens bygningsmasse. Vi antar at en oppgradering av disse bygningene kun gir en oppgradering til nivået "effektiv" (tilsvarende standarden i TEK10), men aldri til "veldig effektiv" (tilsvarende passivhusstandard). Alle bygninger bygd etter 2010 er energieffektive og antas å ikke bli rehabilitert før i 2050. I alle storylines unntatt "Petroleumsnasjonen" er standarden til nye bygg antatt til å være "veldig effektiv" (tilsvarende passivhusstandard) i 2020 eller 2030. Figur 2 oppsummerer resultatene i henhold til sammensetningen av gulvarealet til bygningsmassen.

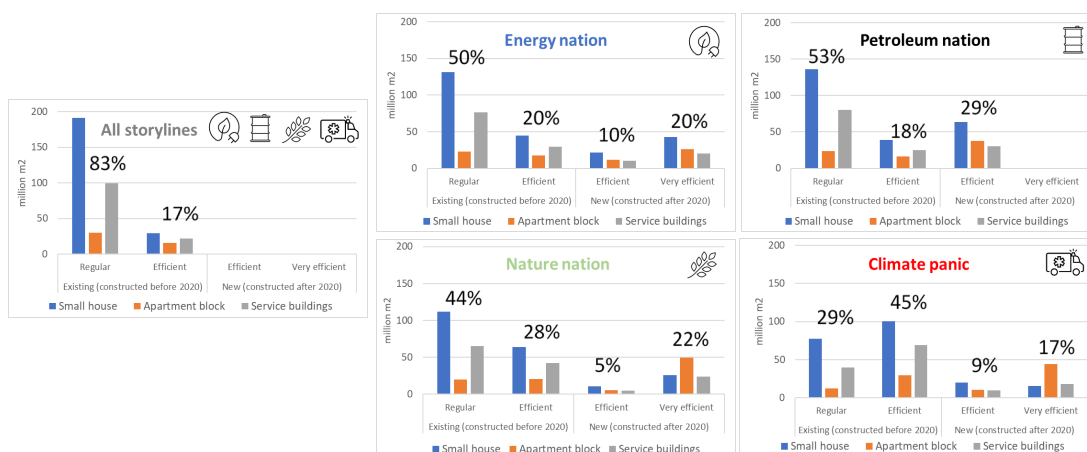

Figur 2. Sammenstilling av bygningsmassen per bygningstype og energieffektivitetsnivå i år 2020 og 2050 for hver storyline

Ifølge alle storylines vil ca. 70 % av bygningsmassen i 2050 bestå av bygninger som allerede eksisterer i dag. Disse bygningene vil være ansvarlig for ca. 80 % av det samlede energibehovet. Vi presiserer at dette gjelder energibehov for spesifikke tjenester som romoppvarming, varmtvann og el-spesifikt forbruk. Energieffektive teknologier som varmepumper påvirker levert energi, men ikke energibehovet til et bygg. Det konkrete valget av oppvarmingsmetode og annen teknologi som skal brukes, er ikke inndata i storylines, men et resultat fra modelleringen. For det andre året i Flexbuild-prosjektet har dette vært et resultat av TIMES-Norge-modellen, basert på prinsippet om kostnadsoptimalisering for hele energisystemet.

For å beregne utviklingen av det totale energibehovet for bygningsmassen i hver storyline har vi opprettet timeprofiler ved bruk av PROFet-modellen (lastprofilestimator for energibehov). PROFet estimerer timeprofiler for både termiske laster (romoppvarming og varmtvann) og elektriske laster, basert på utetemperaturer og bygnings gulvareal. Figur 3 viser et eksempel på resultater for en typisk leilighet.

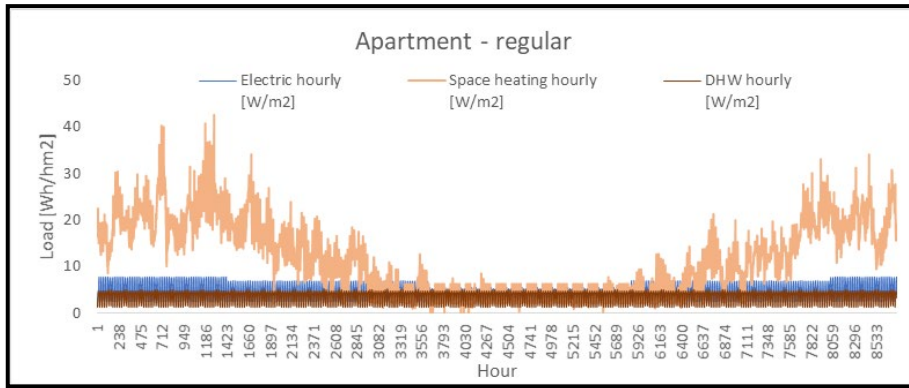

Figur 3. Årlige lastprofiler for en typisk leilighet med vanlig energieffektivitet for et typisk år, fordelt på romoppvarming, varmtvann (DHW) og spesifikk elektrisk last(Wh/hr/m<sup>2</sup>)

### Kalibrering av år 2020 (kapittel 2)

For å kalibrere bygningsmassemodellen for år 2020 mot nasjonal statistikk for energibruk har vi generert lastprofilen for bygningsmassen ved å bruke en standard værprofil (fra NS 3031) og andelen kjente oppvarmingsteknologier (fra statistikk og andre kilder) til de ulike bygningskategoriene. Denne kalibreringen har gitt meget gode resultater, som vist i figur 4, tatt i betraktning at feilestimatet er < 0,5TWh/år ved fordeling per bygningskategori (bolig og næringsbygg) og energibærer ved en total energibruk på 80 TWh/år. Resultatet kan også betraktes som en indirekte validering av PROFet-modellen som, selv om den er basert på målinger, ennå ikke har blitt sammenliknet med statistikk på dette aggregeringsnivået: egentlig hele Norges bygningsmasse.

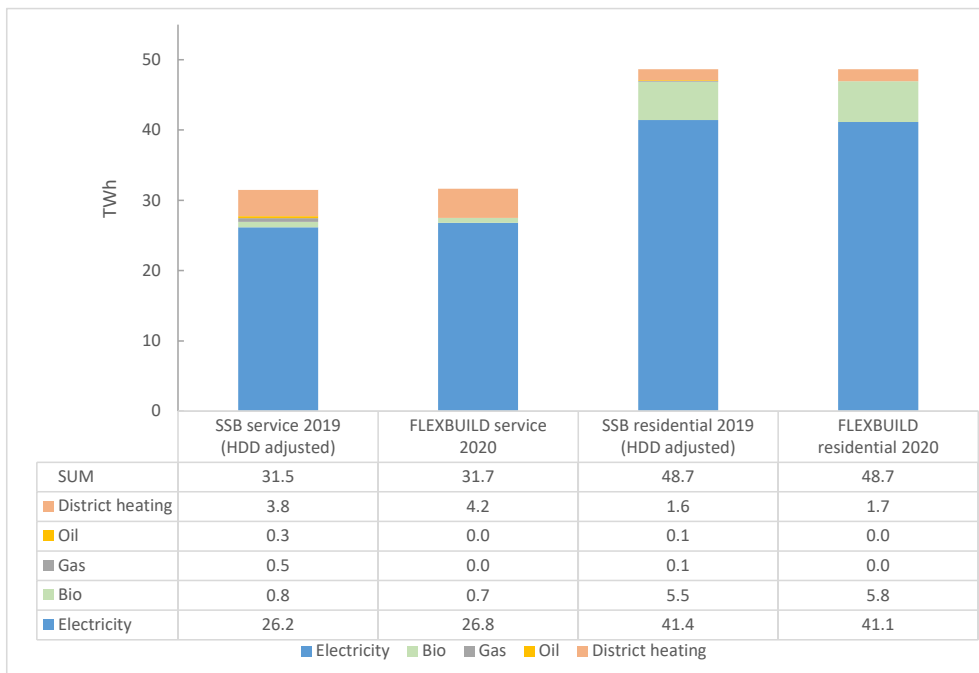

Figur 4. Levert energi i Norge i 2020. Sammenlikning (justert for temperatur) av energistatistikk i 2019 (Statistisk sentralbyrå) med Flexbuilds modellerte levert energi, fordelt på næringsbygg og boligbygg

### Resultater fra TIMES-Norge-modellen (kapittel 6)

Modelleringsresultatene av det norske energisystemet, med TIMES-Norge-modellen, er vist i figur 5. Levert energi i bygningssektoren i 2050 er lavere enn 2020 for alle storylines, unntatt "Petroleumsnasjonen" på grunn av oppgraderinger, utvidelse av fjernvarmenett og mer utstrakt bruk av varmepumper og solcellesystemer (figur 5 a). Mens elektrisitetsforbruket i bygninger reduseres mellom 1 og 7 TWh, avhengig av storyline, øker den totale sluttbruken av elektrisitet mellom 23 og 88 TWh fra 2018 til 2050 på grunn av det økte forbruket fra industri-, transport-



og hydrogenproduksjonssektorene (Figur 5 b). Det bør bemerkes at produksjon fra bygnings-anvendte solcellesystemer er inkludert, og dermed er produksjonen vist i figur 5 c) høyere enn elektrisitetsproduksjonen (og forbruket) vist i figur 5 a og b.

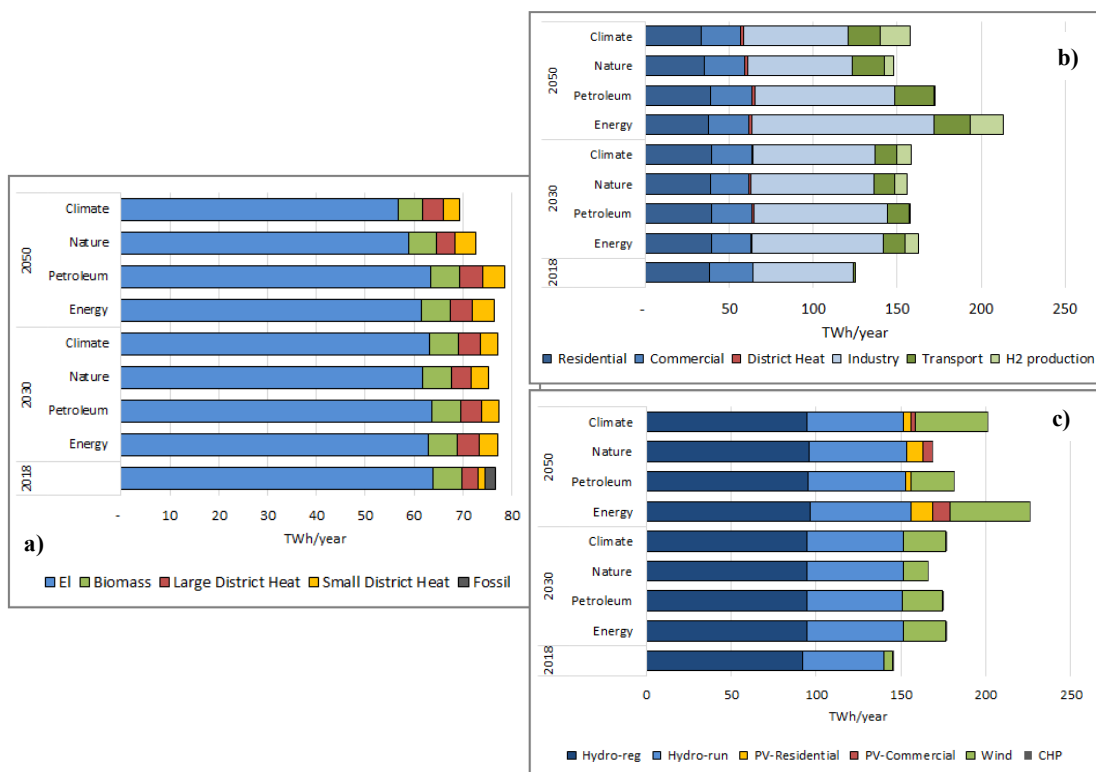

Figur 5. År 2018, 2030 og 2050 for hver storyline (TWh/år). a) Levert energi i bygg, b) Elektrisitetsforbruk i alle sektorene, c) Elektrisitetsproduksjon i Norge

Andelen PV i strømproduksjon i 2050 utgjør mellom 2 og 10 %, mens vindkraft utgjør mellom 0 og 21 %. Forskjellen mellom storylines indikerer dermed at sammensetningen av elektrisitetsproduksjon i en lavutslippsframtid er avhengig av både tilbud og etterspørsel. Hvis energibehovet er så lavt som i "Naturnasjon", kan dette dekkes kun med solceller, og det er mindre behov for ytterligere produksjon av ny fornybar energi. På den andre siden, i "Energinasjonen" fører økt energibehov fra industrien til at investeringen i både vind og solceller økes med høyeste kapasitet.

For å kvantifisere verdien av sluttbrukerfleksibilitet for det norske energisystemet har vi estimert verdien ved å utvide kapasiteten til fjernvarmekapasitet, stasjonære batterier og ved å tillate delvis fleksibelt elektrisitetsforbruk av varmtvannsberedere. Merk at merverdien av fleksibilitetsalternativene inkluderer tilleggskostnadene knyttet til bruk av denne fleksibiliteten, eksempelvis investeringskostnaden for stasjonære batterier.

Energisystemverdien av disse fleksibilitetsiltakene, etter effekten på energisystemkostnader fra 2018 til 2050, er presentert i figur 6. Merk at verdien av alle tre fleksibilitetsalternativene sammen ikke nødvendigvis er summen av de enkelte verdiene.

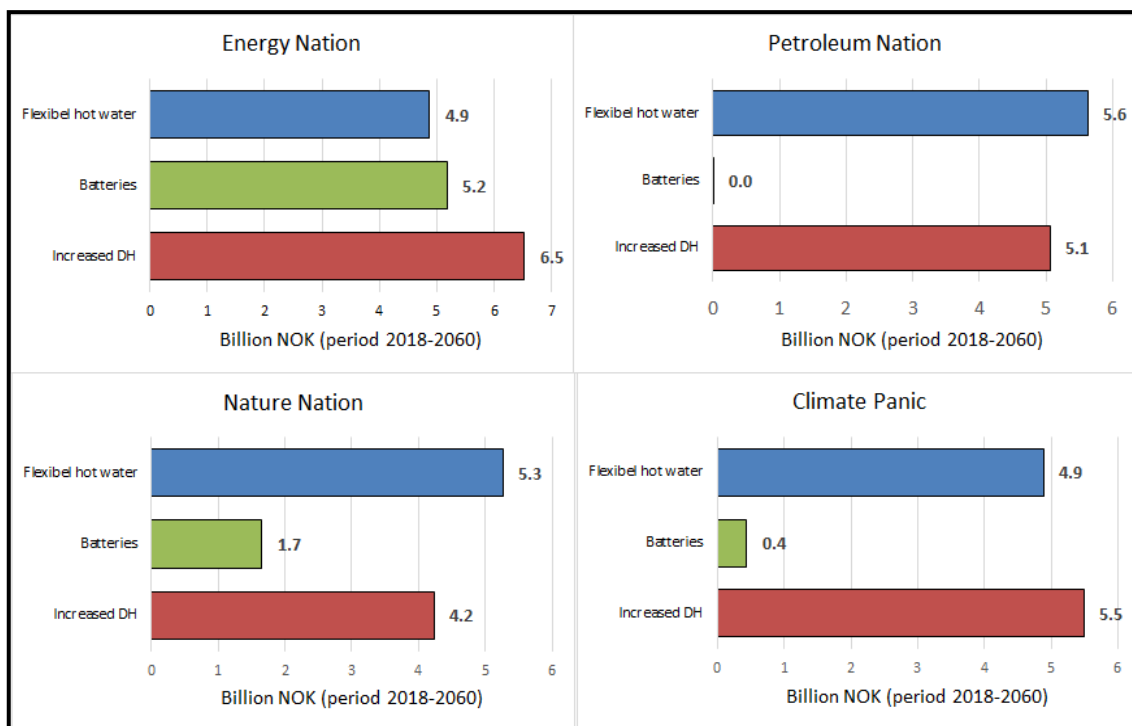

Figur 6. Energisystembesparelser i perioden 2018–2060 grunnet fleksibel elektrisk varmtvannsbereder, stasjonære batterier og økt bruk av fjernvarme. Tall i milliarder NOK

Figuren viser at verdien av sluttbrukerfleksibilitet er avhengig av storyline, spesielt usikkert er verdien av batterier i det framtidige energisystemet. Derimot kan det konkluderes med at sluttbrukerfleksibilitet har positiv verdi for energisystemet ved å redusere topplasten og fremme integrering av bygningsanvendte solcellesystemer.

### Resultater fra BUTLER (kapittel 8)

På etterspørselssiden var det ikke mulig å gjennomføre en fullverdig modellering av fleksibiliteten i hele bygningsmassen siden modelleringskapasiteten er under utvikling. En casestudie har blitt gjennomført på et enkeltbygg, som er representativ for en typisk leilighet med normalt effektivitetsnivå og med panelovner som oppvarmingskilde (62 % av bygningsmassen). I studien var det mulig å studere effekten av ulike fleksibilitetskilder ved å aktivere dem én om gangen, så vel som samlet, for så å undersøke hvordan energibehovet avvek fra baseline/grunnlinje til PROFet-modellen. De fleksibilitetskildene som er vurdert, er varmtvannstanken (DHW), romoppvarming (SH) – ved å la innetemperaturen svinge oppover i forhold til baseline/grunnlinjen og dermed bruke bygningens klimaskjerm som et "varmebatteri" samtidig som brukernes komfort ivaretas – og lading av elektrisk kjøretøy (EV). De to første (termiske) alternativene inkluderer tilhørende tap på grunn av høyere temperatur for å gi fleksibilitet, mens EV-alternativet i denne modelleringen ikke medfører noe tap. Det er antatt bruk av 0,4 EV per husholdning, eksempelvis 10 EV i en blokk med 24 leiligheter.

Fokuset har kun vært på strømforbruk, og fleksibilitet ble aktivert med to alternative mål:

1. Minimere driftskostnadene for brukeren, inkludert spotpris og nettariff, på bakgrunn av to forskjellige nettariffer<sup>1</sup>:
  - a. Energipriser, med et fastledd og et energiledd
  - b. Månedlig topplast, med et fastledd, et energiledd og et topplastledd som varierer hver måned
2. Etterstrebe en flat forbrukerprofil (minimere både strømforbruk og variasjoner av strømforbruk), som er tariffuavhengig siden den kun er basert på faktisk forbruk.

<sup>1</sup> Oppgitt av Elvia

Figur 7 viser resultatene ved å aktivere alle kildene for sluttbrukerfleksibilitet med ulike mål, for en kald uke i desember.

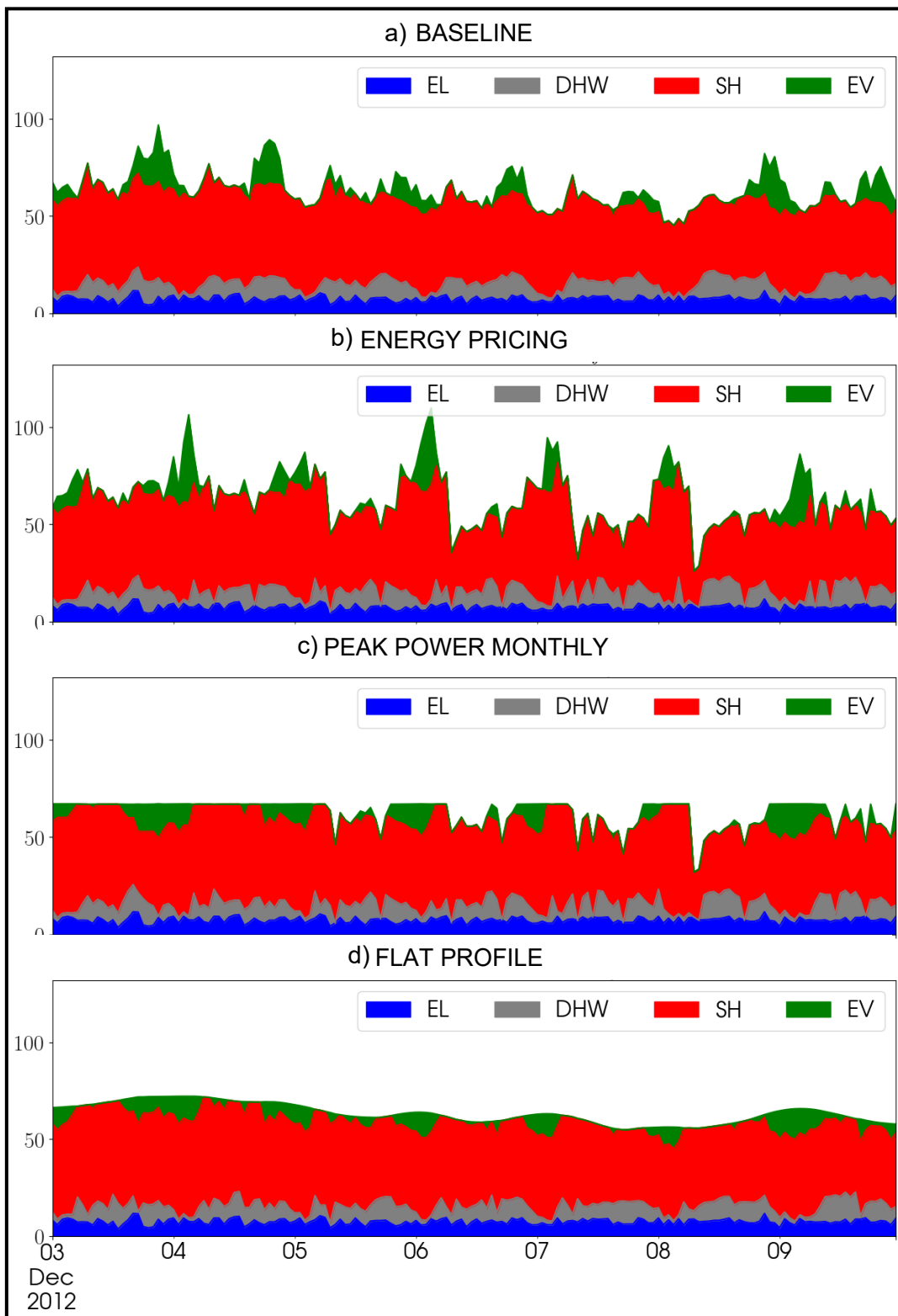

Figur 7. Timesprofiler av strømforbruk (kWh/h) for en leilighet med vanlig energieffektivitet og panelovn som oppvarmingskilde, for en uke i desember. Grafen på toppen viser typiske behov (a) Baseline, det vil si PROFet lastprofiler, mens b)–d) viser resultatet av å aktivere kildene for sluttbrukerfleksibilitet med ulike mål: minimere kostnad med to ulike nettarriffer, (b) energipris eller c) månedlig topplast, og i tillegg minimere d) strømforbruk (flat profil).

Effektene av fleksibilitet, målt i form av kostnad og topplast etterspørsel for et helt år med simulering av drift, resulterte i disse konklusjonene:

- Med nettariff for energipriser:
  - Når man etterstreber minimumskostnader, oppnås kun marginale besparelser i størrelsesorden -1 %, og dette skjer på bekostning av å øke topplast med opptil + 27 % (selv om det forskyves til de billigste timene).
  - Når man etterstreber en flat profil, er det derimot mulig å redusere topplast med opptil -24 % uten noen betydelige merkostnader (~ 0 %).

I begge casene skyldes den marginale kostnadsvariasjonen de lave svingningene i spotprisen (historiske data for året 2012 ble brukt).

- Med en månedlig topplast tariffpris:
  - I alle casene er det mulig å oppnå både kostnadsbesparelser og topplastreduksjon, med de beste resultatene når målet er å minimere kostnadene.
  - Den beste casen oppnår -31 % topplast med -6 % kostnadsbesparelser når alle tre fleksibilitetskildene er aktivert samtidig.
  - Kun med romoppvarming oppnås -19 % topplast med -4 % kostnader.

Ved å vurdere de tre kildene for sluttbrukerfleksibilitet separat og ved å se på topplastreduksjon som indikator kan vi skissere følgende omfang og rangering av fleksibilitetskilder:

1. Elektriske kjøretøy (-19 %)
2. Romoppvarming (-12 til -19 %)
3. Varmtvannstank (-8 %)

De beste resultatene med hensyn til topplastreduksjon og tilsvarende kostnadsminimering for brukerne oppnås når vi følger målet om å minimere kostnadene med en månedlig topplast-nettariff. Derimot fører en nettariff for energipriser til en moderat reduksjon av kostnadene og samtidig en betydelig økning av topplaster (selv om topplastene er forskjøvet til timer med lav strømpris). Et mulig alternativ er å aktivere fleksibilitet med et annet mål enn kostnadsminimering, det vil si å oppnå et så lavt energibehov som mulig (uten å øke tapene for mye, ved å følge et minimalt energibruk med minimal time-for-timevariasjon). "Flathetsmålet" er tariffuavhengig fordi det kun påvirkes av fysiske variabler. Dette viser gode resultater når det gjelder reduksjon av topplaster (men dårligere enn kostnadsminimering ved bruk av månedlig topplast-tariff), og gir ingen vesentlige kostnader for brukeren (i størrelsesorden 1 %).

## Summary

This report is the second annual report within the FlexBuild research project and summarises the main findings from the executed research work within the project's second year.

### Potential for local (small) and district (large) heating network (chapter 2)

In the second year of FlexBuild, the modelling of the Norwegian building stock has been regionally divided into the current five spot price regions of Norway, NO1 to NO5. Furthermore, we have also identified the current status and future potential for buildings being served by district heating. To conclude on this, we had to investigate the geographical potential for district heating supply, as summarized in Figure 1:

1. On the supply side, not all the geographical areas are, or can be served by district heating in the future. This, in turn, resulted in subdividing each electricity market area of Norway into three sub-areas, namely:
  - Large-scale district heating (*fjernvarme storskala*) sub-area, is based on the Statistics Norway definition of "cities". The current district heating plants that generate > 100 GWh/year are defined as large-scale.
  - Small-scale district heating (*småskala fjernvarme*) sub-area, is based on the Statistics Norway definition of "tightly populated areas", and current district heating plants that generate < 100 GWh/year are defined as small-scale.
  - No Thermal Network (*ingen fjernvarme*) sub-area, is based on Statistics Norway's definition of "sparsely populated areas", and for these areas we assume that the heat density is too low to justify the development of thermal networks.
2. On the demand side, not all buildings have, or can have, a waterborne heating system. This, in turn, resulted in the following modelling assumptions and choices:
  - The percentage of existing buildings having waterborne heating is ca. 40% for Apartments and ca. 60% for Commercial buildings, based on available statistics on heating technologies and consumed district heating. In new buildings, this is assumed to become ca. 90%, for both Apartments and Commercial buildings.
  - The total volume of district heating connection going to residential buildings is allocated to Apartments. This is done to keep overall consistency with the statistics on energy carriers use, while simplifying the modelling. There is just a minor volume of district heating being delivered to single family houses, and at the same time this is not an attractive category for district heating expansion.

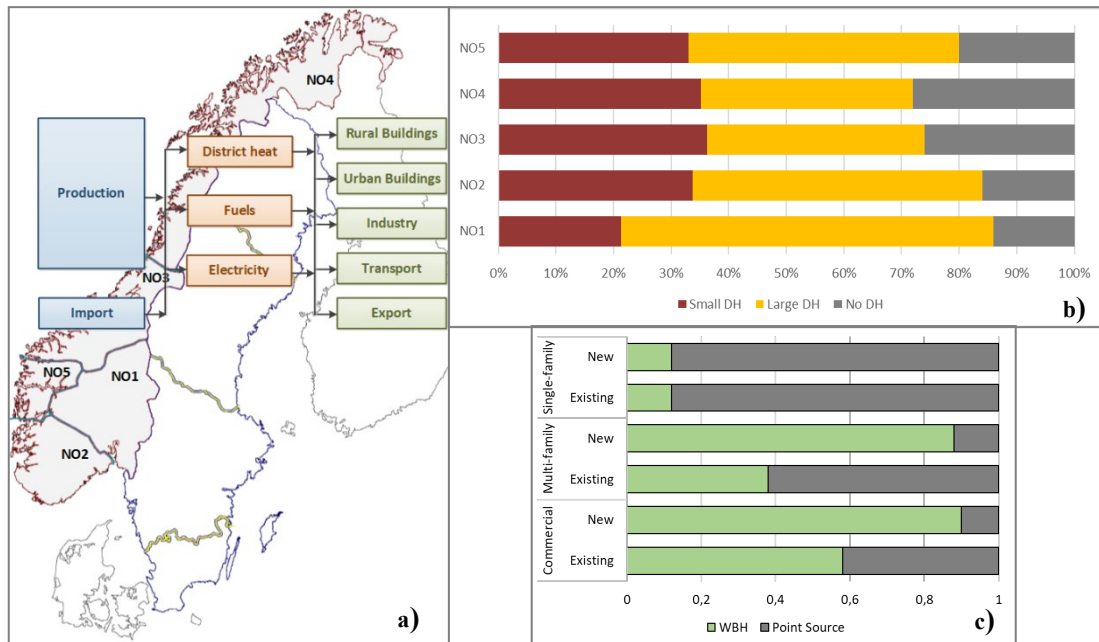

Figure 1. a) Illustration of FlexBuild regions, b) Max share of buildings that could be connected to small, large and no district heating systems per region, c) Current share of buildings with waterborne heating (WBH) and point-source heating.

The combination of these two variables led to the identification of the potential for district heating expansion in buildings towards 2030. This shows an overall doubling potential from today's 4.9 TWh to 10.3 TWh in 2030, where:

- Small-scale district heating has the largest potential for growth, from 1.8 TWh of today to 4.8 TWh in 2030 (almost a three-fold increase)
- Large-scale district heating can grow from 3.2 TWh of today up to 5.5 TWh in 2030
- Commercial buildings demand for district heating can grow from 3.4 TWh of today up to 8.1 TWh in 2030, so parted:
  - Small-scale: from 1.1 TWh today to 3.7 TWh in 2030
  - Large-scale: from 2.2 TWh today to 4.4 TWh in 2030
- Apartment blocks demand for district heating can grow from 1.5 TWh of today up to 2.2 TWh in 2030, so parted:
  - Small-scale: from 0.7 TWh today to 1.0 TWh in 2030
  - Large-scale: from 0.9 TWh today to 1.3 TWh in 2030

In other words, geographic-wise the largest potential is on peripheral areas of cities or in smaller centres, where the heat density is high enough to make the potential for new small-scale district heating economically attractive. In the inner part of large cities, the heat demand by Apartment blocks is already nearly saturated by large-scale district heating.

### Building stock development (chapter 3)

The modelling of the building stock reveals how it changes slowly in all Storylines. It should be stated that none of the Storylines are meant to represent a sort of maximum energy conservation potential, although the 'Climate panic storyline' does adopt some radical measures, but only after 2030. Rather, all Storylines are meant to be realistic alternatives towards a substantially decarbonized energy system towards 2050, though following different narratives.

The amount of renovation, in particular, is taken from historical trends (about 1% per year) and is expected to slightly increase due to the ageing of the stock. However, not all renovation that occur have an impact on the energy efficiency of the building. The available knowledge points at a very low rate of deep-renovation, that substantially improves the thermal properties of a building's envelope (such as walls and roof insulation, better windows and airtightness),

on the order of 0.2% per year. The rate of renovation with energy-efficiency is kept constant in the Petroleum nation storyline and increased to levels between 0.3 and 2.0% in the other Storylines.

### Energy demand development (chapter 3)

The PROFet (energy demand load profiles estimator) only provides three levels of energy efficiency, namely: Regular, Efficient and Very efficient. All buildings built before 2010 are assumed to have Regular standard, reflecting an average energy consumption of the current building stock, and we assume that these buildings may only be upgraded to the Efficient level (similar to the TEK10 building code), but never to the Very efficient level (similar to the Passive House standard), when deep-renovation occurs. All buildings built after 2010 are Efficient, and are not assumed to undergo renovation until 2050. In all storylines, except the 'Petroleum nation', the standard of new buildings is assumed to become Very efficient (similar to the Passive House standard), in 2020 or 2030. Figure 2 summarizes the results in terms of floor area composition of the building stock.

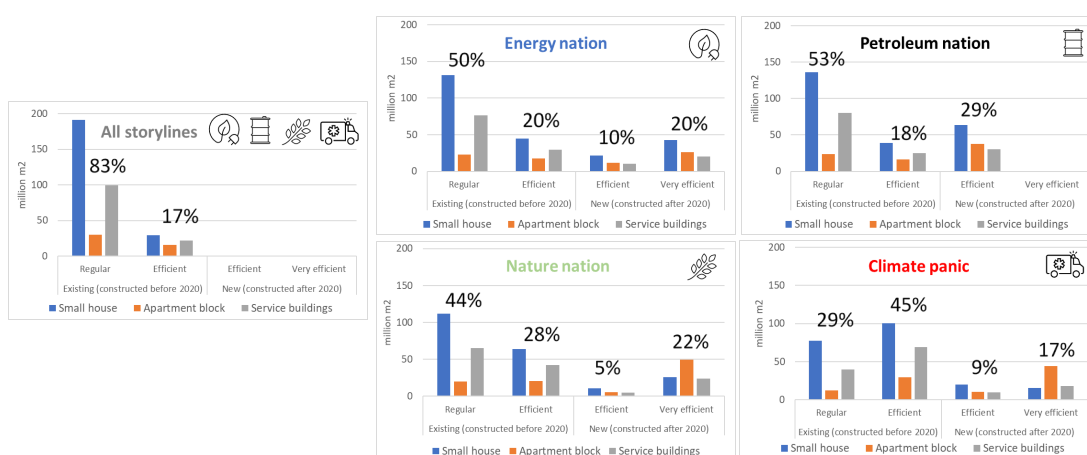

Figure 2. Building stock composition per building type and energy efficiency level in year 2020 and in year 2050 for each storyline.

In all Storylines in 2050 the building stock will consist of ca. 70% of buildings already existing today, which will be responsible for ca. 80% of the energy demand. It should be reminded that here we are talking of energy demand for specific services, such as space heating, domestic hot water and electric specific loads. The adoption of energy efficient technologies, such as heat pumps, affects the energy use (NO: energibruk eller levert energi) but does not affect the energy demand (NO: energibehov) of a building. The actual choice of which heating and other technologies to apply, is not a Storyline input but is an output of the modelling work. Specifically, in this second year, this has been an outcome of the IFE-TIMES-Norway model, based on the principle of cost optimality for the entire energy system.

To calculate the development of the total energy demand for the building mass in each storyline hourly profiles have been created using the PROFet model (energy demand load profile estimator). PROFet estimates hourly load profiles for both thermal loads (space heating and Domestic Hot Water) and electric loads, based on outdoor temperatures and buildings' floor area. See Figure 3 for an example of results for a typical Apartment.

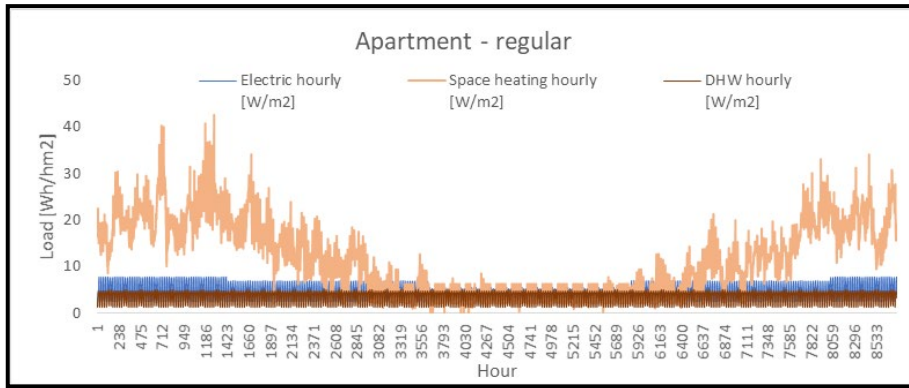

Figure 3. Annual load profile for a typical Apartment block with Regular efficiency for a typical climatic year. Separated on space heating, domestic hot water (DHW) and electric specific demand. (Wh/hr/m<sup>2</sup>)

### Calibration of year 2020 (chapter 2)

To calibrate the building stock model for year 2020 against national energy use statistics, the load profile for the building mass has been generated by applying a standard weather profile (from NS3031) and the known share of heating technologies (from statistics and other sources) to the various building categories. This calibration has shown very good results, as shown in Figure 4, considering that in the breakdown per building category (Residential and Commercial) and energy carrier, the error is < 0.5 TWh/y, on a total energy use of 80 TWh/y. This may be seen also as an indirect validation of the PROFet model that, although based on measurements, had not yet been compared with statistics at this level of aggregation: indeed, the whole Norway's building stock.

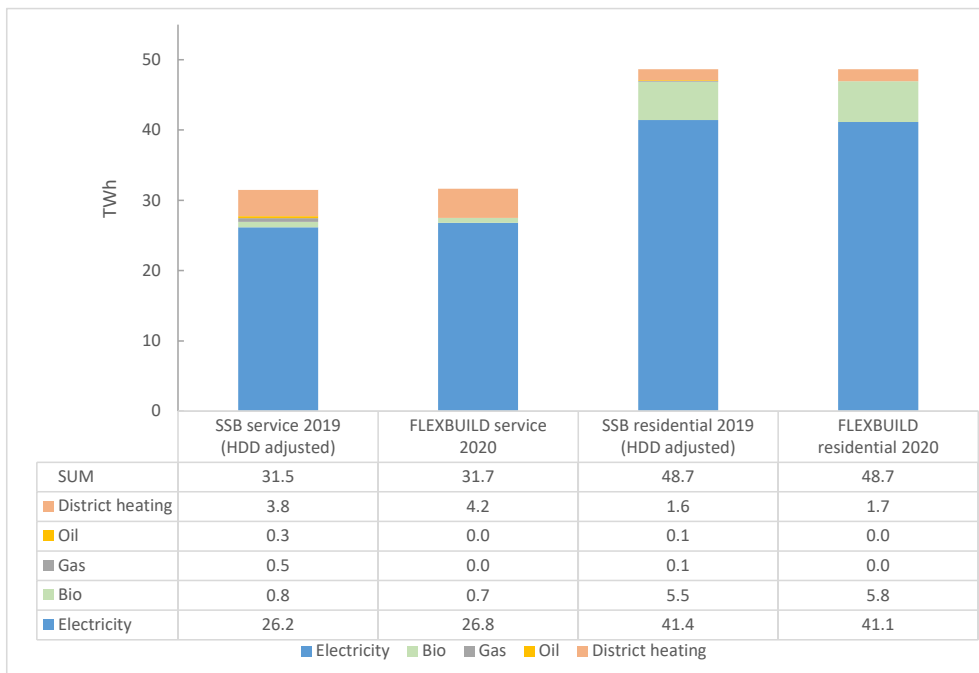

Figure 4. Norway's energy use in 2020. Comparing temperature adjusted energy statistics in 2019 (Statistics Norway), to FlexBuild's modelled energy use. Separated on service buildings and residential buildings.

### IFE-TIMES-Norway results (Chapter 6)

The results of modelling of the Norwegian energy system, with the IFE-TIMES-Norway model, are shown in Figure 5. Energy use in the building sector in 2050 is lower than in 2020 in all storylines, except the Petroleum nation, due to renovations, expansion of district heating and higher penetration of heat pumps and PV, Figure 5 a). However, while electricity use in buildings decreases between 1 and 7 TWh, depending on the storyline, the total end-use of



electricity increases between 23 and 88 TWh from 2018 to 2050 due to the increased consumption by the Industry, Transport and Hydrogen production sectors, Figure 5 b). The electricity generation increase towards 2050 between 24 and 81 TWh, again storyline dependent, Figure 5 c). It should be noted that building applied PV generation is included, thus the generation shown in Figure 5 c) is higher than the high voltage electricity generation (and consumption) shown in Figure 5 a) and b).

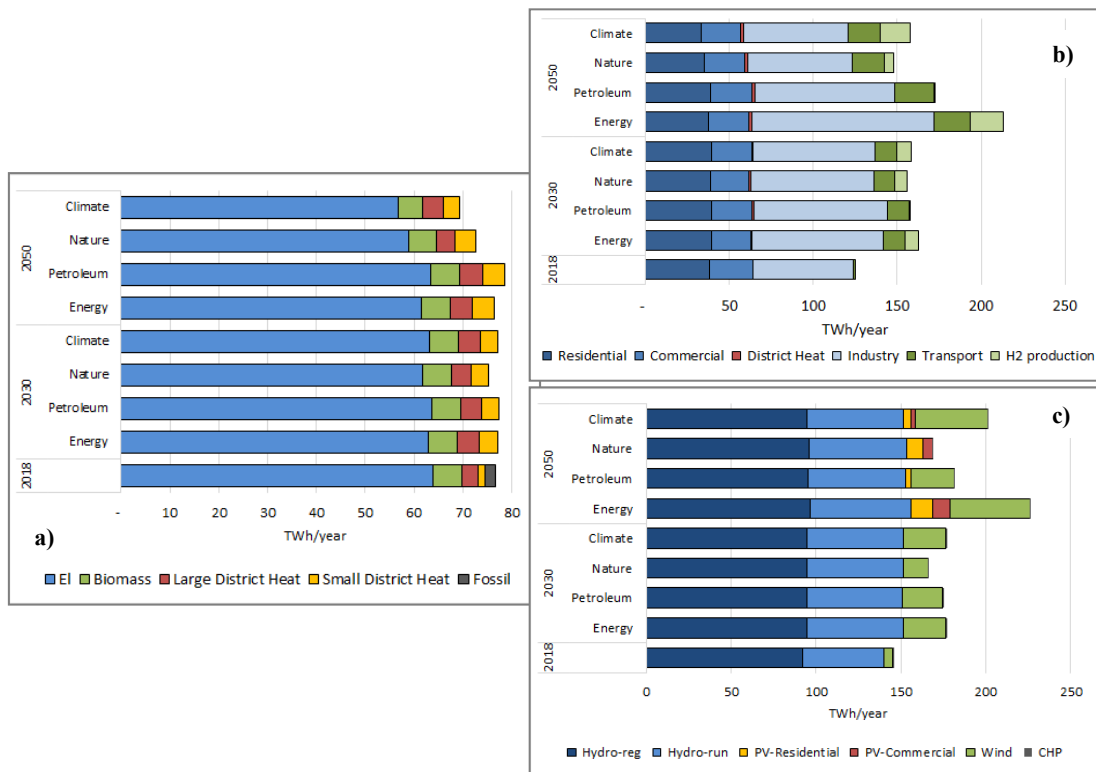

Figure 5. In years 2018, 2030 and 2050, for each storyline (TWh/y) a) Energy use in buildings, b) Electricity use in all sectors, c) Electricity generation in Norway.

The share of PV in the electricity generation mix in 2050 ranges between 2 and 10 %, while wind power ranges between 0 and 21%. Consequently, the difference among the storylines indicates that the electricity generation mix in a low-carbon future depends on both supply and demand. If energy demand is low as in 'Nature nation' additional new renewable generation is less needed and is met by PV solely. Opposite, in 'Energy nation' the increased industry energy demand, increases the investment in both wind and PV to the highest capacities.

To quantify the value of energy end-use flexibility on the Norwegian energy system, we have estimated the value of expanding district heat capacity, stationary batteries and by allowing for partly flexible electricity consumption of hot water heaters. Note that the added value of these flexibility options includes the additional costs that are related to using this flexibility, e.g. the investment cost in stationary batteries. The energy system value of these flexibility measures, by the effect on the energy system cost from 2018 to 2060, are presented in Figure 6. Note that the value of all three flexibility options together is not necessarily equal to the sum of each of the separate values.

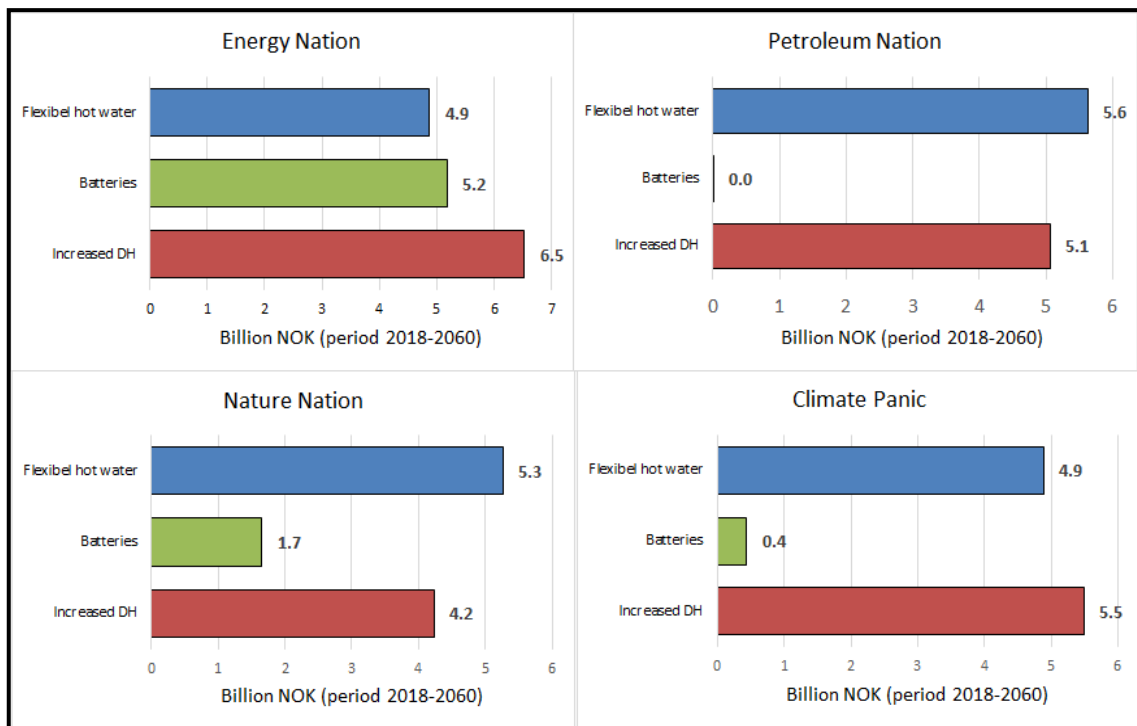

Figure 6. Energy system savings in the period 2018-2060 due to flexible electric water heater, stationary batteries and increased use of district heating. (Billion NOK).

The figure shows that the value of end-use flexibility is storyline dependent, especially the future energy system value of batteries is highly uncertain. However, it can be concluded that end-use flexibility has a positive value for the energy system, reducing peak demand and favouring integration of building applied PV.

### BUTLER results (chapter 8)

On the demand side, a full modelling of the energy demand flexibility in the entire building stock was not yet possible since this modelling capacity is under development. A case study has been performed on a single building, representative of a typical Apartment in the Regular efficiency level and with panel ovens as heating technology (62% of the stock). Here it was possible to study the effect of different flexibility sources by activating them one at a time, as well as together, and see how this would deviate the energy demand from the PROFet baseline. The flexibility sources considered are the Domestic Hot Water (DHW) tank, the Space Heating system (SH) - allowing indoor temperature to fluctuate upwards, with respect to the baseline, thus using the thermal envelope of the building as a sort of "thermal battery" while safeguarding users' comfort – and the Electric Vehicle (EV) charging. The first two (thermal) options, come along with attached losses deriving from the upward lift of temperature to provide flexibility, while the EV option is – in this modelling – losses free. It was assumed a penetration rate of 0.4 EV per household, e.g., 10 EVs in a 24 dwellings apartment block.

The focus has been only on the electricity use, and flexibility was activated with two alternative goals:

1. Minimize operational costs for the user, incl. spot price and grid tariff, in the context of two different grid tariffs:
  - a. Energy Pricing, with a fixed-term and an energy-term
  - b. Peak Power Monthly, with a fixed-term, an energy-term and a peak power-term that varies each month
2. Pursue a flat profile of electricity use (minimize energy use while minimizing also variations in energy use), which is tariff independent since it is only based on physical quantities.

Figure 7 shows the results of activating all the end-use flexibility sources with the different goals, for a cold week in December.

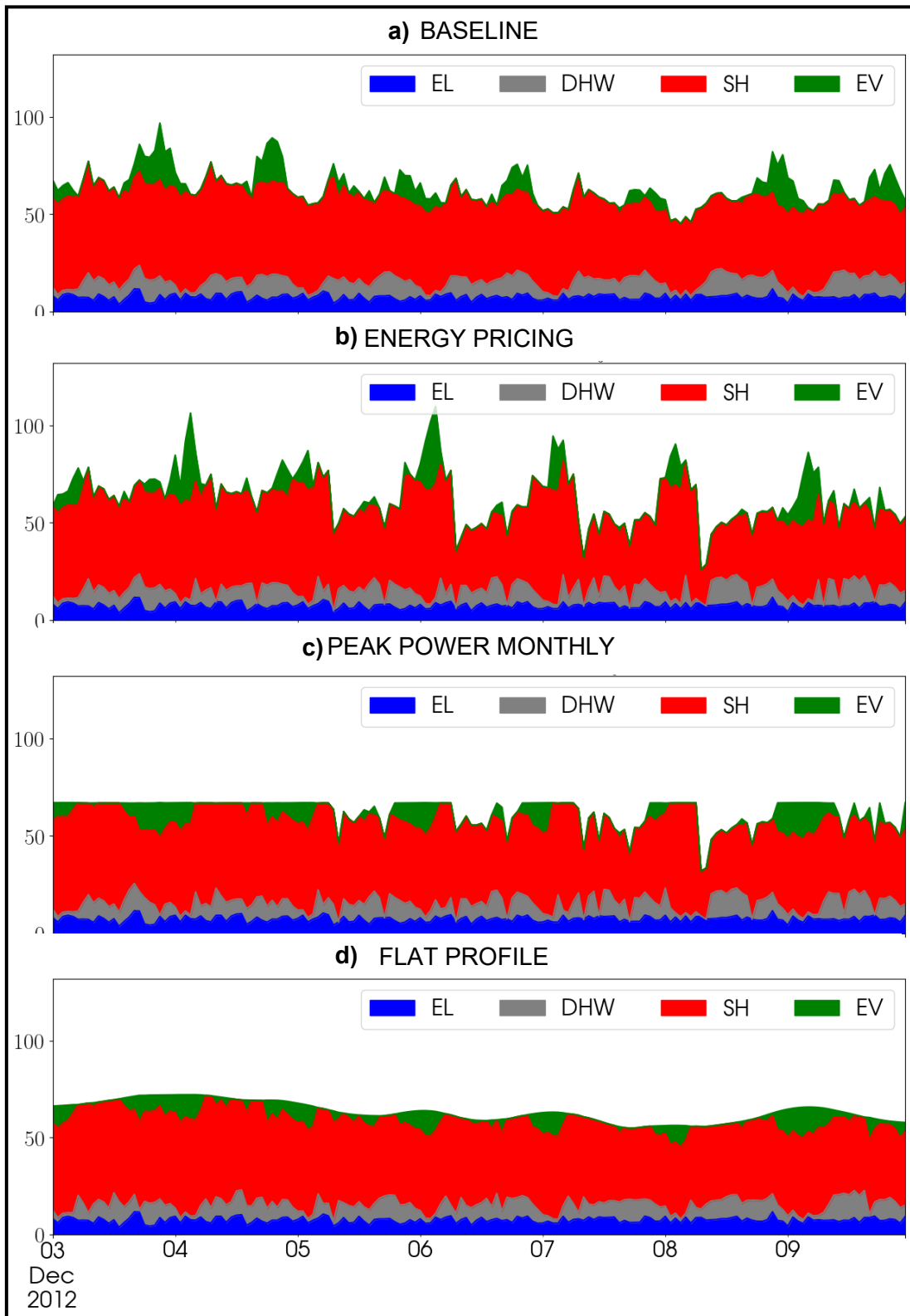

Figure 7. Hourly profile of electricity use (kWh/h) for the Apartment with Regular efficiency and Panel ovens as heating technology, in a week in December. The top plot shows the typical demand (a) Baseline), i.e. the PROFet load profiles; while b)–d) show the result of activating end-use flexibility with different goals: Minimization of cost with two different grid tariffs b) Energy Pricing or c) Peak Power Monthly, and adding minimization of d) electricity variation (Flat profile).

The effects of flexibility were measured in terms of cost and peak demand, on a full year of simulated operation, leading to these conclusions:

- In the context of an Energy Pricing grid tariff:
  - when pursuing minimum cost, only marginal savings are achievable, in the order of -1%, and this happens at the cost of increasing the peak load by up to +27% (although this is shifted to the cheapest hours),
  - when pursuing a flat profile, on the contrary, it is possible to reduce the peak load by up to -24% with no significant additional cost (~0%).

In both cases, the marginal cost variation is due to the low variability of the spot price (historical data for year 2012 were used).

- In the context of a Peak Power Monthly tariff:
  - In all cases it is possible to achieve both cost savings and peak load reduction, with the best results achieved when the goal is minimizing cost,
  - The best case achieves -31% peak load with -6% cost savings when all three flexibility sources are activated together,
  - Space heating alone can achieve -19% peak load with -4% cost.

Considering the three end-use flexibility sources separately, and looking at the peak load reduction as the indicator, we may draft the following range and ranking of flexibility sources:

1. Electric Vehicles (-19%)
2. Space heating (-12 to -19%)
3. DHW tank (-8%)

The best results in terms of peak reduction, and cost minimization for the users alike, are obtained when pursuing the goal of minimizing cost with a Peak Power Monthly grid tariff. On the contrary, with an Energy Pricing grid tariff, minimization of cost harvest modest result while leading to substantial increase of the peak load (although shifted into hours of low electricity price). As a possible alternative, flexibility might be activated with the goal of obtaining an energy demand that is as flat as possible (without increasing losses too much, that is pursuing minimum energy use with minimum hour-by-hour variation). This 'flatness' goal is tariff independent because it only acts on physical variables. This shows to obtain good results in terms of peak load reduction (although less good than cost minimization with PPM tariff) while adding no substantial cost to the user (in the order of 1%).

# Contents

<b>PREFACE .....</b>	<b>3</b>
<b>SAMMENDRAG / SUMMARY .....</b>	<b>4</b>
SAMMENDRAG .....	4
SUMMARY .....	12
<b>1 INTRODUCTION AND TERMINOLOGY .....</b>	<b>22</b>
1.1 STORYLINES .....	22
1.2 TERMINOLOGY .....	22
1.3 STRUCTURE OF THIS REPORT .....	23
<b>2 MODELS LINKING AND HARMONIZATION OF INPUTS .....</b>	<b>24</b>
2.1 MODEL LINKING AND HARMONIZATION .....	24
2.2 QUANTIFICATION OF STORYLINES IN FLEXBUILD MODELS .....	26
2.3 ENERGY DEMAND MODELS: PROFET – FLEXOR – BUTLER .....	27
2.4 POTENTIAL FOR SMALL-SCALE AND LARGE-SCALE DISTRICT HEATING .....	29
2.5 STOCHASTIC MODEL INPUT .....	35
<b>3 BUILDING STOCK EVOLUTION AND CALIBRATION .....</b>	<b>36</b>
3.1 BUILDING STOCK DEVELOPMENT: RE-BUILDS .....	36
3.2 ENERGY DEMAND MODELLING AND CALIBRATION .....	43
3.3 HEATING TECHNOLOGIES AND CALIBRATION RESULTS IN 2020 .....	47
3.4 STORYLINE MODELLING .....	51
3.5 REFERENCES .....	52
<b>4 SIMULATING HEAT LOAD PROFILES IN BUILDINGS USING MIXED EFFECTS MODELS .....</b>	<b>53</b>
4.1 MIXED EFFECTS FOR BUILDINGS .....	53
4.2 RESULTS FOR SCHOOLS .....	54
4.3 DISCUSSION AND NEXT STEPS .....	55
<b>5 POWER SYSTEM IN EUROPE AND ITS INFLUENCE IN NORWAY: PRELIMINARY RESULTS FROM EMPIRE .....</b>	<b>57</b>
5.1 INTRODUCTION TO EMPIRE .....	57
5.2 EMPIRE IN FLEXBUILD .....	58
5.3 PRELIMINARY RESULTS – ENERGY NATION .....	59
5.4 FURTHER WORK .....	62
<b>6 ENERGY SYSTEM IN NORWAY: RESULTS FROM IFE-TIMES-NORWAY .....</b>	<b>63</b>
6.1 NORWEGIAN ELECTRICITY GENERATION TOWARDS 2050 .....	63
6.2 ELECTRICITY USE .....	63
6.3 ENERGY USE IN BUILDINGS .....	64
6.4 LOAD DEMAND OF BUILDINGS IN 2050 .....	64
6.5 STATIONARY BATTERIES .....	65
6.6 FLEXIBLE ELECTRIC WATER HEATER .....	67
6.7 EFFECT ON TOTAL ENERGY SYSTEM COSTS DUE TO INCREASED FLEXIBILITY .....	70
6.8 FURTHER WORK .....	71
<b>7 HYDROPOWER SYSTEM IN NORWAY: RESULTS FROM EMPS .....</b>	<b>72</b>
7.1 ECONOMIC VALUE OF FLEXIBLE SUPPLY FROM HYDROPOWER .....	73
<b>8 FLEXIBILITY POTENTIAL IN THE BUILDING STOCK: RESULTS FROM A CASE STUDY .....</b>	<b>74</b>
8.1 RESULTS .....	74
8.2 KPIS RESULTS .....	78
8.3 RESULTS AT AGGREGATED LEVEL .....	84
8.4 FURTHER WORK .....	85
<b>9 CONCLUSIONS .....</b>	<b>86</b>

<b>APPENDIX A: STORYLINE DESCRIPTIONS .....</b>	<b>91</b>
<b>APPENDIX B: PROFET.....</b>	<b>93</b>
DEVELOPMENT OF PROFET .....	94
REFERENCES .....	96
<b>APPENDIX C: BUILDING STOCK.....</b>	<b>97</b>
STOCK DEVELOPMENT SIMULATION AND MODEL INPUTS .....	97
STORYLINE INPUTS .....	100
<b>APPENDIX D: EUROPEAN POWER SYSTEM.....</b>	<b>102</b>
INPUT DATA – ENERGY NATION .....	102
NON-DISPATCHABLE PRODUCTION FOR GERMANY 2050.....	102
<b>APPENDIX E: ENERGY SYSTEM MODEL, IFE-TIMES-NORWAY .....</b>	<b>104</b>
IFE-TIMES-NORWAY MODEL DESCRIPTION .....	104
MODEL IMPROVEMENTS AND UPDATES IN YEAR 2 .....	105
STORYLINE ASSUMPTIONS FOR IFE-TIMES-NORWAY.....	108
<b>APPENDIX F: SINGLE BUILDING CASE STUDY.....</b>	<b>115</b>

# 1 Introduction and terminology

Igor Sartori (SINTEF)

## 1.1 Storylines

In the first year of the project the partners have agreed on the need to define long-term storylines, representing possible future developments for external variables influencing the modeling activities, such as the evolution of the building stock on the demand side and the availability and cost of different energy technologies on the supply side. This resulted in the identification of 4 storylines, named as shown in Figure 8, that were given in a descriptive, qualitative way, as reported in Appendix A: Storyline descriptions. All storylines aim at a substantial decarbonization of the energy system by 2050 but follow different paths.

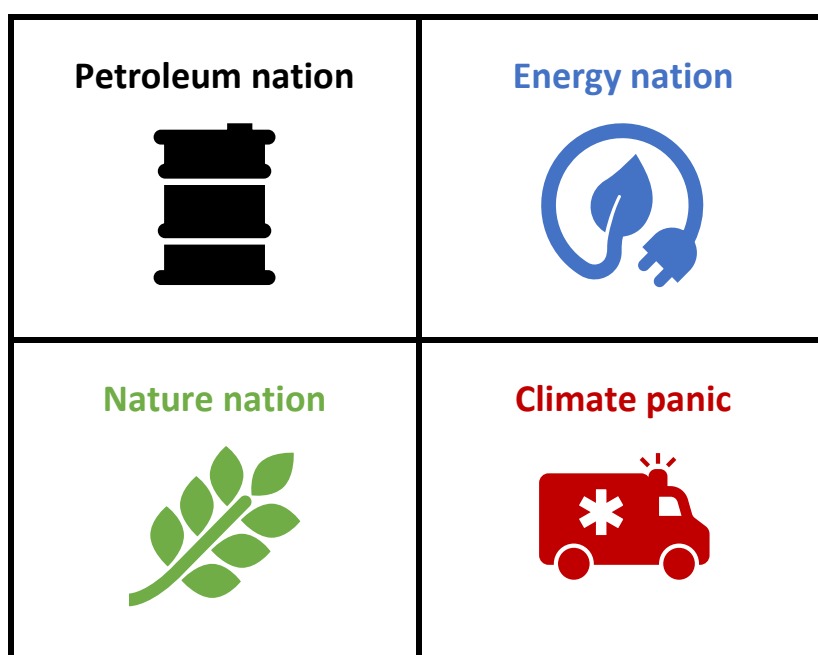

Figure 8. Names and graphical identification of the 4 storylines.

Quantification of the storylines has continued during the second year of the project, quantifying different variables in the different models, as described in the chapters 2, 3 and 5.

## 1.2 Terminology

It is useful to clarify some terminology, to avoid ambiguity and possible misunderstanding. Unfortunately, there is not a full consensus on how to use certain terms, and different fields (e.g., building physics, power system) may associate different meanings to common terms, such as demand, use, load. In this report, and in Flexbuild in general it has been agreed to use the following terminology (*Norwegian terms in italics*).

### Terminology on the building stock:

- **Residential sector** (*husholdninger*), comprises the following building categories:
  - House (*småhus*), single- and bi-family houses and row-house
  - Apartment (*boligblokk*), apartments block
- **Commercial sector / Service sector** (*næringsbygg*), comprises the following building categories:
  - Office (*kontorbygg*)
  - Shop (*forretningsbygg*)
  - School (*skole*)
  - Nursing home (*sykehjem*)
  - Other (*andre*), which is a weighted average of all other commercial categories

### Terminology on energy:

- **Energy demand** (*energibehov*) for different needs, or energy services:
  - Space Heating, SH (*rom oppvarming*)
  - Domestic Hot Water, DHW (*varmtvann*)
  - Electric specific (fans, lighting, plug loads, ...), EL (*el-spesifikk*)
  - Electric Vehicle (charging), EV (*elbil lading*)
- **Energy use** (*energiforbruk*) for different energy carriers:
  - Electricity (*elektrisitet, strøm*)
  - District Heating, DH (*fjernvarme*), and Local Heating, LH (*nærvarme*)
  - Fuels (*brensel*)

The difference between energy demand and energy use is that the energy demand for a specific need, e.g., space heating, may be met using different technologies, e.g., heat pump or gas boiler, thus resulting in different energy uses for different carriers, depending on the technology mix and the respective efficiencies.

The term **load profile** (*lastprofil*) is here meant as a generic term that refers to the hourly time series of any variable. So, for example, it is possible to speak of the load profile of DHW demand, as well as of the load profile of electricity use.

### 1.3 Structure of this report

Chapter 2 presents the status of the linking between the different models, the harmonization of inputs, especially between the building stock model (BUTLER/PROFet) and the Norwegian energy system (IFE-TIMES-Norway), with particular focus on the modelling of District Heating, which represents a novel approach developed in Flexbuild.

Chapter 3 presents the modelling of the building stock evolution and the corresponding energy demand, on annual basis, including a calibration of the model for the starting year 2020. The underlying hourly load profiles of energy demand, for space heating, hot water and electric specific, are given by the PROFet (energy demand load PROFile estimator) model.

Chapter 4 presents an alternative, and improved statistical method (namely, the mixed effect model) for defining typical load profiles out of the same sample of measurements. This is sort of a parallel work that may culminate in a second version of the PROFet model.

Chapters 5 to 7 present the main results from the energy system models: IFE-TIMES-Norway, EMPIRE and EMPS (/FANsi), respectively.

Chapter 8 presents the results for a building case study, specifically a typical Apartment block, and gives a glimpse of how energy demand may change, on an aggregated level, thanks to the activation of end-use flexibility.

Finally, chapter 9 summarizes the main conclusions from the different models and discusses the needs for future work, in the third year of the project, as identified by the researchers.



## 2 Models linking and harmonization of inputs

*Pernille Seljom, Eva Rosenberg and Lisa Kvalbein (IFE), Synne Lien, Marius Bagle, Igor Sartori and Karen Lindberg (SINTEF)*

### 2.1 Model linking and harmonization

FlexBuild uses a set of models to provide insights on the future role and value of end-use flexibility available in buildings from a Norwegian energy system perspective. To address this complex topic, we use mathematical models to systemize and concretize dependencies and competition in the future energy system. Nevertheless, since there is not one perfect model that can capture all related issues, our approach is to use a set of different models who have their own specific strengths. However, the challenge of using numerous models is that these models need to be harmonized and linked in an adequate manner to provide reasonable project insight.

An energy system covers the production, distribution, and end-use of energy. Consequently, the energy system captures the interaction and competition between different energy sources, e.g., between electricity and district heat, as well as the competition between technologies, e.g., between wind and solar power, with more intermittent renewable electricity generation and end-use electrification, the dependencies between the various sectors of the energy system increases. Each of the four FlexBuild models has different sectoral coverage, and consequently captures different aspects of the future energy system.

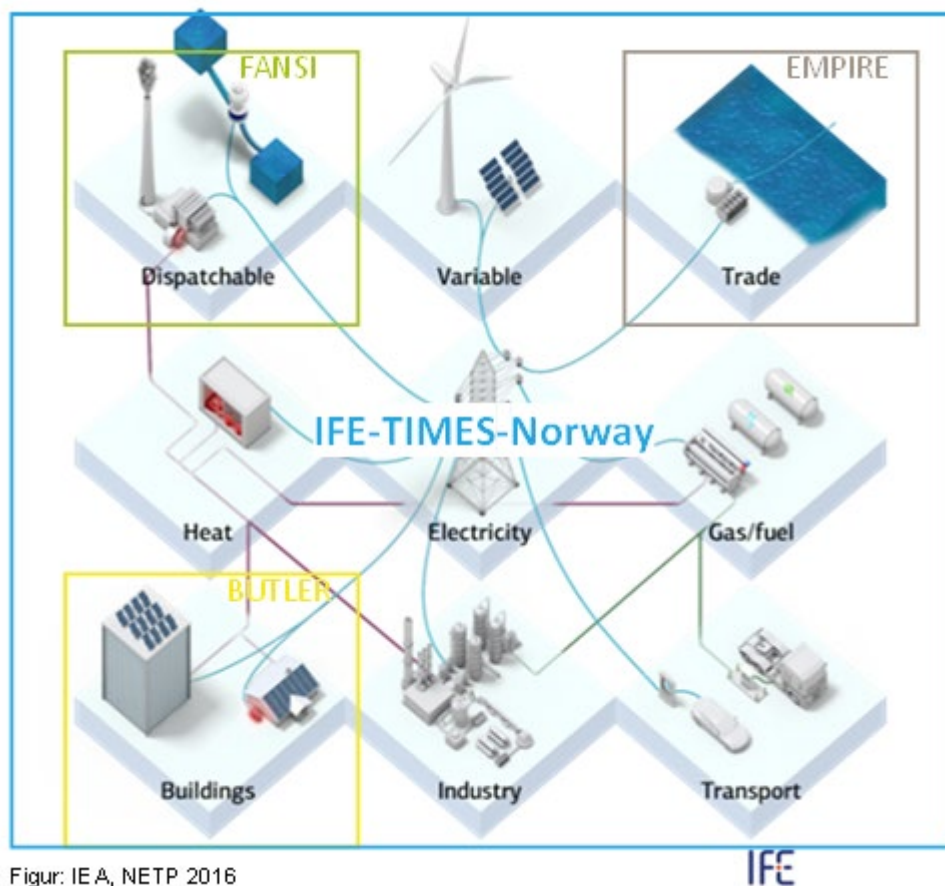

Figur: IE A, NETP 2016

Figure 9. Illustration of sectoral coverage of the various FlexBuild models

Figure 9 gives an illustration of the sectoral coverage of the various FlexBuild models. Three of the models cover parts of the Norwegian energy system, BUTLER, FanSi, and EMPIRE, whereas IFE-TIMES-Norway covers all parts and relationships of the energy system. Models that cover sub-parts of the energy system can include more detail than holistic energy system

models, such as IFE-TIMES-Norway, due to computational complexity. In FlexBuild, we use the sector-specific models to provide details of specific parts of the energy system, whereas the energy system model will be used to cover the connections between the different parts of the energy system. This includes the interaction between the Norwegian building, transport, and industrial end-use sectors with the Norwegian hydropower and European power market.

#### **Linking and harmonization of BUTLER and IFE-TIMES-Norway**

BUTLER covers the Norwegian building sector and optimizes the cost-optimal energy and flexibility solutions in Norwegian buildings. BUTLER has a detailed characterization of the Norwegian building sector but does not explicitly capture the interaction between the surrounding energy system. For example, the model assumes a given electricity and district heat price and assumes that the implementation of energy efficiency measures or local PV generation in a building does not influence these prices. Furthermore, using BUTLER alone cannot capture the competition and interaction between end-user flexibility in buildings with other flexibility sources, such as the flexibility available in the hydropower, industry, sport sectors. Nevertheless, by linking BUTLER with IFE-TIMES-Norway, we can capture these dependencies.

The linkage will be designed to analyze how energy solutions in the Norwegian building sector should develop from a socio-economic perspective, and how Norwegian buildings can facilitate cost-efficient decarbonization of the Norwegian energy system. Note that IFE-TIMES-Norway also covers the Norwegian building sector but with a coarser detail level than BUTLER. The linkage between the BUTLER and IFE-TIMES-Norway will, therefore, be used to address what is the necessary detail level of the building sector in energy system models to give an appropriate representation of end-use flexibility in Norway. Furthermore, since BUTLER optimizes from a building perspective, and IFE-TIMES-Norway optimizes from an energy system perspective, FlexBuild will use the two models to analyze whether there is a mismatch on what energy solutions that is cost-optimal from a building developer perspective compared to a central-planner perspective.

The methodology for linking BUTLER and IFE-TIMES-Norway is an ongoing development throughout the project period. For the second year, the focus has been to harmonize demand data, demand profiles, 2018 calibration, heat pump modelling and assumptions regarding water-borne heating and district heating options. These harmonizations are included in the model results of IFE-TIMES-Norway and BUTLER in the sections below. The plan for project year 3 is to establish and demonstrate a linking methodology between the two models. A first plan is to use the demand for electricity and district heat from BUTLER to IFE-TIMES-Norway and to use the corresponding energy prices from IFE-TIMES-Norway to BUTLER. Note that since both models will apply a stochastic modelling of weather-dependent parameters, the linking will capture the interaction between the Norwegian building sector and energy system for that considers different realizations of weather-dependent parameters such as heat demand and solar PV generation.

#### **Linking and harmonization of EMPIRE and IFE-TIMES-Norway**

Since the regional coverage of IFE-TIMES-Norway is limited to the five Norwegian spot price regions, the model does not explicitly capture the interaction with the European power market. This includes how the future Norwegian energy system is influenced by the European power market, and how the Norwegian electricity trade influences the European power market. Since the Norwegian energy system, including the role of end-use flexibility, to a high degree influences with the European power market, these aspects should be covered in the FlexBuild analysis. This is done by linking IFE-TIMES-Norway with EMPIRE, a long-term optimization model of the European power and heat market.

The methodology for linking IFE-TIMES-Norway with EMPIRE is also an ongoing development throughout the model period. For the second project year, the focus has been to align the interpretation of the storyline descriptions, harmonization of technology data, and to establish a linking methodology between the two models. In the TIMES results below, it is

used expected electricity prices for countries outside Norway from EMPIRE to IFE-TIMES-Norway. This linking methodology, is on the other hand, further developed, and there is ongoing activity on a more advanced and bio-directional linking methodology. This involves exchanging a set of European power prices, with weather-dependent realizations of renewable power generation and electricity demand, from EMPIRE to IFE-TIMES-Norway. This requires that consistent modelling of renewable electricity generation and demand through the development of weather-dependent stochastic scenarios. For example, it is necessary to ensure wind power in Norway is correlated with, e.g., the wind power in Sweden and Germany. The next step is to use the corresponding electricity trade with Europe from IFE-TIMES-Norway as an input to EMPIRE. A first full demonstration of this linking methodology, and an understanding of the impact of the linking, will thus be the focus of project year 3.

### **Linking and harmonization of Fansi and IFE-TIMES-Norway**

To address the FlexBuild objectives, it is necessary to capture the interaction between hydropower and end-use flexibility since Norway has extensive flexibility available in the large hydro reservoirs. With five model regions and wide sectoral coverage, IFE-TIMES-Norway has an aggregated representation of the hydropower. To assess the inherent flexibility of Norwegian hydropower, the model FanSi is applied. FanSi is an optimization model for power markets with a detailed representation of the Nordic hydropower system, including cascaded hydro courses with numerous reservoirs and power plants. The motivation by the linkage is to ensure that the FlexBuild analyzing considers the characteristics of Norwegian hydropower in an appropriate manner.

For the second project year, the focus has been to align the hydropower modelling and assumptions in IFE-TIMES-Norway and Fansi. The availability of reservoir and run-of-the-river hydropower plants in IFE-TIMES-Norway is provided by Fansi simulations of weekly hydropower generation for all weather years from 2000 to 2015. This data has also been used as a basis to generate the stochastic scenarios, that is e.g., used to represent the weather-dependent hydropower generation in IFE-TIMES-Norway. For the Fansi results presented below, installed generation, transmission capacity, and electricity demand from IFE-TIMES-Norway are inputs to FanSi. In this way, we can address how various developments of the future energy system influence the operation of the Norwegian hydropower. An ambitious way forward is to develop a bidirectional linking strategy with a clearly defined convergence criterion between the two models. This linkage is necessary to ensure that the investments IFE-TIMES-Norway considers the detailed characteristics of the Norwegian hydropower system.

## **2.2 Quantification of storylines in FlexBuild models**

The storylines are quantified in the various FlexBuild models to address what is the role of end-use flexibility for different low-carbon transition pathways towards 2050.

A major focus of year two, related to development of annual demand projections and demand profiles of the Norwegian building stock for the four storylines. This has been executed by the PROFET load profile tool that is described in more detail in the next section.

The demand data from PROFET provides input to BUTLER and IFE-TIMES-Norway. Furthermore, the energy system model, IFE-TIMES-Norway, quantifies the storylines by four set of different model assumptions on technology availability, technology learning and demand projections. Thereafter, the corresponding storyline-specific model results of IFE-TIMES-Norway, provides input to the European power market model, EMPIRE, and the Norwegian power market model, EMPS.

Table 1. IFE-TIMES-Norway model assumption for the Petroleum, Energy, Nature and Climate Panic nation storylines.

Model assumption	Petroleum nation	Energy nation	Nature nation	Climate panic
<b>Carbon capture &amp; storage</b>	From 2030	No	From 2030	No
<b>Blue hydrogen production</b>	From 2030	No	No	No
<b>Technology learning: Green hydrogen</b>	Low	High	Moderate	Low to 2030 High in 2050
<b>Technology learning: PV and stationary batteries</b>	Low	High	Moderate	Low in 2030 High in 2050
<b>New wind power potential</b>	Moderate	High	No new capacity	Mod. to 2030 High in 2050
<b>Technology learning: Wind power</b>	Moderate	High	Low	Moderate
<b>National transmission grid expansion</b>	If profitable	If profitable	No	If profitable
<b>International electricity grid expansion</b>	No	If profitable	If profitable	No
<b>Road Transport demand projections</b>	High	Moderate	Low	High to 2030 Low in 2050
<b>Industry activity projections</b>	Basis prognosis	Basis prognosis without oil and gas	Status quo without oil and gas	Status quo without oil and gas

### 2.3 Energy demand models: PROFet – FLEXor – BUTLER

This modelling capacity is under development in a stepwise process, benefitting also from work done outside of the Flexbuild project. The first step is to represent the typical energy demand of the building stock, without considering flexibility; this is done by the PROFet model (PROFile estimator). The second step is to consider the operational flexibility of energy demand, thus deviating from the typical profiles; this is done by the FLEXor model (FLEXible operation). The third step, and the final goal in Flexbuild, is to include also a robust investment choice, based on several stochastic scenarios of the operational phase; this is done by the BUTLER model (BUilding's opTimal Energy design and opeRation).

The work on building modelling at SINTEF Community in the second year (2020/2021) has focused mainly on PROFet and include detailed modelling of the development of the Norwegian building stock for each of the four storylines finding the buildings demand for space heating, domestic hot water and electric specific demand. Secondly, the building stock is matched with heating technologies, calculating the energy use of electricity, district heating and wood which is calibrated against the national energy statistics from Statistics Norway (SSB). This is explained in Chapter 3. The single building case study in Chapter 8 shows the potential of analysing flexibility with the FLEXor model, while the development of BUTLER with optimal investment choice was not pursued this year.

Further, the PROFet load profile tool is updated with new measurements from the trEASURE database and is expanded to including a third energy efficiency level. The PROFet tool now provides load profiles for three energy demands: space heating, domestic hot water and electric specific demand, for three energy efficiency levels: regular, efficient and very energy efficient. The modelling expansion is explained in Appendix B: PROFet.

#### Load profiles from PROFet

PROFet is a load profile generator, which can predict hourly load profiles for both thermal loads (space heating (SH), heating of domestic hot water (DHW)) and electric loads, based solely on outdoor temperatures and building area. The temperature dependency has been extracted from a database, trEASURE, of monitored buildings, mostly connected to district heating. trEASURE is a measurement database where monitored energy data with hourly resolution from different buildings in Norway has been collected, including the data from the 100 buildings used for the previous development of PROFet. trEASURE has now been

extended to include more than 300 entries representing ca. 2.4 million m<sup>2</sup> of floor area, subdivided into 11 building categories, both residential and (mostly) non-residential buildings.

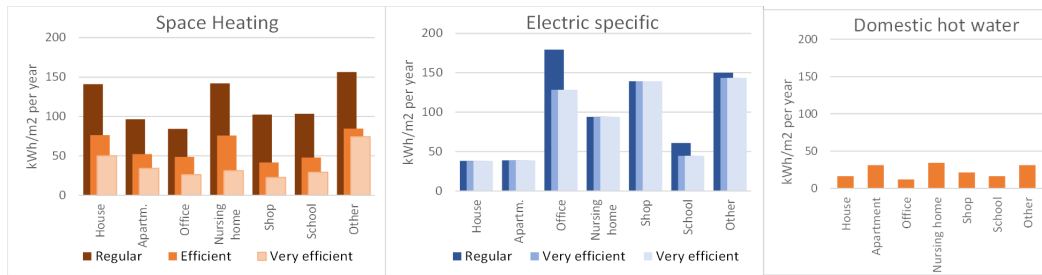

Figure 10. Typical annual space heating demand, electric specific demand and domestic hot water demand, separated on regular, efficient and very efficient building envelope for seven different building types (kWh/m<sup>2</sup>/yr). Average numbers from the trEASURE database.

PROFet estimates the typical load profile of an area based solely on building area input and outdoor temperatures. The model creates a specific load profile based on the typical energy signature curves (ESC) for buildings in different groups (building categories and energy efficiency levels). An example of results from PROFet is shown in Figure 11, which shows Aggregated load profile of office buildings during one week in winter with different energy efficiency levels, plotted against the outdoor temperature.

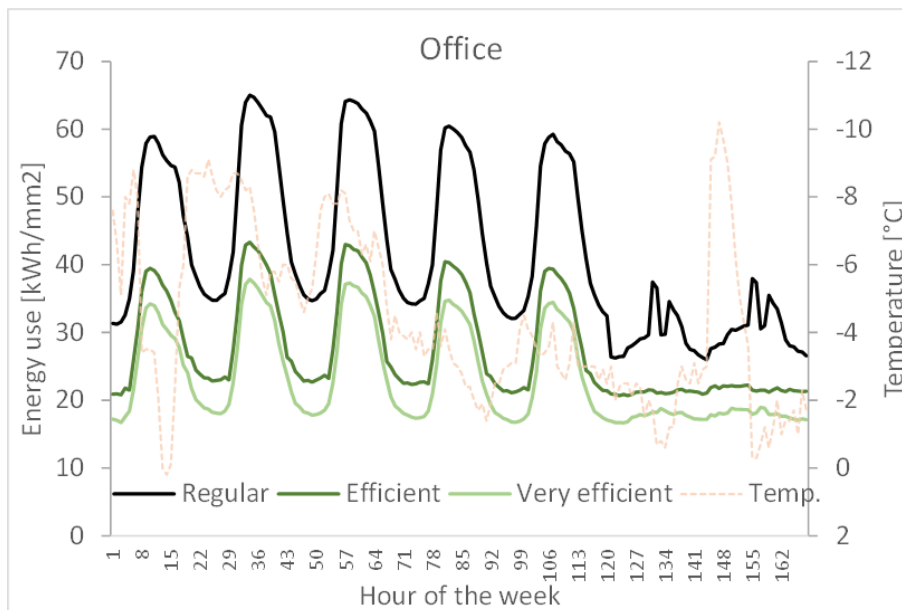

Figure 11. Aggregate load profile of office buildings during one week in winter with different energy efficiency levels.

Electricity used in buildings can be split into several end-uses and technologies, where some of these end-uses have a flexibility potential. This is illustrated in Figure 12.

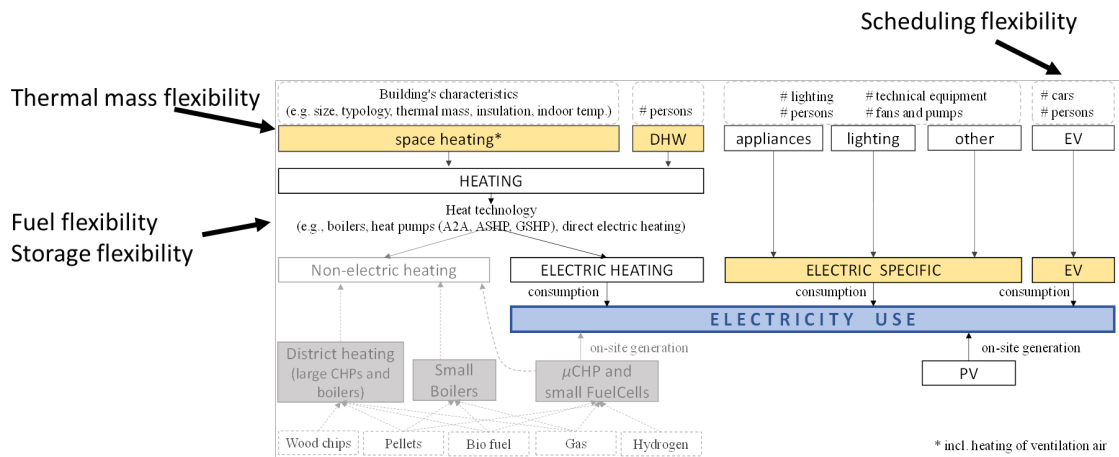

Figure 12. A general structure of the electricity load of buildings, including technologies (EVs, PV, CHP and electric heating) at end-user level that may influence the building's electricity load, with indications of which end-uses which have a flexibility potential (based on Lindberg et al., 2019)<sup>2</sup>.

PROFet has been used to calculate energy demand load profiles in FLEXBUILD. The table below gives an overview of the available building categories in PROFet and the corresponding building categories used in FLEXBUILD. The building category "Other" represent the entire building mass, which is not considered to be houses, apartments, offices, nursing homes, shops or schools. "Other" includes buildings in the categories kindergarten, hotels, universities, culture and sports, hospitals, and light industry. The load profiles for "Other" has been created using a weighted average (based on building area). "Light industry" is not included in the weighting as this is not a building category within PROFet, but the total area of Other will include that of "Light industry".

Table 2. Overview of profet building categories and corresponding building categories used in FLEXBUILD.

Table 3. Composition of the building category "Other"

Building categories	
PROfet	FLEXBUILD
House	House
Apartment	Apartment
Office	Office
Nursing_home	Nursing home
Shop	Shop
School	School
Kindergarten	Other
Hotel	
University	
Culture_Sport	
Hospital	
Other	

Definition of "Other"	
Building category	Share
Office	-
Shop	-
Hotel	31 %
Kindergarten	10 %
School	-
University	13 %
Culture_Sport	24 %
Nursing_home	-
Hospital	22 %

## 2.4 Potential for small-scale and large-scale district heating

To estimate the flexibility potential of the power system and heating system in Norway, it is necessary to have an overview of the status and the maximum potential for district heating.

<sup>2</sup> K.B. Lindberg, S. Bakker, I. Sartori (2019). Modelling electric and heat load profiles of non-residential buildings for use in long-term aggregate load forecasts. *Utilities Policy*, 58, pp.63-88

### FlexBuild regions

The Norwegian building stock and energy system is regional divided into the current five spot price regions of Norway, NO1 to NO5. Further, to consider the different possibilities for district heating within these regions, we have split the regions further into rural and urban areas.

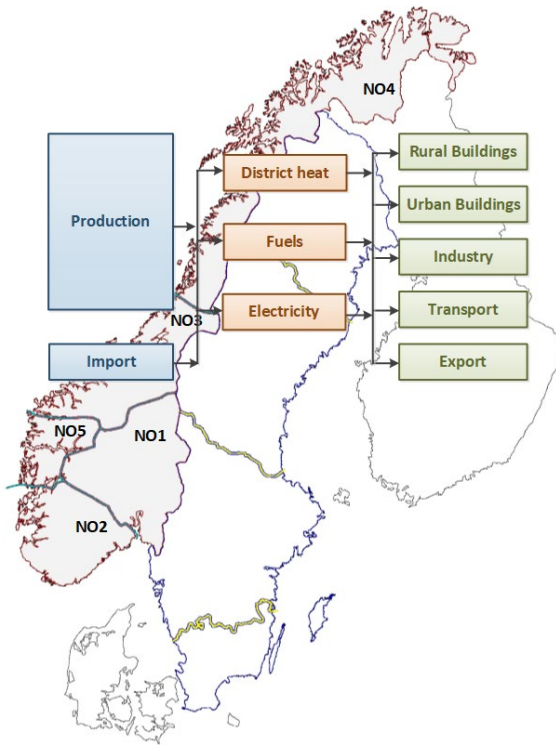

Figure 13. Illustration of FlexBuild regions

### Current status

Information on a district heat plant level is available at [fjernkontrollen.no](http://fjernkontrollen.no), where most of the district heating companies report data. Most of district heating is produced in spot price region of NO1 (Oslo region), with 3.3 TWh in 2019, whereas NO3 is the region with the second largest production.

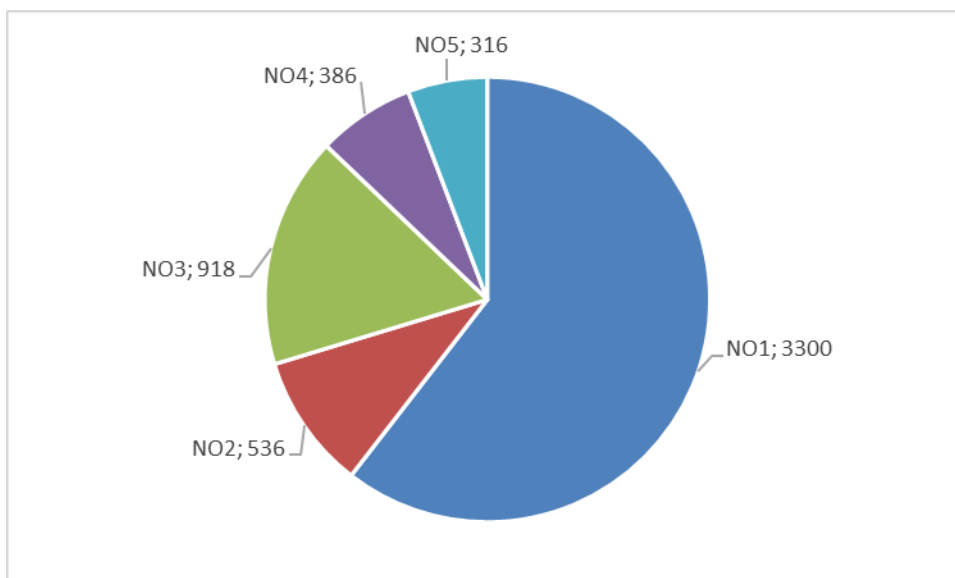

Figure 14. District heating production per elspot area in 2019 (fjernkontrollen.no), GWh/year

Only one site produces more than 1 TWh/year (Oslo) and two more produce more than 300 GWh/year (Trondheim and Bergen). The number of plants delivering 100–300 GWh/year was 8 in 2019 (Hamar, Tromsø, Kristiansand, Ålesund, Lillestrøm, Fornebu, Forus, Drammen). In total 11 plants produce 3.8 TWh/year. If it is assumed that it is only smaller plants that do not report to fjernkontrollen.no, the production from plants with an annual production less than 100 GWh/year can be estimated to 2.8 TWh produced at 90–100 plants. Based on this, the definition of large and small/local district heating systems is that large grids produce more than 100 GWh and small/local district heating systems produce < 100 GWh/year.

### Urban and rural areas

One way of estimating a maximum potential for district heating is to base it on an assumption that all commercial buildings and dwellings in areas with high enough density can be connected to a district heating system (large or small/local). Statistics Norway publish data on people living in rural areas (densely populated areas), defined as “at least 200 people live in an area of houses with less than 50 m apart”. With this definition 18% of people in Norway live in areas that cannot be connected to local or large district heating systems. The share differs in the five Norwegian el price regions, see Table 4.

It could be argued that the share of commercial buildings and multi-family houses is higher in densely populated areas than in sparsely populated areas, than the population figures give as a result, but there are also other barriers that is not considered, so all-in-all it is considered as a reasonable assumption.

Table 4. Population in densely and sparsely populated areas. (SSB)

	Electricity price area	Densely populated area	Sparsely populated area
East	NO1	86 %	14 %
South	NO2	84 %	16 %
Middle	NO3	74 %	26 %
North	NO4	72 %	28 %
West	NO5	80 %	20 %
<b>Norway</b>		<b>82 %</b>	<b>18 %</b>

Another assumption made, based on information from major Norwegian district heating companies, is that it is unlikely for single-family houses, regardless of being situated in urban or rural areas, to be connected to a district heating system as the distances between them often is large, which increases the cost of district heating. This is a simplification and is not true in



all cases, but as a model assumption it is justified since it often is not profitable to connect dwellings to a district heating grid. On the other hand, it is assumed that all multifamily houses within densely populated areas are possible to connect to a heat grid.

### Waterborne heating

Buildings with a waterborne heating system can be connected to a district heating grid at lower costs than buildings with point source heating. Therefore, it is assumed that only the existing buildings with central heating can be connected, since it is an assumption in the FlexBuild project that investments in waterborne heating is not to be included in the model optimisations.

Based on the work conducted in the calibration (see chapter 3), and on statistics from the energy labels system (Bøhn, 2020) and SSB report (Bøeng, Halvorsen, & Larsen, 2014a), FlexBuild's assumption is that the share of waterborne heating in existing and new commercial buildings is 58% and 90%, respectively. In multifamily houses, the share is estimated to 38% in existing and 88% of new houses. In single-family houses the share of waterborne heating is 12% in both existing and new dwellings, but since it is assumed that they cannot be connected to a district heating grid, the share is 0%. The national numbers are shown in Figure 15, and although not shown here, the numbers are also available on regional level.

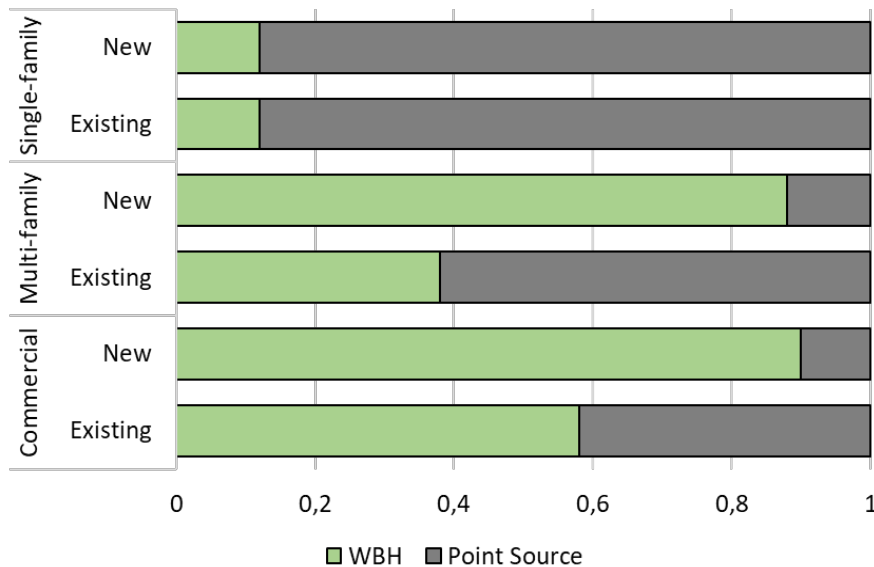

Figure 15. Current share of waterborne heating (WBH) and point-source heating in buildings.

### Maximum potential for small scale and large-scale district heating

Definition of large and small district heating systems is based on that “large” systems are applicable in cities and “small/local” systems otherwise. The estimate of people living in “cities” is not well founded but based on different statistics and knowledge of district heating grids of today. Statistics used for the calculations are statistics of inhabitants in the centre of cities divided by total inhabitants of the region, see resulting share in Figure 16.

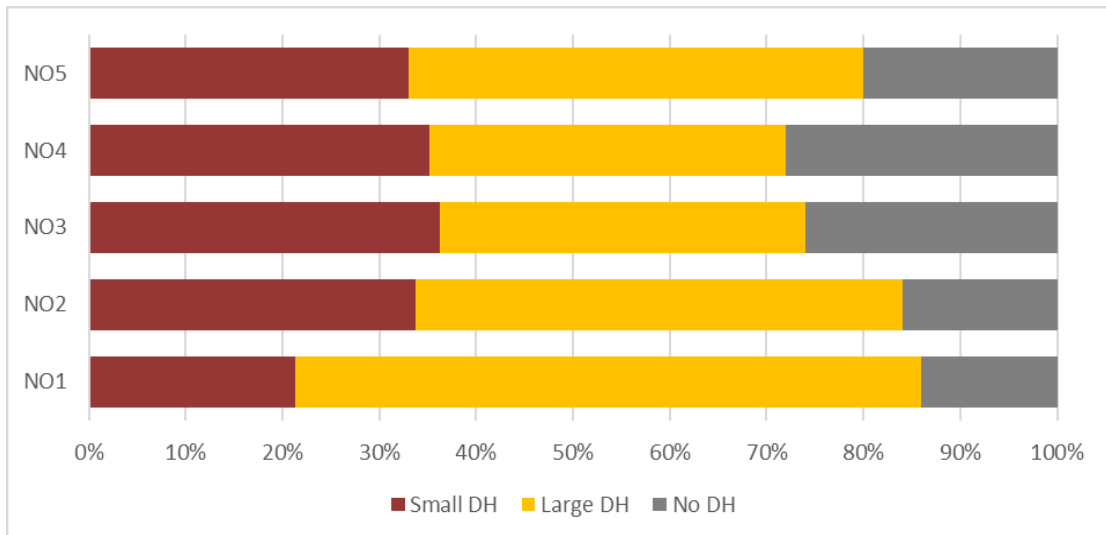

Figure 16. Maximum potential for *small*, *large* and *no* district heating systems per region. Share of buildings.

The maximum share of connections to large or local district heating grids per type of dwelling and commercial building is presented in Table 5. In this table, “buildings” refer to both multi-family houses and commercial buildings.

Table 5. Share of the building stock with waterborne heating that can be connected to large and small (local) district heating grids. Percent per region.

	Region	Single-family houses	Buildings with point-source heating	Buildings with waterborne heating in large scale systems	Buildings with waterborne heating in small scale systems
<b>East</b>	NO1	0%	0%	56 %	30 %
<b>South</b>	NO2	0%	0%	42 %	42 %
<b>Middle</b>	NO3	0%	0%	28 %	46 %
<b>North</b>	NO4	0%	0%	27 %	46 %
<b>West</b>	NO5	0%	0%	38 %	42 %
<b>Norway</b>		<b>0%</b>	<b>0%</b>	<b>44 %</b>	<b>38 %</b>

With these possible maximum shares for connection in urban and rural areas, (for connection to local or large district heating grids, respectively), combined with the heat demand of these buildings based on the Stock-model and PROFet (see chapter 3.2), the total upper potential is calculated to 10-11 TWh in 2030–2050.

Table 6. Maximum potential of use of large and small scale (local) district heating in buildings 2030 (GWh/year).

	Region	Single-family houses	Buildings with point source heating	Multi-family houses with waterborne heating <i>Large</i>	Multi-family houses with waterborne heating <i>Small</i>	Commercial with waterborne heating <i>Large</i>	Commercial with waterborne heating <i>Small</i>
<b>East</b>	NO1	0	0	660	360	2 150	1 170
<b>South</b>	NO2	0	0	280	280	1 040	1 030
<b>Midle</b>	NO3	0	0	110	180	410	670
<b>North</b>	NO4	0	0	60	110	280	480
<b>West</b>	NO5	0	0	100	110	400	450
<b>Norway</b>		<b>0</b>	<b>0</b>	<b>1 210</b>	<b>1 040</b>	<b>4 270</b>	<b>3 800</b>

In Figure 17, the use of district heating in 2019 is compared to the maximum potential in 2030 based on the above calculations. The potential in industry, construction and others assumes that its increase is as in commercial buildings. In total the potential in 2030 will be 13 TWh compared to the use of district heating in 2019 of almost 6 TWh. In Figure 18, the calculated maximum potential in 2030 of large- and small-scale district heating per elspot region is presented.

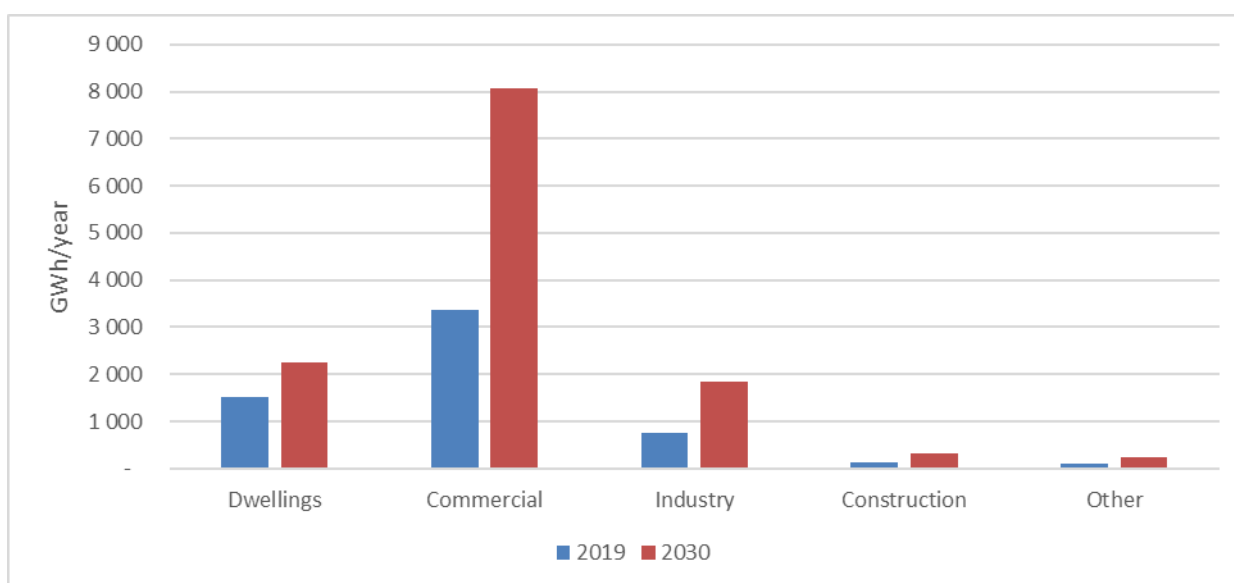

Figure 17. Current use of district heating in 2019 and calculated maximum potential in 2030 per end-use sector (GWh/year). Norway total.

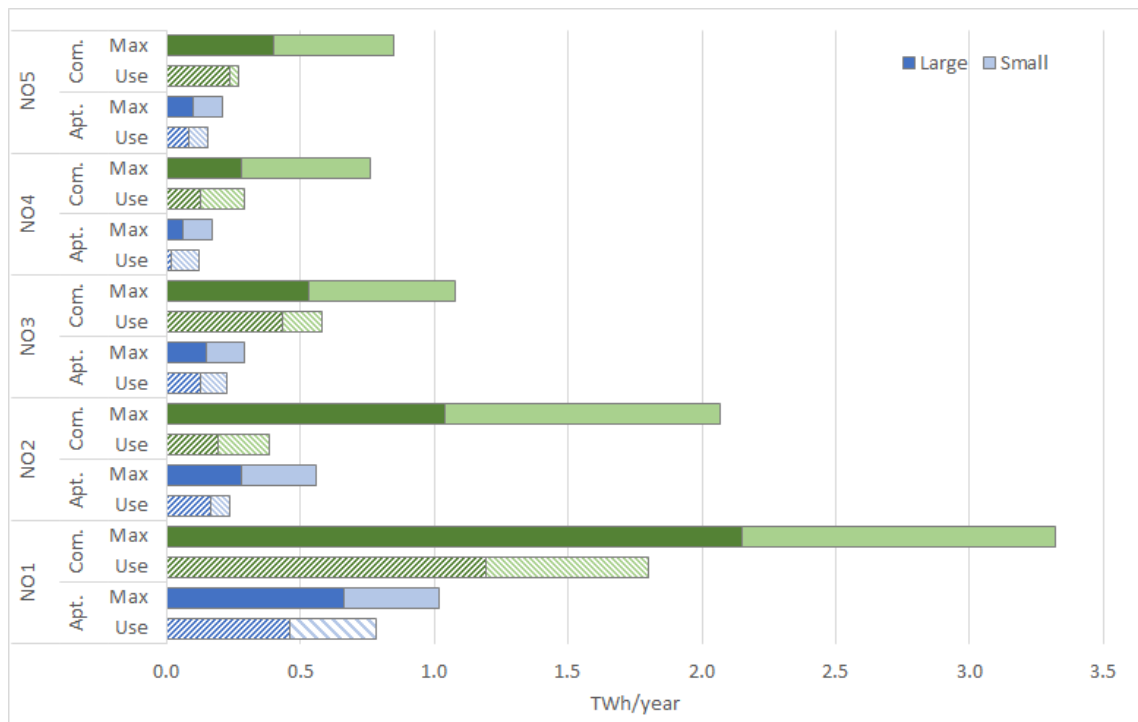

Figure 18. Calculated maximum potential in 2030 of large- and small-scale district heating (TWh/year). Potential per region.

## 2.5 Stochastic model input

By using stochastic programming, FlexBuild can provide investment decisions that explicitly consider different operational situations that can occur due to the weather-dependent model parameters. This is because a model that does not take this uncertainty into account can give misleading insights regarding future investment needs and the value of end-use flexibility.

Project year two has established a consistent data basis that describes the variable and uncertain characteristics of renewable electricity generation, temperature dependent heat demand. Data for wind power and PV generation is derived by modifying simulated hourly satellite-based solar- and wind-power generation data, using historical generation data. Further, data for hydropower generation is provided by EMPS and data on temperature dependent heat demand in buildings is provided from PROFet.

Further, a scenario generation methodology is developed that transforms the dataset into a limited set of discrete scenarios which are used as an input to BUTLER, IFE-TIMES-Norway and EMPS. Since computational effort increases with the number of scenarios used, it is desirable to use as few scenarios as possible, if the scenarios provide decent quality of the corresponding results.

This scenario generation methodology is currently implemented and tested in IFE-TIMES-Norway model. The corresponding stochastic model results will be exchanged with EMPIRE and BUTLER in the linking with these models.

### 3 Building stock evolution and calibration

Nina Holck Sandberg, Synne Lien and Igor Sartori (SINTEF)

The aggregated energy demand in the building stock depends on the building stock size and composition as well as the energy efficiency level of the stock. In the implementation of the Flexbuild storylines, we build on previous research and use various models and methods to simulate the building stock development and its energy use in the period 2020–2050.

#### 3.1 Building stock development: RE-BUILDS

The study includes the whole Norwegian building stock. The building stock is distributed to the residential and service building types. The residential building types include Small house and Apartment block. The service building types include Office, Nursing home, Shop, School and Other (including kindergarten, university, hospital, sports facilities, cultural buildings and light industry buildings), but grouped to one category called "service buildings" in this study.

#### 2020 building stock

The Norwegian building stock in the start year of the analysis, 2020, accounts for a total heated floor area of 386 million m<sup>2</sup> and is distributed to the various building types as shown in Figure 19.

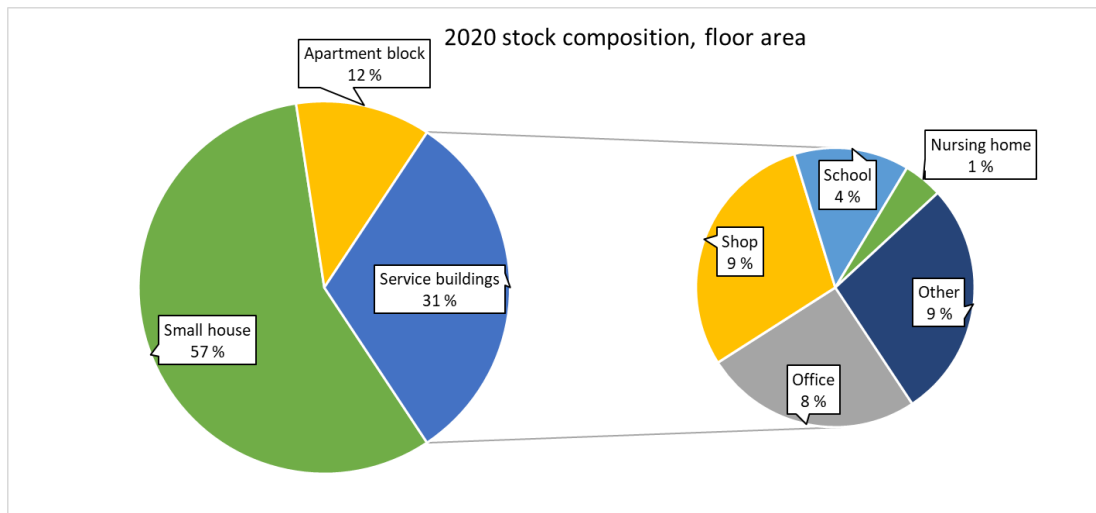

Figure 19. 2020 building stock composition of types (shares of the total heated floor area)

The buildings are further categorized according to the PROFet energy efficiency levels "Regular", "Efficient" and "Very efficient". Buildings constructed before 2010 are assumed to be "Regular" in terms of energy efficiency level. A small share of the stock renovated between 2010 and 2020 is assumed to be energy upgraded to "Efficient", while the remaining renovated floor area from this period is assumed to still being "Regular". The share of renovated floor area being energy upgraded is assumed to be 20%, which is in line with the findings in a comprehensive study of building energy renovation activities and the uptake of nearly zero-energy buildings in the EU (Directorate-General for Energy, 2019). Buildings constructed in the period 2010-2019 are assumed to be "Efficient". In the 2020 building stock, 83% of the floor area is "Regular" and 17% is "Efficient", and distributed to the three building types as shown in Figure 20.

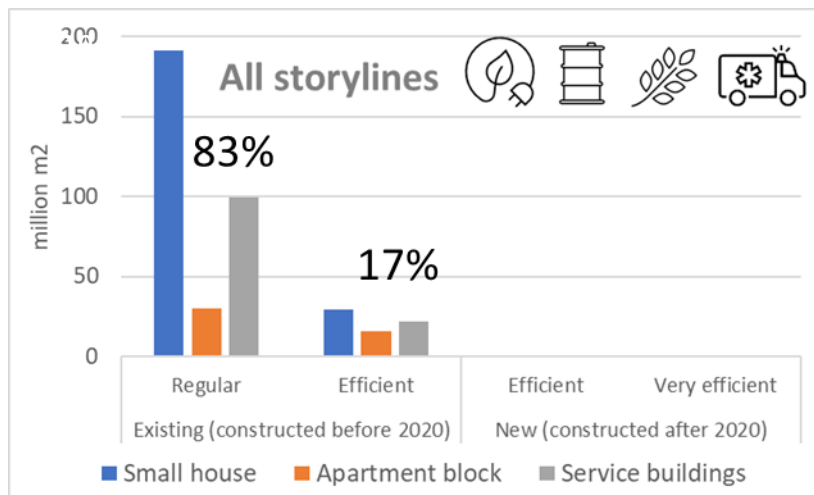

Figure 20. 2020 building stock composition of building types and energy efficiency levels.

### RE-BUILDS 2.0

A modified version of the dynamic building stock model RE-BUILDS 2.0 (Fjellheim et al., 2020; Sandberg et al., 2021) is used to simulate the building stock development from 2020 to 2050 according to an assumed development defined for the input parameters in each of the four storylines. The underlying concept in RE-BUILDS is the changing population size and the population's demand for buildings of various types. The model is slightly different for the residential and service building stocks, as there is more statistics available for the historical development of the dwelling stock (residential buildings) than for the service building stock. However, both parts of the model simulate the stock dynamics and development over time in terms of stock size and composition of types, cohorts, and renovation states. Archetypes are defined based on these three factors.

The total demand for floor area is estimated as the population times the average floor area per person in various building types. For the dwelling stock, the floor area per person is determined by the assumed share of population living in various dwelling types, the number of persons per dwelling in various types and the average floor area per dwelling. For the service building stock, the average floor area per person is assumed to be constant over the period 2020–2050 per building type.

Demolition and renovation functions are applied to simulate the demolition and renovation activity in the system. Renovation may or may not lead to improved energy efficiency. For each year, the estimated new construction is equal to the sum of what needs to be constructed to meet increase in demand plus replacement of demolished buildings.

In the dwelling stock model, we simulate the renovation activity in the system by use of *renovation cycles*  $R_c$ , which corresponds to the average time between two major renovations that can include substantial improvement of the energy-efficiency of the building. The renovation rate is model output.

Furthermore, the RE-BUILDS model is described in detail in Sandberg et al. (2021).

### Implementation of Storylines

The four storylines are implemented in the building stock modelling with differences in energy efficiency levels of new and renovated buildings, differences in assumed renovation rates as well as the average floor area per person in the residential building stock. A decrease in average floor area per person in the residential building stock in some of the storylines results from urbanization and a larger share of the population living in apartments as compared to in small houses.

**The Petroleum nation** serves as the baseline scenario, with a continuation of current trends regarding energy efficiency level of the building stock. Energy efficiency is not pushed, but it is carried out whenever economically profitable. We implement this with a continuation of trends.

**The Energy nation** is mostly modelled in the same way as the Petroleum nation, but as there is a focus on making available energy and power that can be exported, we have assumed that a small increase in the energy upgrading of renovated buildings and passive house new construction after 2030.

In **the Nature nation** storyline, we assume increased shares of Very efficient new construction and Efficient renovation already from 2020. From 2030, we assume all new construction to be Very efficient. In addition, we assume increased renovation rates and more urbanization with higher shares of apartments from 2030.

In **the Climate panic** storyline, we assume the same development as in the Petroleum nation and Energy nation storylines in the period 2020–2030. Thereafter, there are strong changes in most of the parameters, to reflect the situation the nation is in after the events in 2030.

The inputs and assumptions to the building stock modelling of the four storylines are described in detailed in Appendix C: Building stock.

### **Building stock simulation results**

Figure 21–23 show the simulated building stock development from 2020 to 2050, and how it is distributed to new, renovated and unchanged buildings, according to the four storylines. The stock size and distribution to the three categories is equal in the Energy nation and Petroleum nation storylines, as shown in Figure 21. According to these baseline results, the stock is expected to grow by about 17% from 2020 to 2050, mainly due to the expected population growth. The shares of the 2050 stock being constructed or renovated in the period 2020–2050, are 29% and 26%, respectively. The remaining 45% is unchanged, as it is not expected to be demolished as it reaches the end of its lifetime or to have a need for a major renovation. The energy efficiency improvement potential in the stock is limited to the renovated and new floor area. Hence, according to this baseline development, where renovation is carried out only as it is needed to maintain the buildings and measures are not introduced to increase the renovation rate, the 2050 building stock is still dominated by floor area that is in the same condition as today.

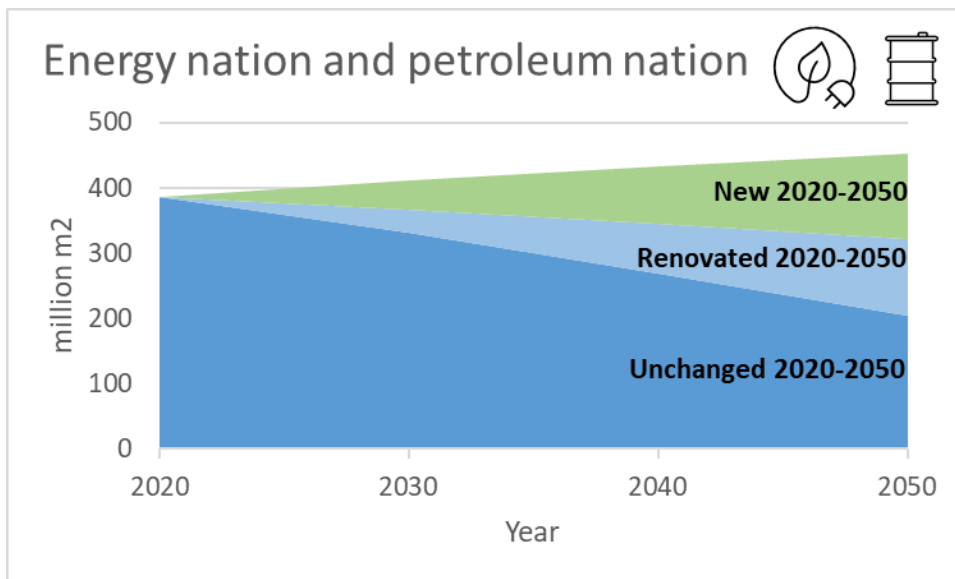

Figure 21. Building stock development 2020-2050, according to the Energy nation and Petroleum nation storylines.

Figure 22 shows the building stock development according to the Nature nation storyline. The overall stock size in 2050 is 2% smaller than in the Energy and Petroleum nation storylines, due to the increased urbanization and higher share of smaller dwellings. Furthermore, the increased renovation rates result in a higher share of the 2050 stock being renovated. However, "Unchanged" is still the largest category in 2050 also in this storyline, with 38% of the total floor area. "Renovated" has increased to 35% and new construction accounts for 27%.

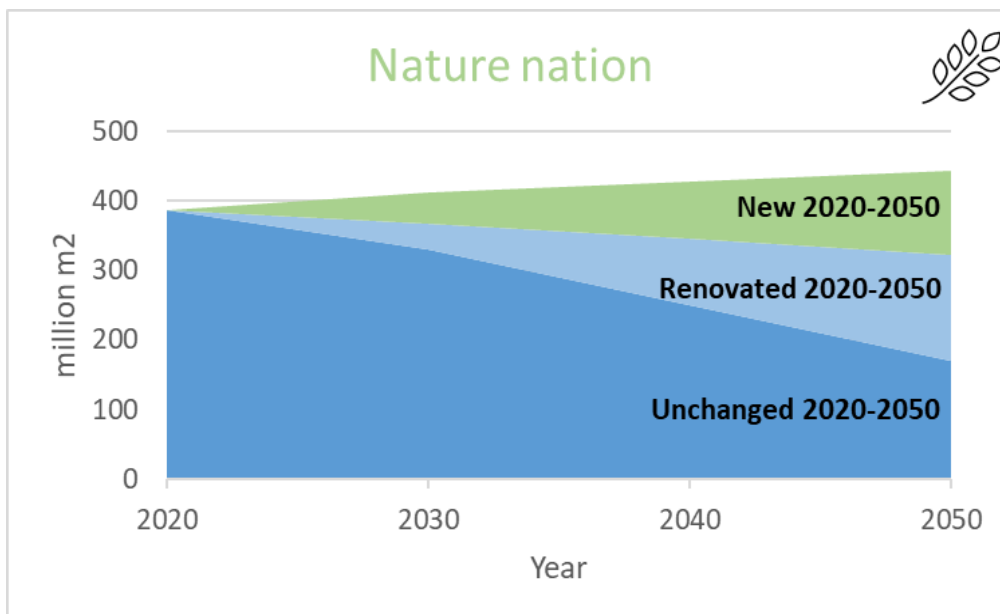

Figure 22. Building stock development 2020-2050, according to the Nature nation storyline.

Figure 23 shows the building stock development according to the Climate panic storyline. The total stock size in 2050 is the same size as in the Nature nation storyline. The strong increase in the renovation rates after 2030 leads to a significantly higher share of the 2050 stock being renovated. This amounts to 42% of the total floor area. 26% is new construction and 32% of the stock is still unchanged and in the same condition as in 2020.



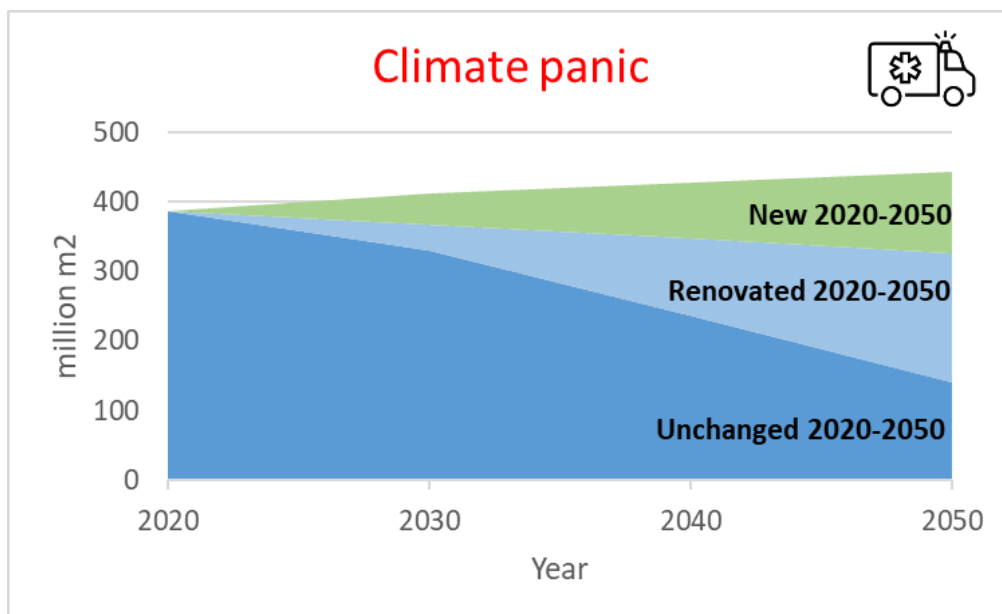

Figure 23. Building stock development 2020-2050, according to the Climate panic storyline.

In total, Figure 21–23 demonstrate that the building stock is a system that changes slowly. Even in the most optimistic storylines, unchanged buildings account for a large share of the stock in 2050. Furthermore, the "renovated" part of the stock may or may not be energy upgraded. Currently, only 20% of the renovated floor area is energy upgraded.

Overall, the residential building stock accounts for about 70% of the total floor area throughout the period 2020-2050, according to all storylines.

#### **Building stock energy efficiency level in 2050**

The development in building stock energy efficiency level towards 2050 depends on the activity level in terms of renovation, construction and demolition, as described above, as well as on the energy efficiency level of new and renovated floor area. Figure 24–27 show how the building stock in 2050 is distributed to existing/new and regular/efficient/very efficient, according to the four storylines.

As previously described, the Petroleum nation and Energy nation storylines have the same development in terms of number of square meters being renovated, constructed and demolished towards 2050. However, the energy efficiency level differs as the Energy nation assumes Very efficient new construction and a somewhat higher share of renovated buildings being energy upgraded after 2030. Figure 25 shows that in the Petroleum nation storyline, which serves as our baseline, 53% of the stock is still existing stock from before 2020 with energy efficiency level Regular, and the remaining 47% is Efficient as it is either renovated and energy upgraded (18%) or new construction (29%). Figure 24 shows that the more energy efficient new construction and renovation in the Energy nation storyline after 2030 results in the overall 2050 shares of the stock being 50%, Regular and existing from before 2020, 30% Efficient (20% existing and 10% new construction) and 20% new construction from after 2030.

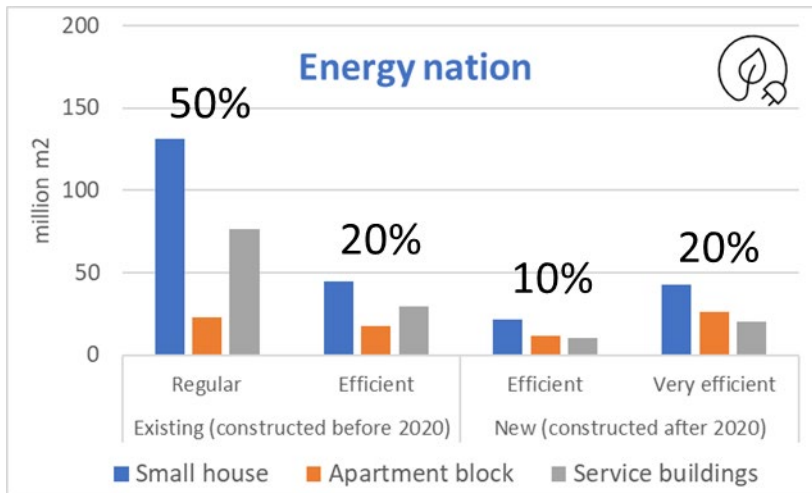

Figure 24. 2050 building stock energy efficiency level, according to the Energy nation storyline.

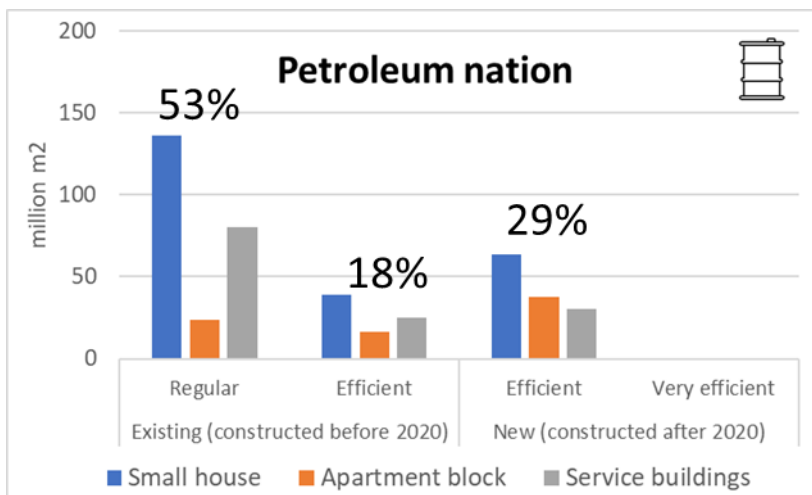

Figure 25. 2050 building stock energy efficiency level, according to the Petroleum nation storyline.

In the Nature nation storyline, half of the new construction is Very efficient already in 2020-2030, as well of all new buildings after 2030. Still, the share of the total floor area in the building stock being Very efficient in 2050 is just 22%, as seen in Figure 26. 35% of the floor area is Efficient, as it is either renovated (28%) or new construction (5%). Existing buildings from before 2020 with the energy efficiency level Regular still makes up the largest share of the stock, with 44% of the total floor area.

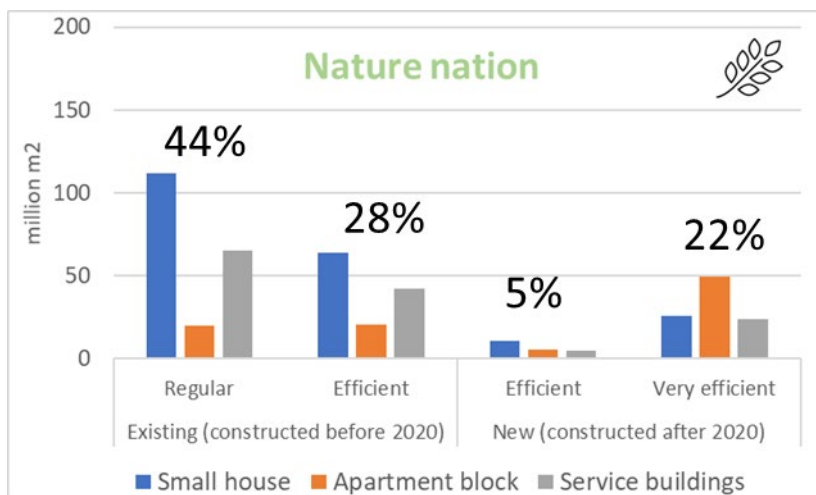

Figure 26. 2050 building stock energy efficiency level, according to the Nature nation storyline

In the Climate panic storyline, all measures are applied to improve the energy efficiency of the stock after 2030. All new construction is Very efficient, renovation rates are increased, and all renovated floor area is energy upgraded to Efficient. As seen in Figure 27, this results in 17% of the stock in 2050 being Very efficient, 54% being Efficient, as it is either renovated and energy upgraded (45%) or new construction (9%). 29% of the floor area is still in buildings that are unchanged from before 2020.

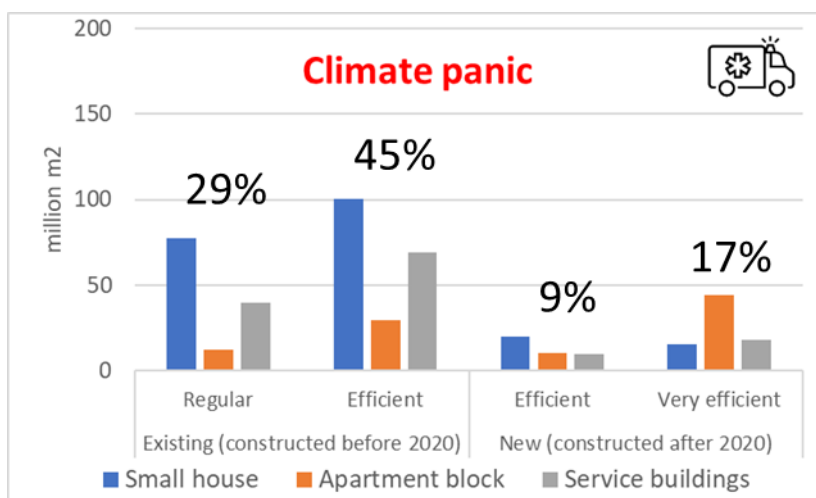

Figure 27. 2050 building stock energy efficiency level, according to the Climate panic storyline.

The results above demonstrate how slowly the building stock develops and how difficult it is to change the overall energy efficiency level of the stock. Due to the long lifetime of buildings and the long period between major renovations, the existing building stock from today will dominate the system and its energy use in decades to come. Still, there is an important potential for improvement and energy savings in the system. The potential energy savings in the different storylines are estimated in Section 0.

The results from the simulated building stock development also demonstrate that even though there is an important potential for improvement in the overall energy efficiency level of the stock, this will not be released if the development continues to follow current trends. Additional strong measures are required, both regarding energy efficiency level of new construction and renovated floor area. Increased renovation rates can also contribute to releasing the potential, but the realism of this must be considered carefully as renovating and energy upgrading buildings is much less cost efficient if the building is not anyway going to be renovated for maintenance reasons.

### 3.2 Energy demand modelling and calibration

To calculate the development of the total energy demand and energy use for the building mass, in each storyline, hourly profiles have been created using the models PROFet and RE-BUILDS previously discussed, as shown schematically in Figure 28.

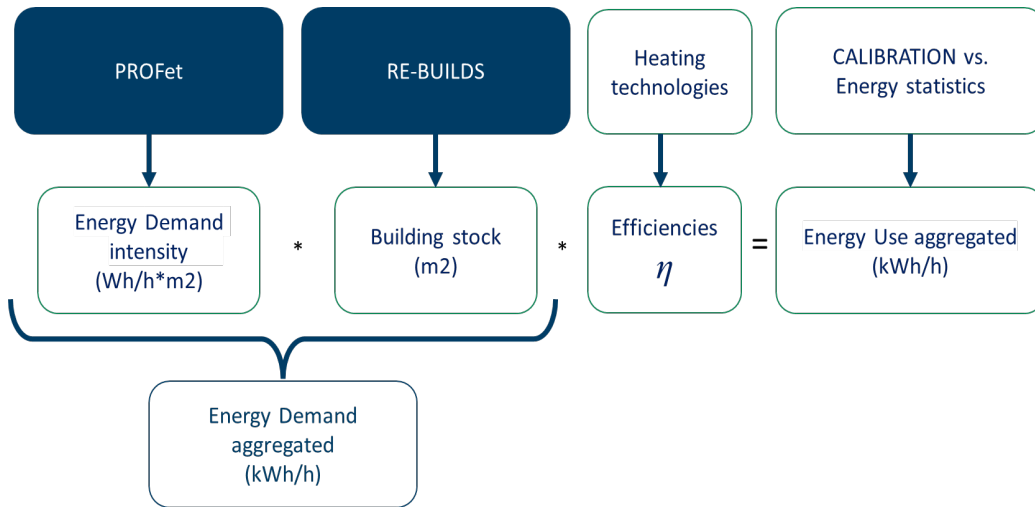

Figure 28. Schematics of the models PROFet and RE-BUILDS are combined to give the aggregated Energy Demand in the building stock, and how the Energy Use is calculated and compared with available statistics, see §1.2 Terminology.

To calibrate the model, the load profile for the building mass in 2020 has been generated by applying a standard weather profile, before comparing the result against national energy use statistic. The chosen weather profile is the NS 3031:2014 Normalized Climate profile for Oslo climate. This is a standardized weather profile which have dimensioning outdoor temperatures (which result in dimensioning loads), but the average temperature over the year will result in normalized annual totals for the heat loads.

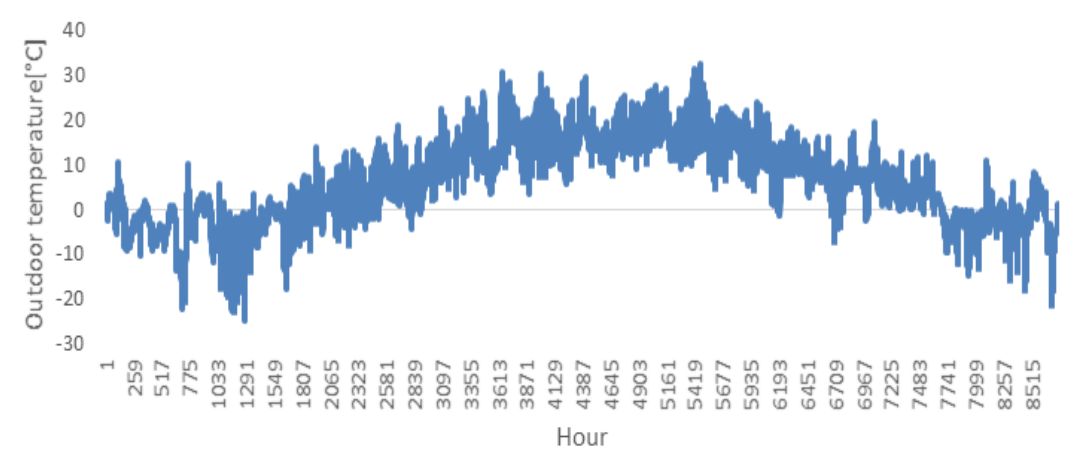

Figure 29. Hourly outdoor temperature over one year from the NS 3031:2014 Normalized Climate profile for Oslo climate.

The load profiles below show typical hourly specific load profiles for an apartment – regular and an office – efficient over one year generated with the standard weather profile. Notice how the energy demand for space heating is a lot higher in the regular apartment compared to the efficient office. The DHW energy load is also higher for the apartment, while the office has a substantial electric load, with peaks caused by cooling demand in the summer.

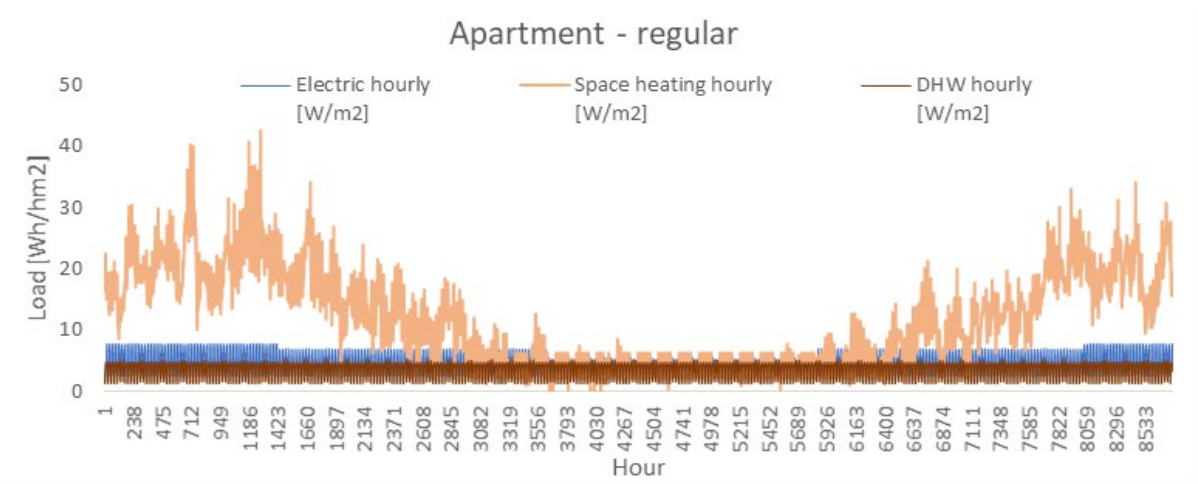

Figure 30. Typical hourly load profile over 1 year space heating, dhw and electric demand for Apartment-Regular.

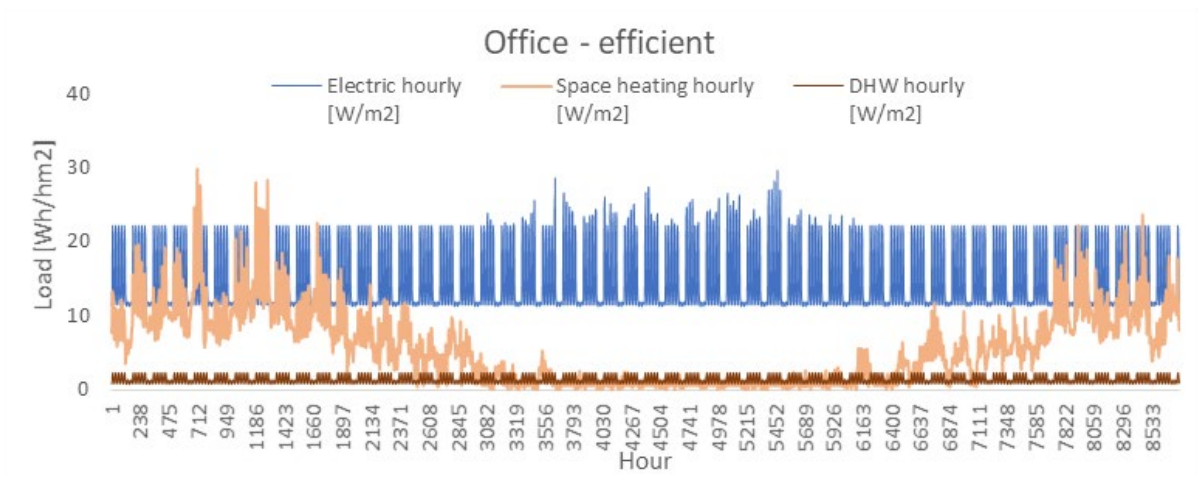

Figure 31. Typical hourly load profile over 1 year space heating, dhw and electric demand for Apartment-Regular.

The figure below summarizes the specific annual total loads for each building category and efficiency generated with the normalized climate profile in PROfet. These loads are defined as gross energy demand as they are based on energy load measurements in buildings with district heating. The energy demand includes losses in the buildings' distribution systems.

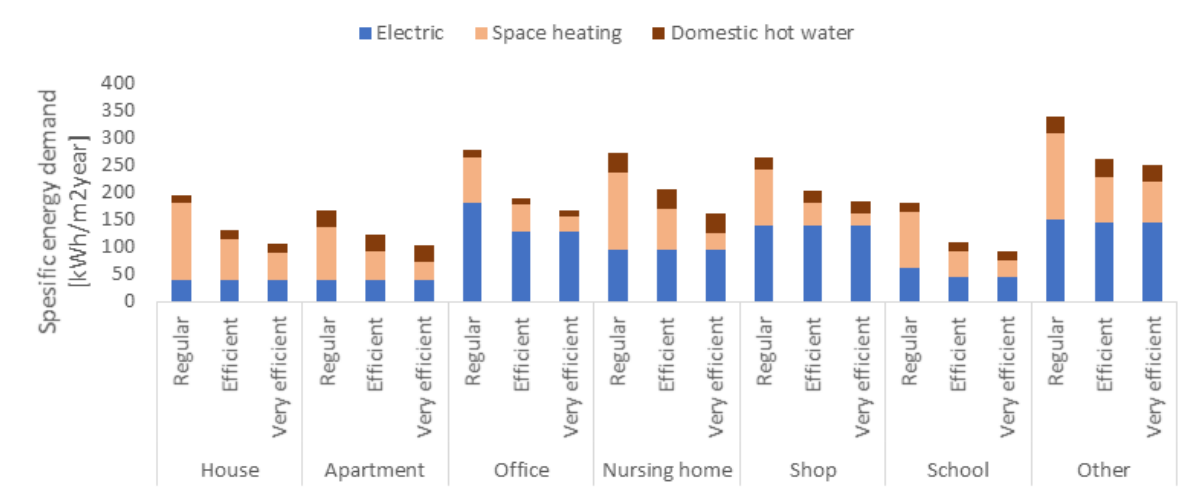

Figure 32. Annual specific energy demand for each building category and efficiency modelled in PROFet for the FLEXBUILD building categories.

Table 7 and show the total calculated energy demand for the building mass in 2020 when it is assumed that the specific energy demand for the building mass is as shown inFigure 32.

Table 7. Total energy demand of the building mass in 2020 modelled with the standard weather profile for Oslo.

	Regular [m <sup>2</sup> ]	Efficient [m <sup>2</sup> ]	Very efficient [m <sup>2</sup> ]	Sum [m <sup>2</sup> ]
<b>Office</b>	26 346 695	4 331 471	0	30 678 166
<b>Nursing home</b>	4 707 883	805 163	0	5 513 046
<b>Shop</b>	30 051 463	5 451 524	0	35 502 987
<b>School</b>	13 331 846	2 890 130	0	16 221 976
<b>Other</b>	28 253 971	5 135 976	0	33 389 947
<b>House</b>	194 569 130	25 575 245	0	220 144 375
<b>Apartment</b>	30 266 993	15 243 219	0	45 510 212
<b>Sum</b>	<b>327 527 981</b>	<b>59 432 728</b>	<b>0</b>	<b>386 960 710</b>

Due to the large area of houses, a large share of the energy demand in buildings are in houses. Most of the energy is used in regular buildings. It is assumed that the area (and energy demand) with the standard "very efficient" is negligible in 2020.

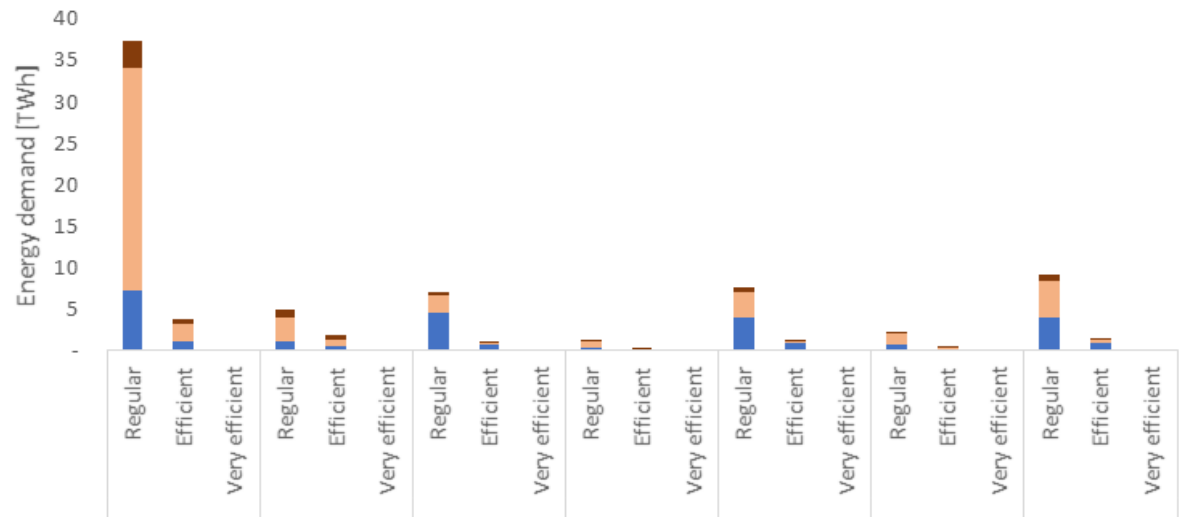

Figure 33. Total energy demand of the building mass in 2020 modelled with the standard weather profile for Oslo.

The model must be controlled and calibrated against statics in the initial year. The total energy use in the residential sector and service sector in Norway is monitored by SSB and is published once a year in the statistics "Energibalansen". Figure 34 shows the development in energy use from different energy carriers in the residential sector and the service sector from 1990 to 2019. The energy use from "Fuels" mostly consists of energy from gasoline, diesel, and jet fuels in the service sector. This energy is likely used in machines and military vehicles and should be ignored when modelling the energy use in buildings.

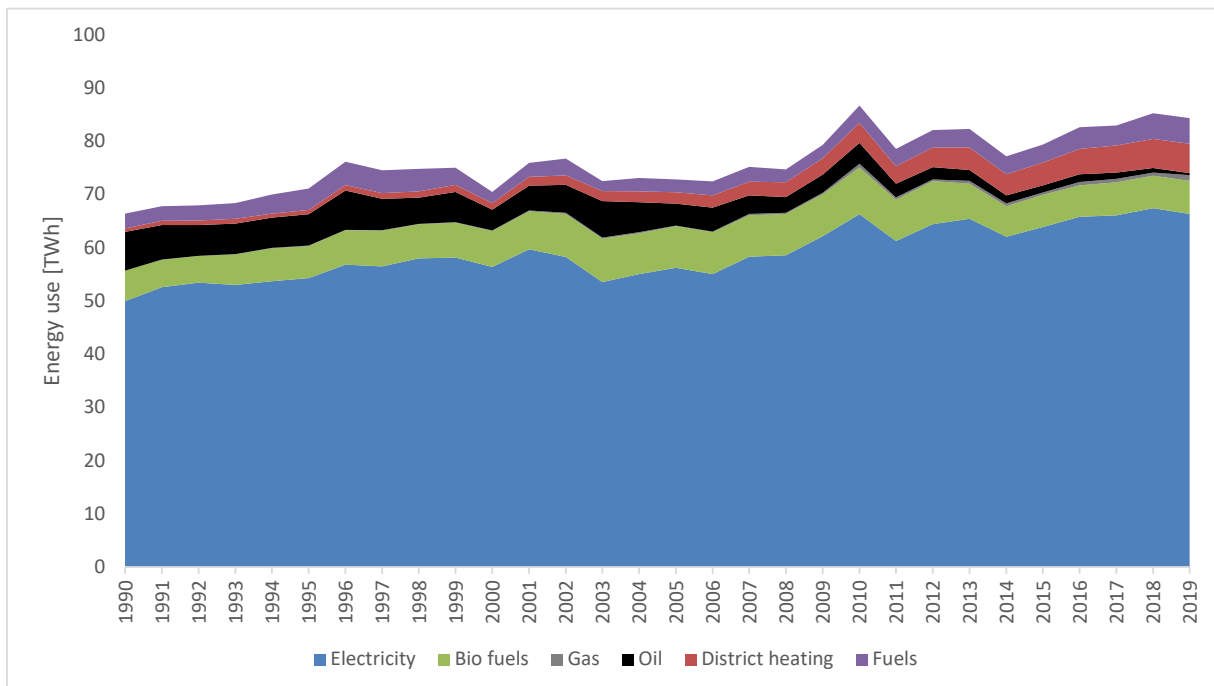

Figure 34. Development of energy use in the service sector and residential sector 1999-2019 (SSB, 2020).

The total energy use has an increasing trend, although it varies from one year to another. The variation in energy use from one year to another is mostly caused by variations in the outdoor temperature. In order to compensate for this, the model should be calibrated against statistics which have been adjusted according to average temperatures. The energy use in buildings is temperature adjusted for heating degree days, as given in the following formula:

$$E_{corr} = E_{measured} \cdot TD_{share} \cdot \frac{HDD_{average}}{HDD_{measured}}$$

To account for difference in climate and population in the in different regions of Norway, the heating degree days used to adjust the statistics have been calculated based on a weighted average as shown in Table 8.

Table 8. Heating degree days, weighted average 2019.

	NO1 Oslo	NO2 Kjevik	NO3 Værnes	NO4 Tromsø	NO5 Bergen	Weighted average
Share of the population living in region (Lien, 2017)	42 %	24 %	14 %	9 %	11 %	-
<i>HDD<sub>average</sub></i>	3626	3236	3967	5136	3037	3651
<i>HDD<sub>measured</sub></i>	3765	3453	3998	4999	3189	3770

As the energy use measurements for 2020 is not available, energy use statistics for 2019 have been used. It is assumed that the energy use of 2020 will be approximately equal to the energy use of 2019. The temperature adjusted energy use of the building stock (service and residential) is shown in Table 9.

Table 9. Temperature adjusted energy use of the service sector and residential buildings in 2019.

	Service		Residential	
	Measured	Corrected	Measured	Corrected
Electricity	25.8	26.2	40.5	41.4
Bio	0.8	0.8	5.5	5.5
Gas	0.5	0.5	0.1	0.1
Oil	0.3	0.3	0.1	0.1
District heating	3.7	3.8	1.5	1.6

### 3.3 Heating technologies and calibration results in 2020

Generally, delivered energy is calculated as follows:

$$Delivered\ energy\ [kWh] = \frac{Specific\ energy\ demand\ \left[\frac{kWh}{m^2}\right] \cdot Building\ area[m^2]}{Efficiency\ of\ technologies}$$

To calibrate the model, there was a need to make assumptions about the efficiencies of the building technologies used in the building mass in 2020. It is assumed that electric demand has an efficiency of 100 %, while heating technologies efficiency differs.



Table 10 show the assumed efficiencies of different heating technologies used in the calibration, and the efficiencies previously used in TIMES and BUTLER.

Table 10. Assumed efficiency of heating technologies in the calibration.

	Efficiency	Efficiency TIMES	Efficiency BUTLER (January)
<b>Electric heater</b>	98 %	100 %	100 %
<b>Electric water heater</b>	98 %	98 %	100 %
<b>Electric boiler</b>	86 %	98 %	98 %
<b>Solar collector</b>	100 %	100 %	
<b>Heat pump air-source</b>	190 % / 171 %	254 %	254 %
<b>Heat pump ground-source</b>	208 % / 187 %	317 %	317 %
<b>Pellets boiler</b>	72 %	81 %	91 %
<b>Oil boiler</b>	72 %	81 %	
<b>LPG boiler</b>	77 %	81 %	
<b>District heating</b>	99 %	99 %	90 %

To obtain information on the use of various heating technologies, statistics on heating technologies have been extracted from the Norwegian Energy Label database system. In Norway, there has been a requirement since 2010 that the energy efficiency of all buildings that are to be sold/rented out, as well as all commercial buildings with an area over 1000 m<sup>2</sup> must be labelled. When energy labelling apartments or detached houses, the owner can create the label themselves through registration in the Energy Labelling system. New apartment blocks and service buildings must be labelled by experts using energy simulation tools such as simian or IDA ICE (Olje- og energidepartementet, 2009). The energy labels are registered in a database and contain information about, among other things, the size of the buildings, age, estimated energy use and which heating technologies are used to cover the buildings' energy needs. The energy label database therefore provides a lot of information about which heating technologies are used in different buildings. Energy labels from houses, apartments as well as service buildings from the period January 2010 – September 2020 were extracted from the energy label database (Bøhn, 2020) in order to make an assumption about which heating technologies are used in different building groups.

Based on the age of the labels in the database and their heating demand, and heating technologies used to cover the demand, the share of heating demand for houses, apartments and service buildings covered by each heating technology was calculated. The heating technology shares were then adjusted according to the following assumptions:

- It is assumed that 12 % of single family houses have waterborne heating distribution systems based on (Bøeng, Halvorsen, & Larsen, 2014b).
- It is assumed that 28 % of regular apartments and 72 % of efficient apartments have waterborne distribution systems based on (Bøeng et al., 2014b) and statistics from the energy labels.
- The share of service buildings with waterborne distribution systems was calculated as a weighted average for the "regular" and "efficient" based on assumptions from (Multiconsult AS & Analyse & Strategi AS, 2012).
- No houses are connected to district heating.
- Wood stoves are only used in houses (never in apartments or service buildings).
- All bioenergy used in households are used in houses (wood stoves).
- All bioenergy used in the service sector is used in pellets boilers.
- Due to the ban on the use of mineral oil for heating buildings, there are no oil boilers or LPG boilers/burners in use in 2020.
- All service buildings have the same distribution of heating technologies.

The resulting share of heating demand being covered by different heating technologies in houses, apartments and service buildings are shown in Figure 35, Figure 36 and Figure 37.

For detached houses, it is assumed that direct electricity is frequently used – about 70% – for heating rooms and ventilation air in 2020. Direct electricity includes both panel heaters, electric boilers and other direct electrical technologies. In addition, there is widespread use of heat pumps. Other heating technologies are used to a lesser extent. In apartment blocks, the use of district heating is more widespread, and district heating dominates in newer apartment blocks, as the main technology for heating. In older apartment blocks, direct electricity is more widespread.

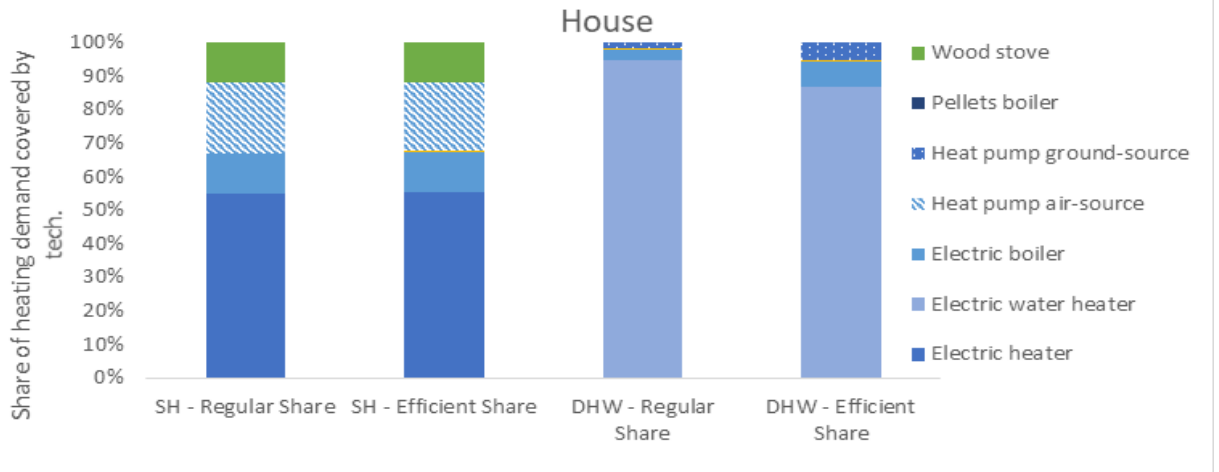

Figure 35. Share of energy demand for space heating and domestic hot water heating being covered by different heating technologies in single family houses in 2020.

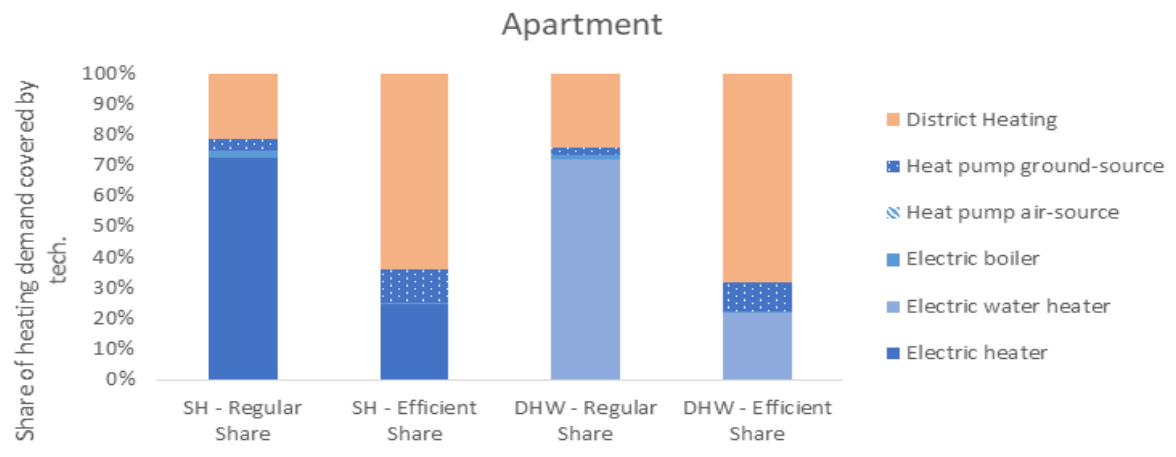

Figure 36. Share of energy demand for space heating and domestic hot water heating being covered by different heating technologies in apartments in 2020.

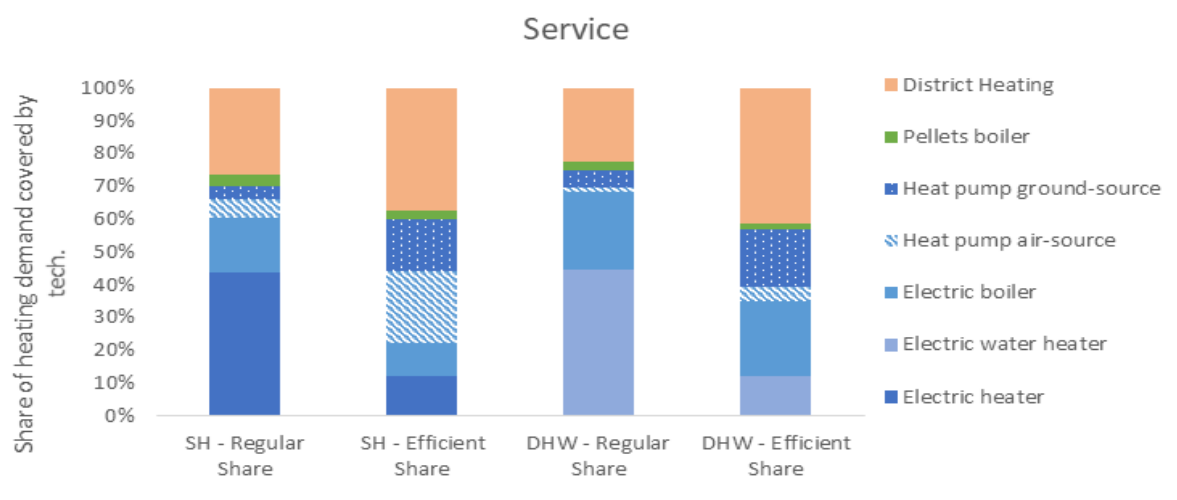

Figure 37. Share of energy demand for space heating and domestic hot water heating being covered by different heating technologies in service buildings 2020.

Combining the assumptions of heating technologies and the total energy demand in 2020 from Table 7 gives the total annual energy use for the model in 2020. Figure 38 shows that there is a good match between the modelled energy use and the measured (temperature adjusted) energy use in 2019 from SSB.

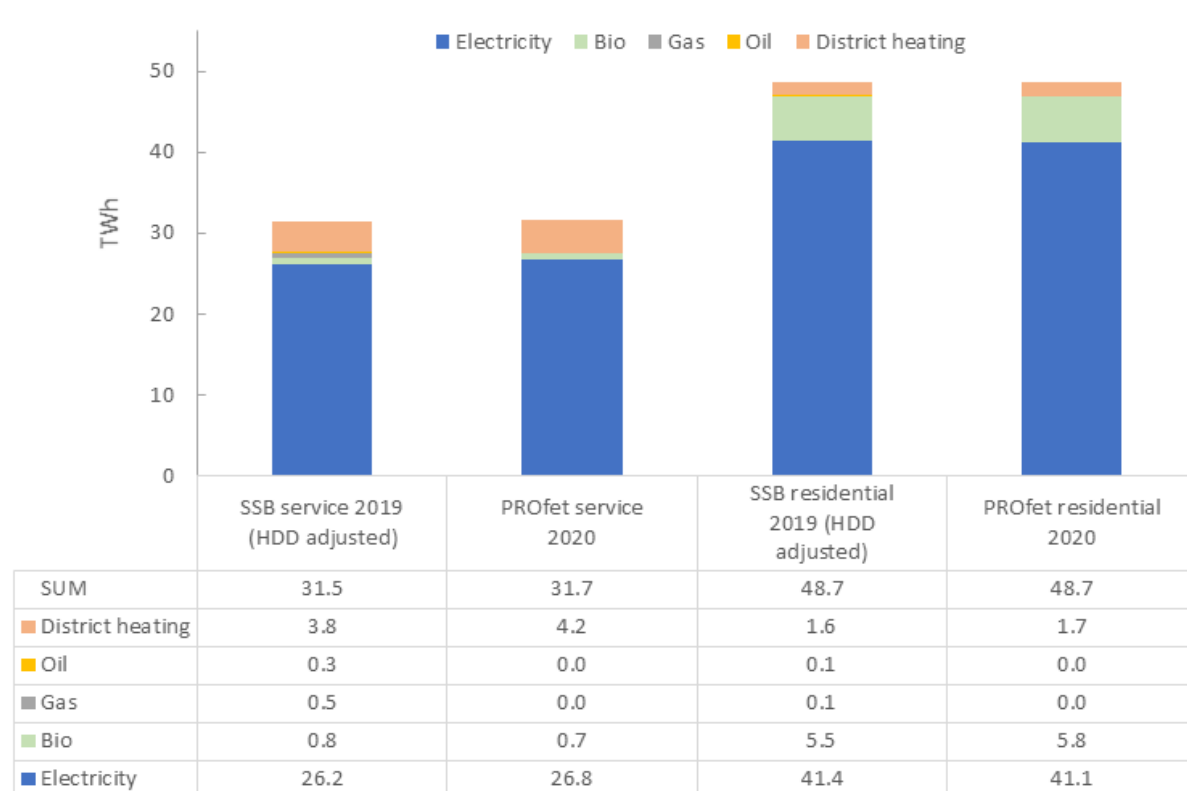

Figure 38. Comparison between modelled energy use in 2020 and measured (temperature adjusted) energy use in 2019 from SSB.

### 3.4 Storyline modelling

Based on the development of building area, the energy demand of each storyline has been calculated for 2030 and 2050 with the energy NS 3031:2014 Weather profile as shown in Figure 39. The development in total energy demand shows smaller changes here compared to other models (NVE, LEAP, Tabula). This is likely due to the fact that a large share of the rehabilitation of regular buildings does not decrease the energy demand of the buildings enough to move the buildings into a more energy efficient category.

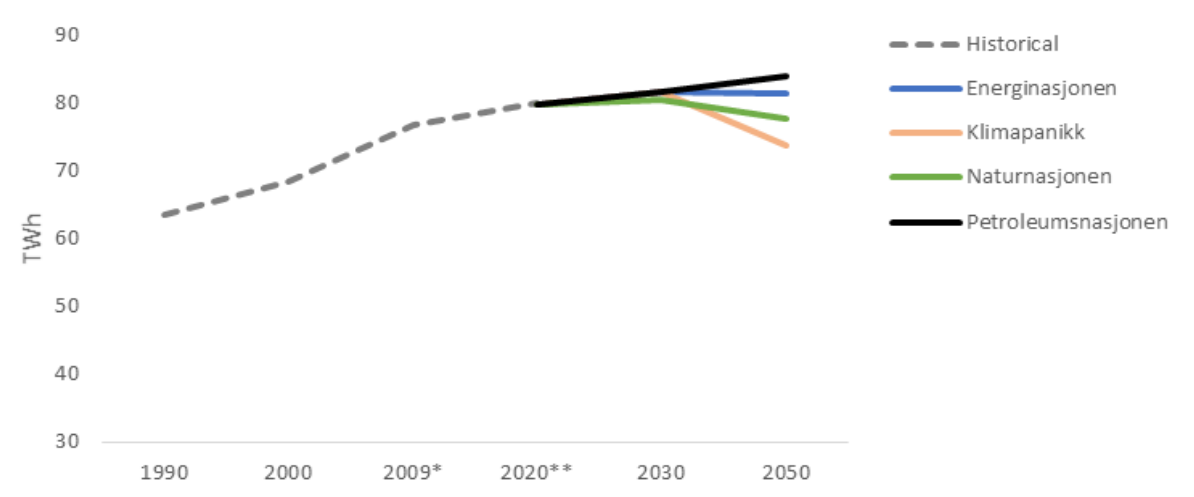

Figure 39. Development of energy demand in each storyline using the energy NS 3031:2014 weather profile.

As input to TIMES and BUTLER, energy demand profiles have been created for each region separately for 30 climatic years in 2030 and 2050.

### 3.5 References

- Bøeng, A. C., Halvorsen, B., & Larsen, B. M. (2014a). *Kartlegging av oppvarmingsutstyr i husholdningene. SSB Rapport 2014/45*. Retrieved from <https://www.ssb.no/energi-og-industri/artikler-og-publikasjoner/kartlegging-av-oppvarmingsutstyr-i-husholdningene>
- Bøeng, A. C., Halvorsen, B., & Larsen, B. M. (2014b). *Oppvarming i boliger. Kartlegging av oppvarmingsutstyr og effektiviseringstiltak i husholdningene. NVE Rapport 85/2014*. NVE.
- Bøhn, T. I. (2020). Energimerkedatabasen uttrekk, XML-data 07.10.2020.
- Directorate-General for Energy. (2019). *Comprehensive study of building energy renovation activities and the uptake of nearly zero-energy buildings in the EU. Final report*.
- Fjellheim, K., Lien, S. K., Walnum, H. T., Sandberg, N. H., Cheng, C., & Fjellheim, Ø. (2020). Energitjenester i næringsbygg Potensial- og barrierestudie.
- Lien, S. K. (2017). *Innvirkning av Norges energipolitikk på fremtidig energibruk i norsk bygningsmasse*. NTNU. Retrieved from <https://ntnuopen.ntnu.no/ntnu-xmlui/handle/11250/2440468>
- Multiconsult AS, & Analyse & Strategi AS. (2012). *Potensial- og barrierestudie: Energieffektivisering i norske yrkesbygg. Bakgrunnsrapport. Enova rapport*.
- Olje- og energidepartementet. (2009). FOR-2009-12-18-1665 : Forskrift om energimerking av bygninger og energivurdering av tekniske anlegg (energimerkeforskriften). Retrieved from <http://www.lovdata.no/for/sf/oe/oe-20091218-1665.html>
- Sandberg, N. H. (2017). *Dynamic modelling of national dwelling stocks. Understanding phenomena of historical observed energy demand and future estimated energy savings in the Norwegian dwelling stock*. Norwegian University of Science and Technology.
- Sandberg, N. H., Naess, J. S., Brattebø, H., Andresen, I., & Gustavsen, A. (2021). Large potentials for energy saving and greenhouse gas emission reductions from large-scale deployment of zero emission building technologies in a national building stock. *Energy Policy*.
- SSB. (2020). 11561: Energibalanse. Tilgang og forbruk, etter energiprodukt 1990 - 2018. Retrieved June 2, 2020, from <https://www.ssb.no/statbank/table/11561>
- Statistics Norway. (2018). Befolkning (Population).

## 4 Simulating heat load profiles in buildings using mixed effects models

*Jaume Palmer, Jan Kloppenborg and Henrik Madsen (DTU)*

In order to plan and develop strategies for the future power market, it is necessary to create tools that reliably represent it. Such tools need to be able to predict the energy consumption of the different systems that form the energy landscape. Buildings are a key component of this landscape since they take a significant portion of the total energy use. In this work, we propose a model for simulating the space-heating consumption of buildings based on linear mixed effects model.

There are factors that impact the heat consumption of a building that can be especially difficult to measure. A clear example is the behaviour of the occupants; predicting it is far from being trivial due to their noisy nature and intrusive measurement set ups. A long-term forecasting tool needs to account for such phenomena to be general enough to represent the existing variety of the building stock. This means capturing the inherent differences from building to building, caused by random unobserved events. For this reason, we propose using mixed effects models for the stochastic simulation tools. Mixed effects models combine fixed effects that capture the influence of variables that affect all buildings equally. In addition, the model proposed here contains a random term to account for the individual differences between buildings. This addition reduces model complexity, quantifies the differences between observed buildings and facilitates predicting the consumption from unobserved ones.

This model returns the time-series of energy consumption of a building during a given period, given the building type and weather conditions. Thus, the model captures the dynamic nature of heat consumption. Additionally, the model can be used to evaluate the consumption pattern changes for buildings with different efficiency label.

### 4.1 Mixed effects for Buildings

There are factors that affect the energy consumption of buildings that are difficult to identify and measure, such as the preferences of the building users. Such factors cause random differences between the energy behaviour of individual buildings. The cause of those differences can be understood as a stochastic variable ( $U$ ), or *random effect*. Then, using a mixed model, it is possible to identify the distribution of the stochastic variable that characterizes the differences between individual buildings. As summarized in Figure 40, estimating the distribution has two different outcomes:

- **Profiling.** Using the observations to estimate the random effects of each building from the measured ensemble of buildings.
- **Sampling.** Simulating a representative realization of a building that has not been observed, using random effects sampled from the estimated distribution.

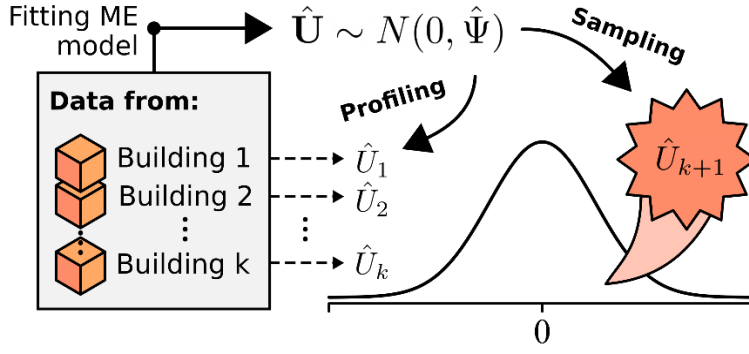

Figure 40. Schematic representation of the outcomes of fitting a mixed effects model.

The proposed model for simulating the heat load ( $\Phi_{i,t}$ ) is

$$\Phi_{i,t} = \underbrace{\left[ \sum_{j=1}^{24} \rho_j I_{\{t \in j\}} + W_t \sum_{j=1}^{24} \rho_j I_{\{t \in j\}} \right] I_{\{t \in \Omega_{WD}\}} + \theta_1 + \theta_2 W_t + \theta_3 \Delta T_{i,t}}_{\text{Fixed effects}} + \underbrace{U_{i,2} + U_{i,3} W_t + U_{i,4} \Delta T_{i,t}}_{\text{Random Effects}} + \varphi_1 \epsilon_{i,t-1} + \xi_{i,t} + \varphi_1 \epsilon_{i,t-1} + \xi_{i,t} + \varphi_1 \epsilon_{i,t-1} + \xi_{i,t} + \varphi_1 \epsilon_{i,t-1} + \xi_{i,t} + \varphi_1 \epsilon_{i,t-1} + \xi_{i,t}$$

Hence, the model in the previous equation discerns between heating and non-heating season. The model accounts for a fixed hourly schedule, which depends on the aforementioned season. Additionally, each season has a fixed heating baseline. Then, the weather effects are introduced through the variable  $\Delta T_{i,t}$ , that is positive during heating season, and zero otherwise. Furthermore, the variables  $\{S_t, W_t, \Delta T_{i,t}\}$  have a random effect over the heat load, i.e., the seasonal heating intercept and the effects of the weather might vary from building to building. Finally, given the hourly sampling, an auto-correlation term has been added in the residuals.

## 4.2 Results for schools

Mixed effects models can be used to simulate the behaviour of a new unobserved building (sampling). In this section, the model presented has been fit using the training set and the simulated consumption has been compared to the test data. The data comes from 33 schools: 25 of them have been used to train the model; then, the simulation results have been compared to out-of-sample data from 8 remaining schools.

Figure 41 shows the model prediction given the temperatures of the month of February 2010; where, it can be noticed that the model simulation follows closely the trend of the test data. As expected, this trend shows clear peaks during the workdays and a flatter trend during the weekends. The simulation under-predicts the highest peaks taking place in the morning of workdays. When the morning peaks are captured, the valleys at night are over-predicted, which highlights the difficulty of capturing sudden changes in heat consumption. Since the simulation is stochastic, the prediction interval (PI) of the simulation has been computed. The interval quantifies the uncertainty of the simulated consumption, mainly due to the differences from building to building. As expected, this prediction interval shows a constant width during

the whole time-series due to the assumption of normally distributed noise. It is easy to see that, in this February example, the prediction interval includes practically all test data points.

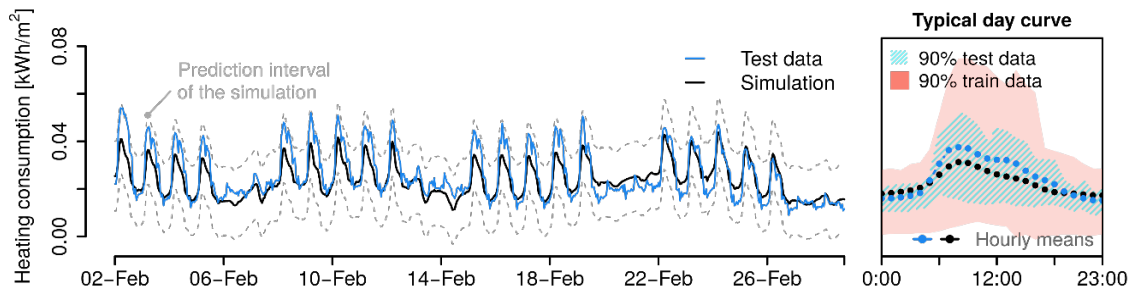

Figure 41. Comparison of the simulated data and a test set for the month of February 2010.

In addition, Figure 41 includes the daily profile of the prediction and the test data. It can be observed that the typical day curve of the simulation is lower than the testing data during the working hours. This damped trend in the simulation might be due to the range difference between the training and testing set. As it can be seen, the hourly range of data points of the training set is significantly wider than test set. This model is fitted with data from all year round, so it has been possible to simulate heat consumption for every month. Figure 42 shows the typical daily consumption for every month of 2010. The simulated curve and the test curve follow a similar pattern during the colder months. Notice that the daily baseline consumption decreases during the summer, where only the hour effects are present. During June, July and August the test consumption is virtually zero, and the simulation still shows a low periodic hourly pattern. Nevertheless, Figure 42 also includes the percentage of test data points that fall inside the 90% prediction interval of the simulation. For the whole year, practically all test data falls inside the expected region.

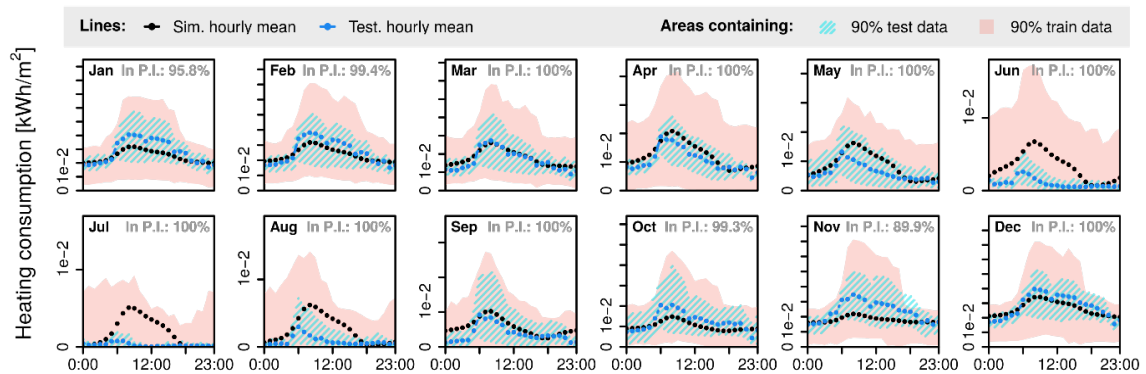

Figure 42. Typical days for every month of the year 2010. Every month includes the % of test data that falls inside the 90% prediction interval, denoted by "In P.I.".

### 4.3 Discussion and next steps

The results in this work show the potential of mixed effects models to be used to forecast long-term energy consumption of buildings. These models are a natural extension of fixed effects models, that have been proven successful in past work. Mixed effects are able, not only to generate a representative prediction of the heat consumption in buildings, but also, they estimate the inherent uncertainty of the simulation due to non-measured events. There is still room for improvement in the current version of the model. Although all test values fall inside



the prediction interval, the simulation mean shows damped peaks, when compared to the test data. In addition, practically 100% of test data falls inside the 90% prediction interval, which hints that such interval should be narrower. Similarly, the interval is symmetric and constant. However, a more realistic model would have a prediction interval that: i) is asymmetric since consumption can only take positive values; and ii) is wider when consumption is expected to be higher. These limitations come from the assumption that the modelled data follows a gaussian distribution. In the future, different distribution families will be used, to consider such issues. In addition, the dependence of the weather can be improved. Despite these issues, the results are promising enough, and the next steps well defined to pursue further this methodology with a more complete model. Ultimately, given the generality of modelling with mixed effects, the work presented here can be extended to other building categories to simulate a broader energy landscape.

## 5 Power system in Europe and its influence in Norway: Preliminary results from EMPIRE

*Raquel Alonso Pedrero, Mohammadreza Ahang, Pedro Crespo del Granado,  
Asgeir Tomasgard (NTNU)*

### 5.1 Introduction to EMPIRE

EMPIRE is categorized under power system models that utilizes the aggregated data regarding electricity consumption, techno-economic data related to different technologies and transmission lines to maximize the social welfare. Therefore, EMPIRE is a linear techno-economic model formulated as the multi-horizon stochastic program. The model is designed to evaluate European power system transition with emphasis on large shares of VRES. The structure of EMPIRE is made from a set of nodes connected with arcs. Nodes are responsible to balance electricity demand and supply in each country, while arcs facilitate electricity exchange between countries.

The mathematical formulation of EMPIRE is two-stage stochastic program. The model makes decision about investment or capacity expansion of power system assets in specific period  $i$  through first stage decisions,  $x_i$ . EMPIRE considers short-term uncertainties as the stochastic part of model, therefore the second-stage decisions or operations,  $y_{i,\omega}$ , in alternative stochastic scenarios,  $\omega$ , may behave differently. The abstract model is represented in the following way:

$$\min_{x,y \geq 0} \sum_{i \in \mathcal{I}} c_i^T x_i + \sum_{\omega \in \Omega} \pi_\omega \sum_{i \in \mathcal{I}} q_i^T y_{i,\omega} \quad (1)$$

$$\text{s.t.} \quad \sum_{i \in \mathcal{I}} A_i x_i = b \quad (2)$$

$$T_{i,\omega} x_i + W y_{i,\omega} = h_{i,\omega} \quad i \in \mathcal{I}, \omega \in \Omega \quad (3)$$

The objective (1) consists of two main parts discounted investment costs,  $c_i$ , and operational costs,  $q_i$ . Operations,  $y_{i,\omega}$ , are scenario dependent and the scenario probability,  $\pi_\omega$ , represent weights corresponding to each scenario. Broadly speaking, the objective minimizes the sum of total discounted costs in period,  $i$ , and scenario  $\omega$ . Constraint (2) represents the link between different investment periods, where investment decisions,  $x_i$ , are bounded by maximum capacity expansion,  $b$ , and weighted by asset lifetime  $A_i$ . Apart from assets characteristics, investment decisions depend on the uncertain short-term decisions subject to VRES. Hence, the connection between long-term and short-term decisions in period  $i$  and scenario  $\omega$  is crucial and represented by constraints (3), where the coefficient of  $x_i$  is asset availability factor,  $T_{i,\omega}$ , and  $W$  is assets characteristics regarding operations e.g. efficiencies. On the right hand side,  $h_{i,\omega}$  shows demand and power system assets limitations.

EMPIRE has totally six stochastic processes include availability of solar generation, onshore wind generation, offshore wind generation, hydro run-of-river generation, regulated hydro generation, and electricity load. Different realization of these stochastic processes makes a set of various stochastic scenarios  $\omega$ . According to stochastic processes in EMPIRE,  $T_{i,\omega}$  and  $h_{i,\omega}$  are stochastic parameters. EMPIRE has short-term temporal resolution includes four weeks and each week has 168 consecutive hours representing seasons of a year. Each decision stage is connected with a specific long-term period, for instance in EMPIRE the distance between two consecutive period is five years. Figure 43 gives a general overview of the inputs, the results and the features of the model.

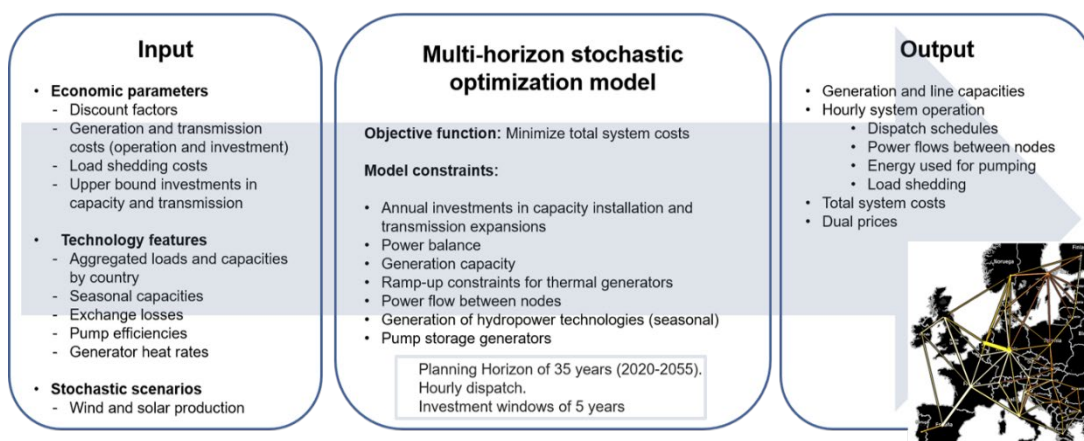

Figure 43. Diagram representing the EMPIRE model

## 5.2 EMPIRE in FLEXBUILD

### Storylines for Europe

The storylines defined for FLEXBUILD in the previous annual report were developed merely for the Norwegian context. Therefore, we required to extend these to the European context in a way that can be incorporated to EMPIRE. The premise was to adopt the storylines the development of Europe to be aligned in goals and objectives with those of Norway.

In Table 11 we define the FLEXBUILD storylines for Europe. They entail four main features: CCS development, transmission capacities between countries, technology curves and the future of fossil-fuel based technologies. Note that the technology learning curve refer to the future technology costs and the technology improvement (e.g., efficiency).

Table 11. Translating four storylines into EMPIRE

Storyline	CCS	Transmission	Technology learning curves	Gas/oil
<b>Energy Nation</b>	NO	+20% ENTSO-E limits	High	2050 phase out
<b>Nature Nation</b>	YES	ENTSO-E limits	Moderate	2050 phase out
<b>Petroleum Nation</b>	YES	Higher than ENTSO-E	High	No phase out
<b>Climate Panic Nation</b>	NO	ENTSO-E limits	High	2030 phase out

In the following section, we focus on understanding the Energy Nation storyline. In line with the Norwegian context, this case study promotes the electrification and the collaboration between European countries. At the same time, fossil technologies are no longer in the market, thus CCS is not commercial.

### Input data and assumptions – Energy Nation

In this section, we will elaborate on the Energy Nation storyline and the possible harmonization between Energy Nation and the base scenario in EMPIRE. Global warming is the centre of attention in the storyline; thus two drivers have pivotal function: policy exertion and technology development.

The CO<sub>2</sub> budget restriction is one of the instruments to satisfy the political willingness to reduce GHG. EMPIRE uses CO<sub>2</sub> budget to be aligned with environmental regulations at the European level. In this case, CO<sub>2</sub> emission should decrease around 95% compared with 1990's

emission level. In addition, renewable energy is considered to be supported, what is reflected in the capital and operational costs.

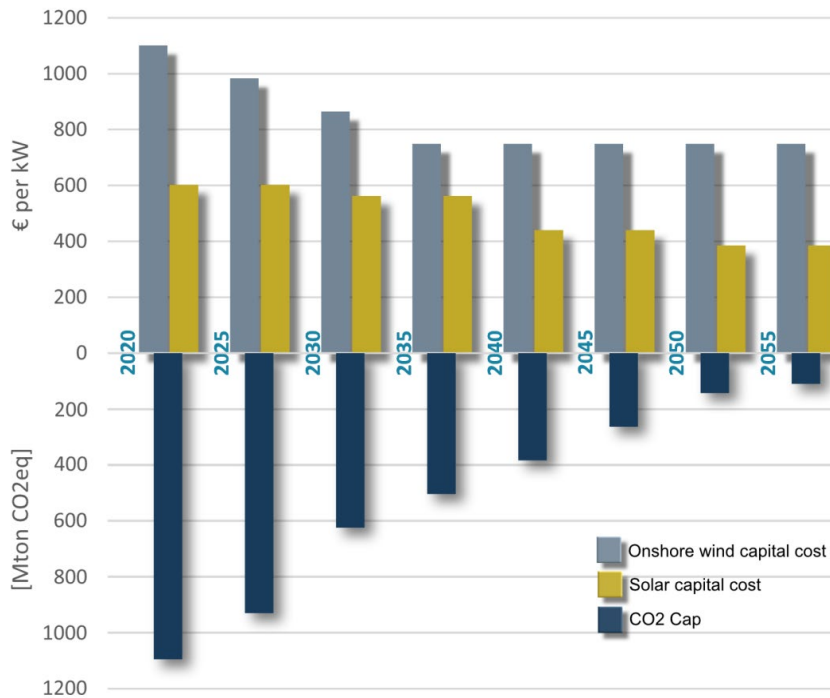

Figure 44. The effects of technological development and environmental policies on capital costs of stochastic processes and Co2 cap respectively, by 2055

Reduction in fossil fuel demand is one of the consequences of high share of renewable in power system, hence it can affect the price of fossil fuels. We assumed that the prices of fossil fuels will drop by 20% compared to base scenario. This fact cannot provide incentives to invest in new fossil-fuel-based power plants, because one of the assumptions in this storyline is the absence of CCS technologies. Indeed, the lack of CCS technology and restricting CO<sub>2</sub> budget are two main barriers to invest in these technologies.

Demand side in the Energy nation storyline is supposed to experience high degree of electrification. Electricity demand per investment period in EMPIRE is input data, therefore we need to use demand volume from another energy system model (GENeSYS-MOD) after electrification.

See Appendix D: European power system for further details on the European electricity demand projections and the fossil-fuel costs.

### 5.3 Preliminary Results – Energy Nation

EMPIRE has a broad range of outputs related to the development of the European power system. In the following section, we present the preliminary results for the Energy Nation storyline at the European level. First, we introduce the expected technology mix of the system until 2055. Afterwards, we focus on the relevant output results for Flexbuild which are the electricity prices and power trades in the neighbouring countries of Norway.

The preliminary results show that the high share of renewables in the system without any CCS technology may affect electricity prices considerably, moreover the mix of electricity trade between Norway and neighbouring countries largely depends on the electricity prices. Broadly speaking, apart from technology novelty, different sources of flexibility from demand side are able to influence the electricity prices and trade.

## Capacity and generation in Europe

The installed capacity and annual generation of Europe until 2055 are shown in Figure 45 and Figure 46, respectively. As expected, wind and solar technologies become the main source of European electricity specially after 2030. On the contrary, technologies such as coal (including lignite) and nuclear are gradually replaced. Gas and oil are phased out by 2050 as defined by the Energy Nation storyline. Particularly, the decrease of gas is quite abrupt. Also, the generation is not stable through the years between 2030 and 2050. On the contrary, hydropower generation and capacity remains quite stable compared with actual values. By 2050 we can expect that the importance of bio technologies to increase considerably.

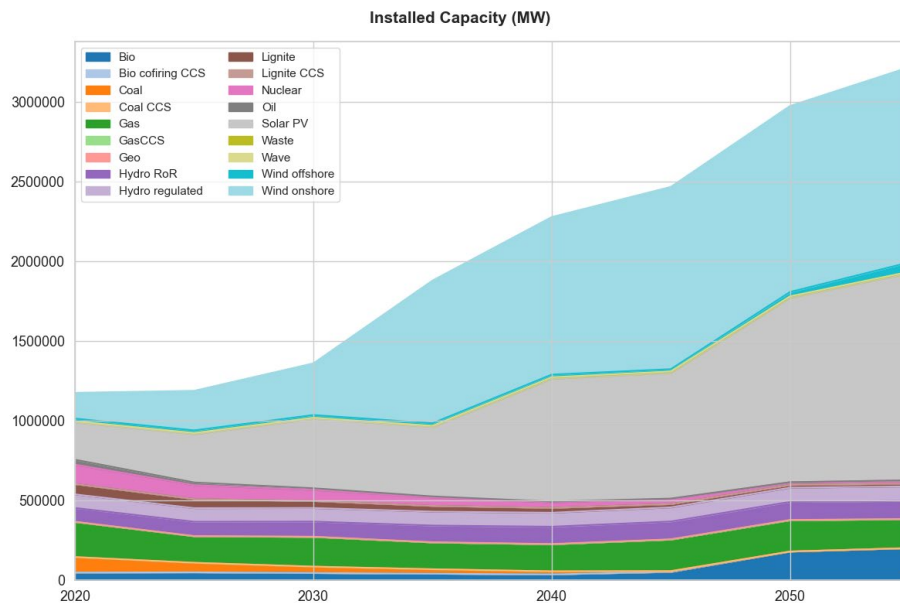

Figure 45. Installed Capacity for Europe (MW)

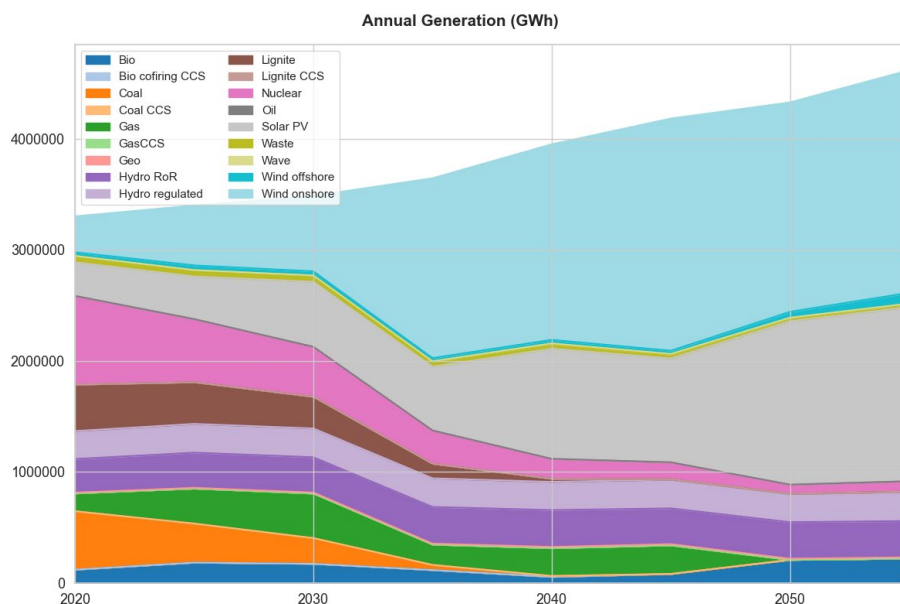

Figure 46. Annual generation (GWh)

## Price developments

The system operation is governed by a number of energy balance constraints, one for every node and every dispatch hour considered, and a number of technical constraints for the

generators and interconnector links between nodes. The collection of all of the following constraints for a period  $i \in \mathbf{I}$  and stochastic scenario  $\omega \in \Omega$  define the annual dispatch of the system.

The nodal load is by this design price insensitive, apart from highly constrained supply situations when load can be shed at the cost of value of lost load. The shadow prices of the node load balance constraints are reported as power prices. Uncertainty in the load profiles is introduced by using unique input data for every  $\omega \in \Omega$ .

Hourly production and nodal loads for different stochastic scenarios are important components of balance constraints. Apart from electricity demand, the high share of renewable energy and the probabilities of the stochastic processes influence the electricity prices in each node.

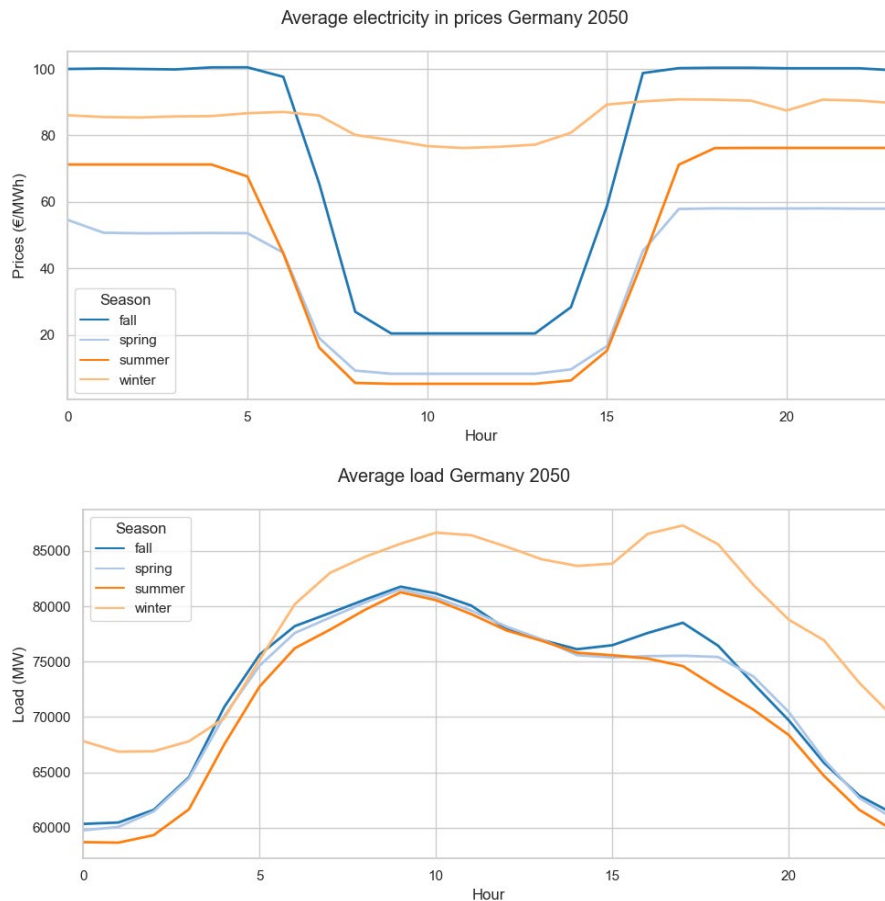

Figure 47. Average prices and load in Germany (2050)

Figure 47 depicts the average hourly electricity prices for representative days in Germany for the period 2050-2055. As expected, the prices during the winter are higher than for other seasons. However, during the first and last hours of the day, the average price during the fall surpasses winter prices. This occurs despite a higher average load during the winter. This is explained by the substantial difference in wind production for those hours, especially for the onshore wind (see Figure 87 in Appendix D: European power system). Meanwhile, during the day, the solar production in the winter is lower than in the other seasons, thus the prices are higher for those hours of the day.

### Electricity Trading: Norway and neighbouring countries

The results of the transmission capacities by 2020 and 2050 for the Energy Nation scenario are shown in Table 12. The Energy Nation scenario assumes an increase of current ENTSOE limits of 20%. By relaxing the capacity constraints together with the low investment costs, the capacity in transmission lines is expanded at its maximum capacity. In regards to the differences between years, we see how the installed capacity with Germany accounts for 10% of the Norwegian interconnections.

Moreover, it is evident by Figure 48 that an optimal decarbonization of the system requires significant power trading. When looking at the Norwegian position, there is a substantial increase of trading activity with neighbouring countries. Particularly, Sweden becomes a major trading participant with the transmission capacity doubled by 2050 (from 2500 MW to 6500 MW) and the total volume of power traded reaching almost 29 000 GWh.

Table 12. Installed transmission capacity between Norway and the rest of neighbouring countries for the Energy Nation scenario

	2025		2055	
	MW	Share	MW	Share
Sweden	2 539	(39.8%)	6 502	(41.6%)
Germany	0	(0%)	1 632	(10.44%)
Finland	110	(1.7%)	734	(4.7%)
The Netherlands	700	(11%)	1 633	(10.4%)
Great Britain	1 400	(21.9%)	3 265	(20.9%)
Denmark	1 640	(25.7%)	1 866	(11.9%)
<b>Total</b>	<b>6389</b>		<b>15 632</b>	

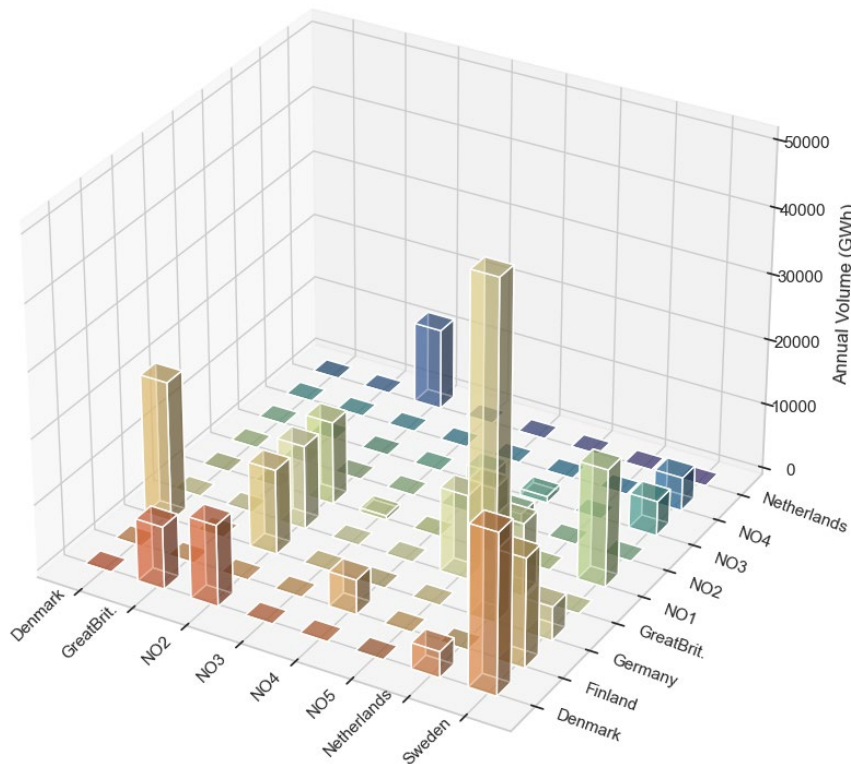

Figure 48. Expected annual trading volumes between countries by 2050 (GWh)

#### 5.4 Further work

Future work will consist of linking TIMES with EMPIRE in order to account for other European electricity prices. The success of bridging between two model's over-reliance on appropriate harmonization. Therefore, it is necessary to harmonize stochastic scenarios, learning curves, and maximum capacity of transmission lines. Detailed description was already presented in section 2.1 Model linking and harmonization.

## 6 Energy system in Norway: Results from IFE-TIMES-Norway

*Pernille Seljom, Eva Rosenberg and Lisa Kvalbein (IFE)*

This section presents TIMES model results for the four storylines: *Energy nation*, *Petroleum nation*, *Nature nation* and *Climate Panic nation* with focus on the electricity and building sector. Appendix E: Energy system model, IFE-TIMES-Norway includes a more corresponding model assumptions and details related to the quantifications of the storylines.

### 6.1 Norwegian electricity generation towards 2050

The electricity generation increase towards 2050 for all storylines but the increase is highly storyline specific. The electricity generation increase ranges from 24 TWh in Nature Nation to 81 TWh in Energy Nation from 2018 to 2050, see Figure 28. The share of PV in the electricity generation mix in 2050 is the lowest in Petroleum Nation, with 2%, and the highest in Energy Nation, with 10%. The share of wind power in 2050 is lowest in Nature Nation, with no new wind power, and the highest in Climate Panic Nation, with 21%. Consequently, the difference among the storylines indicates that the electricity generation mix in a low-carbon future is highly uncertain.

Note that in this figure, building applied PV generation is included, and the generation thus not equals the high voltage electricity generation.

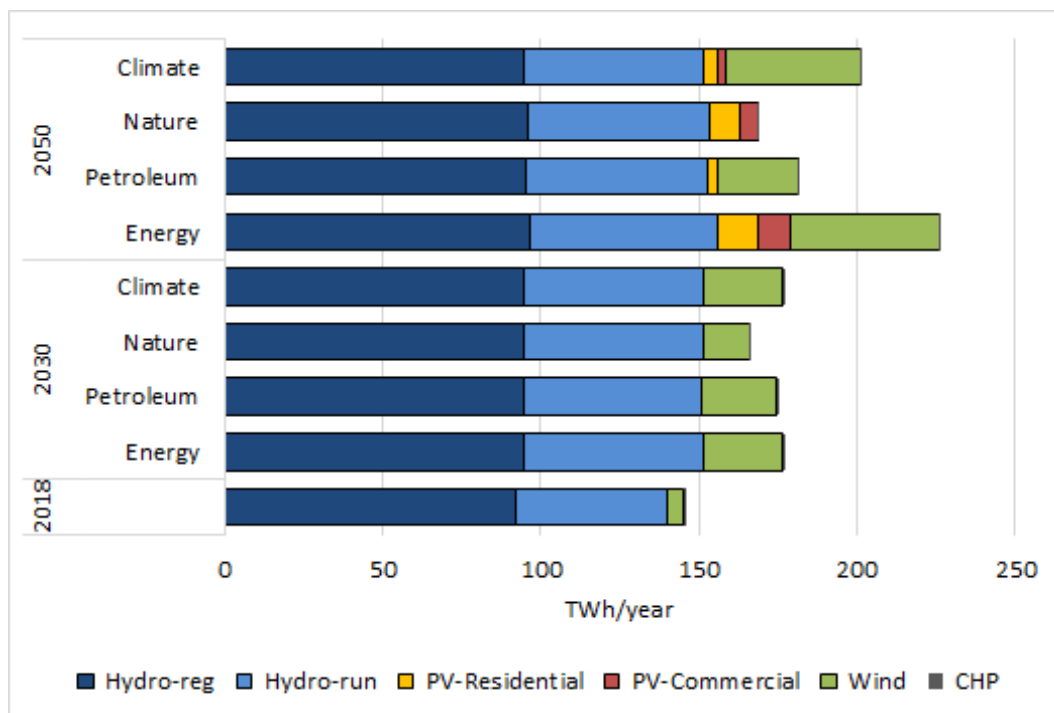

Figure 49. Electricity generation (TWh/year) in 2018 and for the four storylines in 2030 and 2050.

### 6.2 Electricity use

Like electricity generation, the total end-use of electricity increases in all four storylines from 2018 to 2050. The highest increase from 2018 to 2050 is in Energy Nation with 88 TWh/year, and the lowest in Nature Nation with 23 TWh/year, see Figure 29.

Most of the increase occurs in the industry and transportation sectors, while the building sector decreases its use of electricity in all storylines. Compared to the electricity use in buildings in 2018, the electricity use in 2050 is lowered by 2, 1, 5 and 7 TWh/year for Energy, Petroleum, Nature and Climate panic nation respectively.



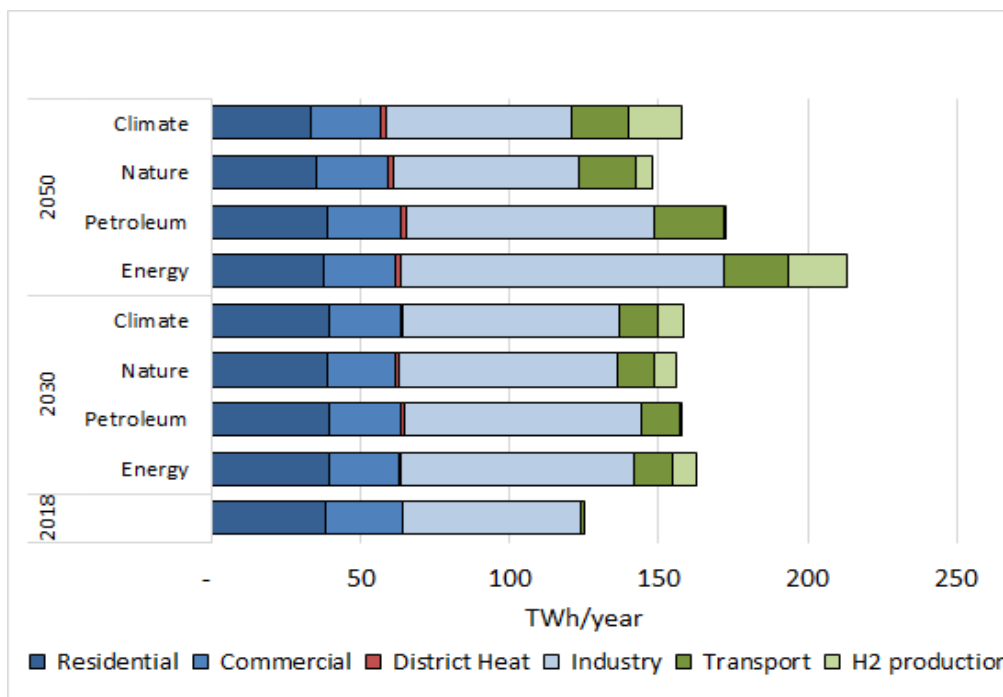

Figure 50. Electricity use (TWh/ year) in 2018 and for the four storylines in 2030 and 2050.

### 6.3 Energy use in buildings

Use of electricity decrease in buildings in all four storylines towards 2050, due to more energy efficient buildings, more use of heat pumps, local PV production and increase use of district heating, see Figure 51. Further, the use of district heat from large-scale systems increases for all storylines from 2018 towards 2030 and 2050. There is considerable growth in small-scale district heating systems, with an about tripling of energy use in 2050 compared to 2018.

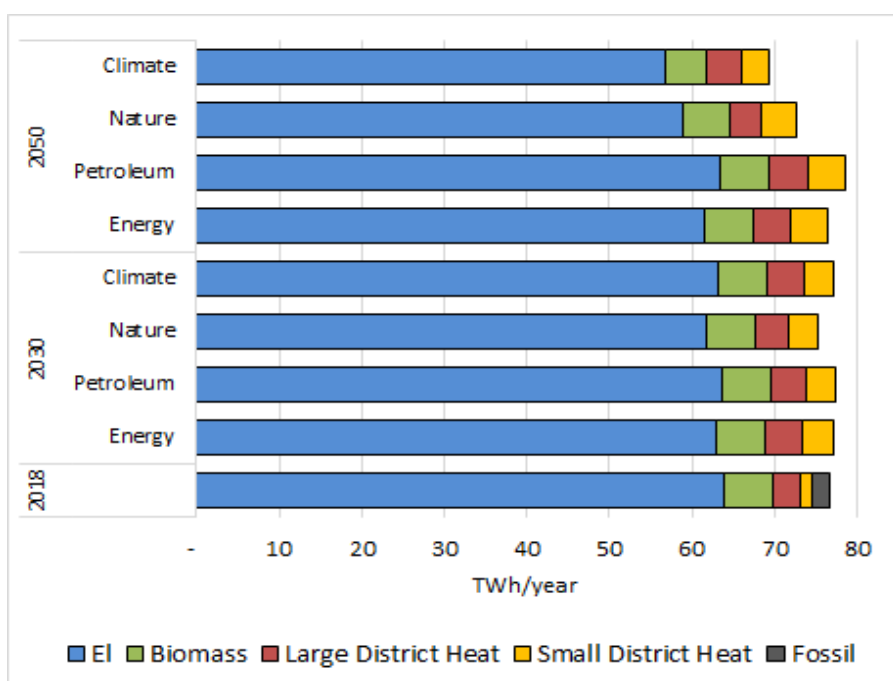

Figure 51. Energy use in buildings (TWh/year) in 2018 and for the four storylines in 2030 and 2050.

### 6.4 Load demand of buildings in 2050

Compared to 2018, the maximum load of buildings in 2050 decreases in all four storylines, except Petroleum Nation in NO1, see Figure 52. This is due to more energy efficient buildings, more use of heat pumps and an increased use of district heating, see Figure 51. Similarly, the

reduction in electricity demand, the load reduction is largest for Climate panic nation, whereas Petroleum nation has the largest peak demand among the storylines.

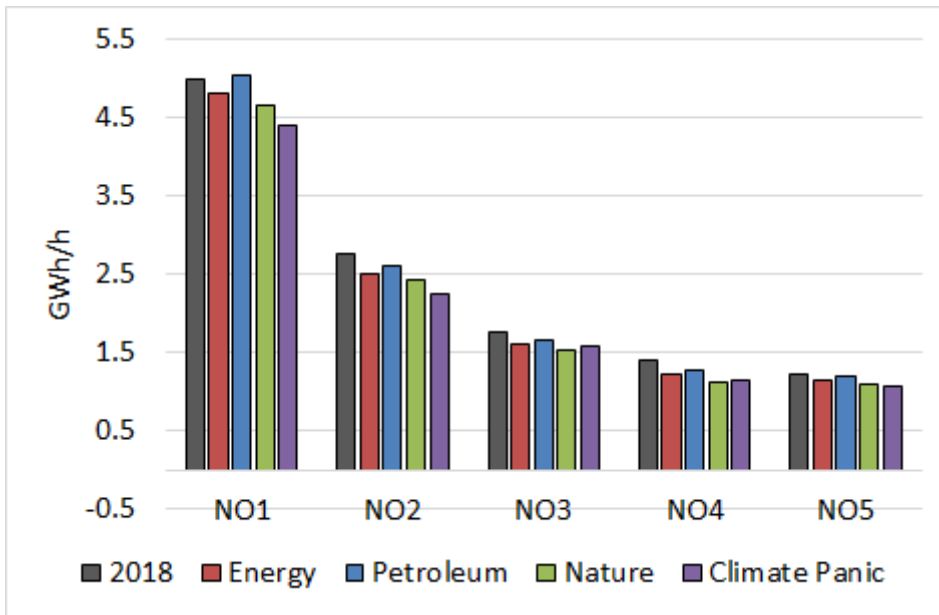

Figure 52. Maximum power load (GWh/h) of buildings in 2050 per region and storyline

## 6.5 Stationary batteries

The investments and use of stationary batteries are highest among the storylines in *Energy Nation* followed by *Nature Nation*, see Figure 53. Since the electricity prices for these storylines have much higher European price variation than the other two storylines, this implies that the development of the European power market is a core driver for investments in building applied PV in Norway. Given our assumptions, in total 30 GWh/h capacity is installed in 2050 in *Energy Nation*, almost zero in *Petroleum Nation*, 14 GWh/h in *Nature Nation*, and 1 GWh/h in *Climate Panic Nation*.

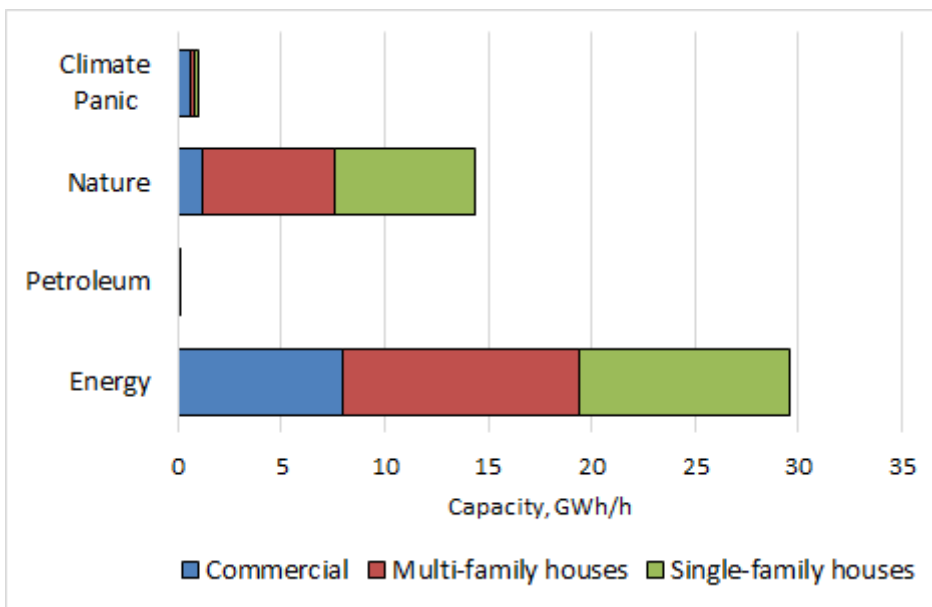

Figure 53. Battery capacity in buildings in 2050 in the four storylines, GWh/h

There are however big differences in the use of batteries among the Norwegian regions, see Figure 54. Most battery capacity is installed in the south, in NO1 and NO2.

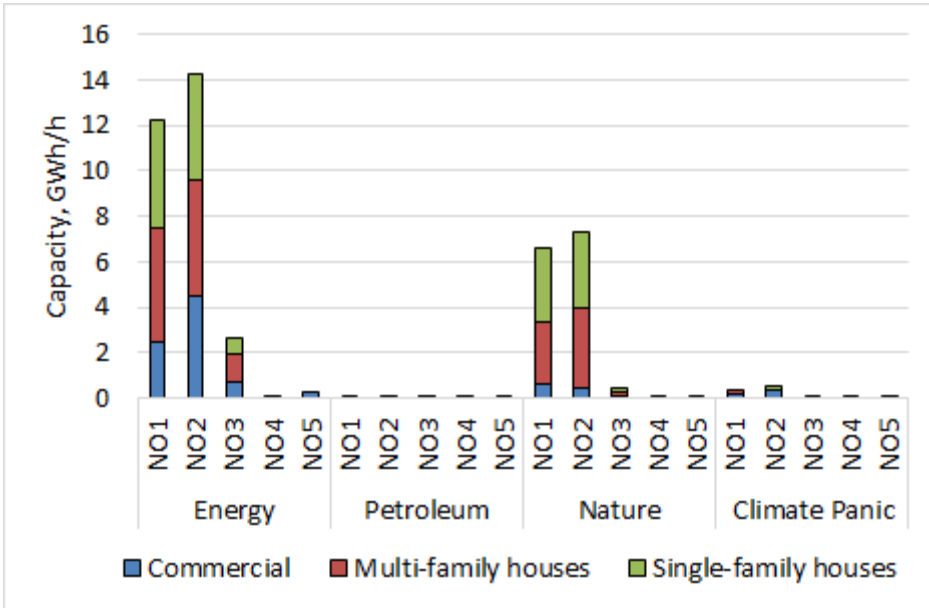

Figure 54. Battery capacity in buildings per region in 2050 in the four storylines, GWh/h

In the residential sector, the use of batteries does not decrease the electricity peak load when we assume today's grid tariff structure. In fact, the peak load is increased by 0.8 GWh/h in NO2. This is related to that the trading electricity prices are lower in the middle of the day, due to a larger share of PV generation.

In commercial buildings, where we assume today's grid tariff structure with a power tariff part, the model results show that batteries contribute to peak shaving, see Figure 55.

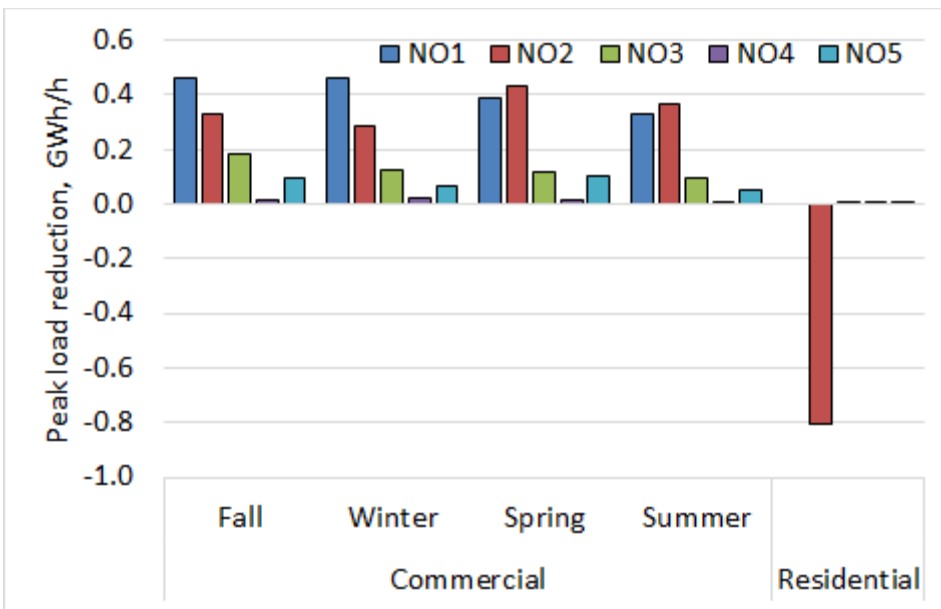

Figure 55. Peak load reduction per region in Energy Nation 2050, GWh/h

The effect of use of stationary batteries in commercial building in 2050 in NO2 in Energy Nation is illustrated in Figure 56. With the use of batteries, the peak load is reduced, and in this case the demand of electricity from grid becomes flat during a winter day.

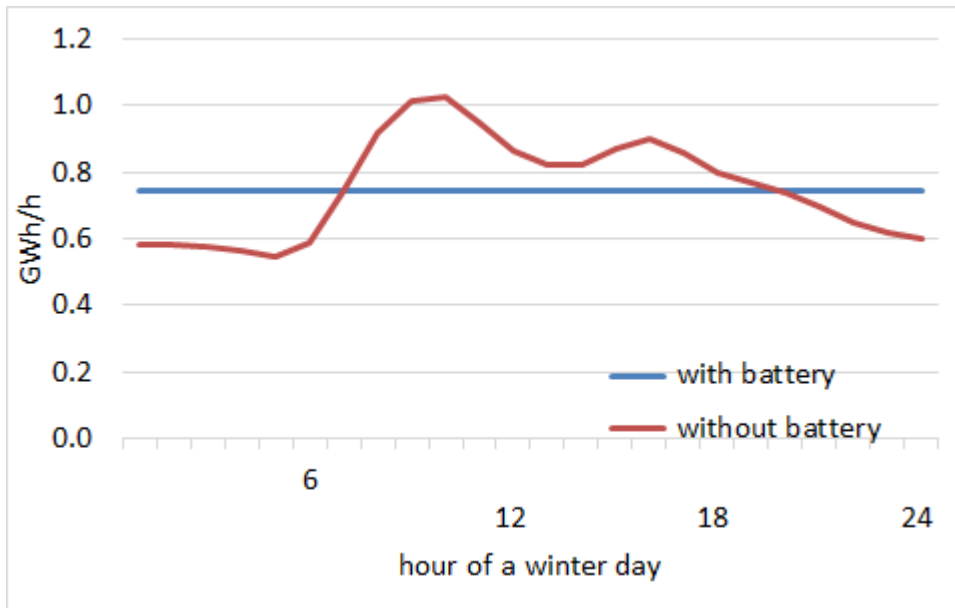

Figure 56. Effect of use of stationary batteries in commercial building a winter day in 2050 in NO2 in Energy Nation, GWh/h

### 6.6 Flexible electric water heater

The capacity of the flexible electric water heater with the given assumptions earlier as well as excluding the use of batteries in buildings is presented in Figure 57. This is very preliminary data that must be further analysed, and the modelling of flexible electric water heater will be improved, but these first results indicated that the effect of flexible electric water heater is mainly a robust flexibility regardless scenario but also that it is dependent on the variation in electricity prices.

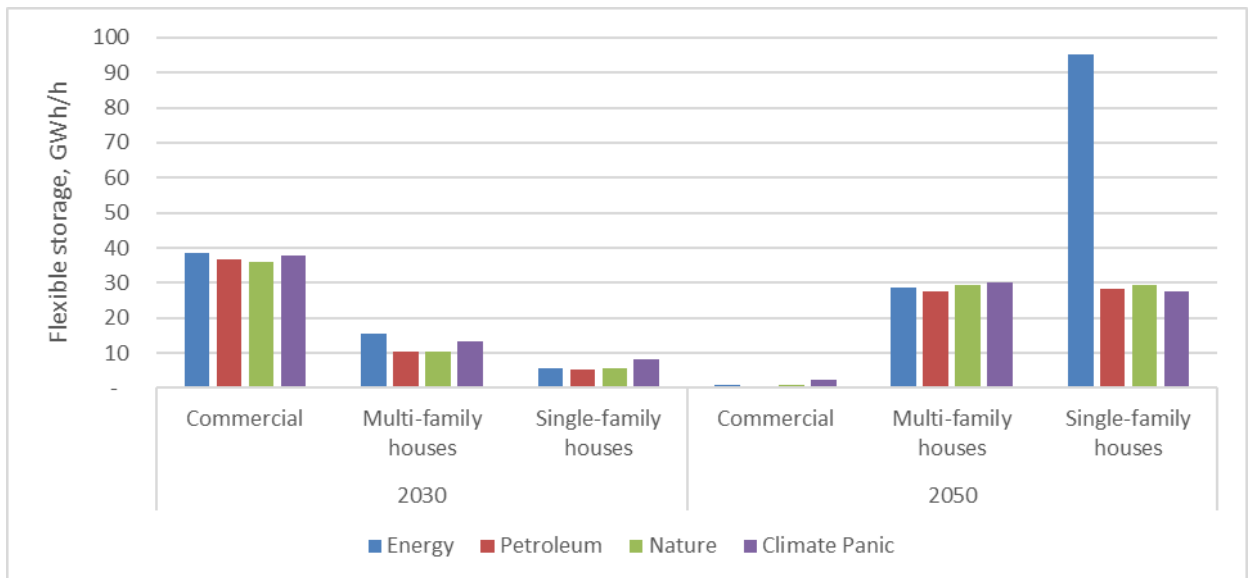

Figure 57. Flexible storage in electric water heater in 2030 and 2050 in the four storylines, GWh/h

As for batteries, the effect is highest in NO1 and NO2, see Figure 58.

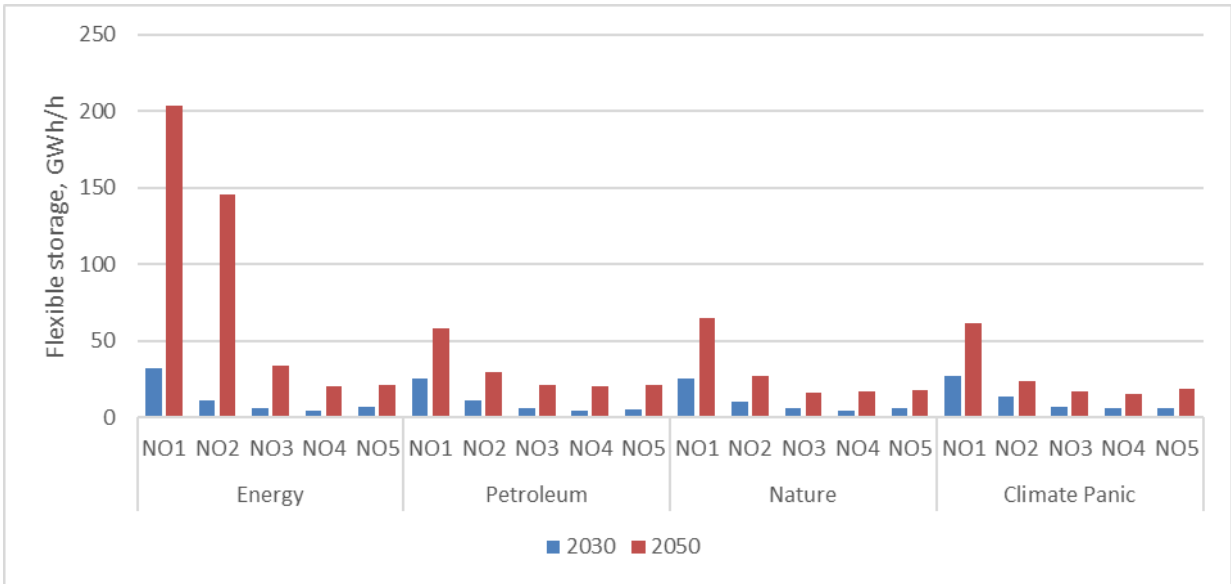

Figure 58. Flexible storage in electric water heater in 2030 and 2050 per region in the four storylines, GWh/h

The use of flexible electric water heater reduces the peak load in commercial buildings, see Figure 59 and Figure 60. Since there is no incitement to peak shaving in the grid tariffs for households, the peak load both increase and decrease, dependent on electricity prices. The use of a flexible electric water heater is higher in the summer in commercial buildings in *Petroleum Nation* compared to *Energy Nation*, due to different electricity prices partly because of the assumption of CCS in *Petroleum Nation* and no CCS in *Energy Nation*.

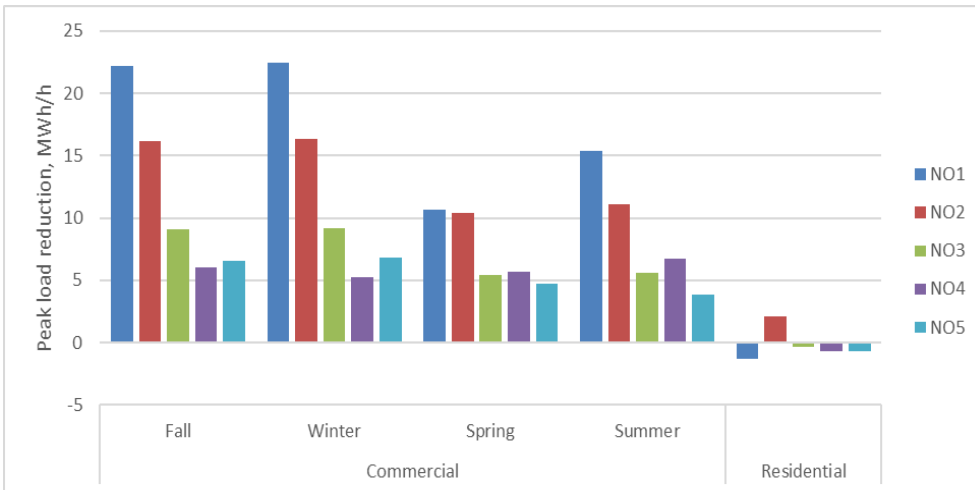

Figure 59. Peak load reduction per region in Energy Nation 2050 with use of flexible electric water heater, GWh/h

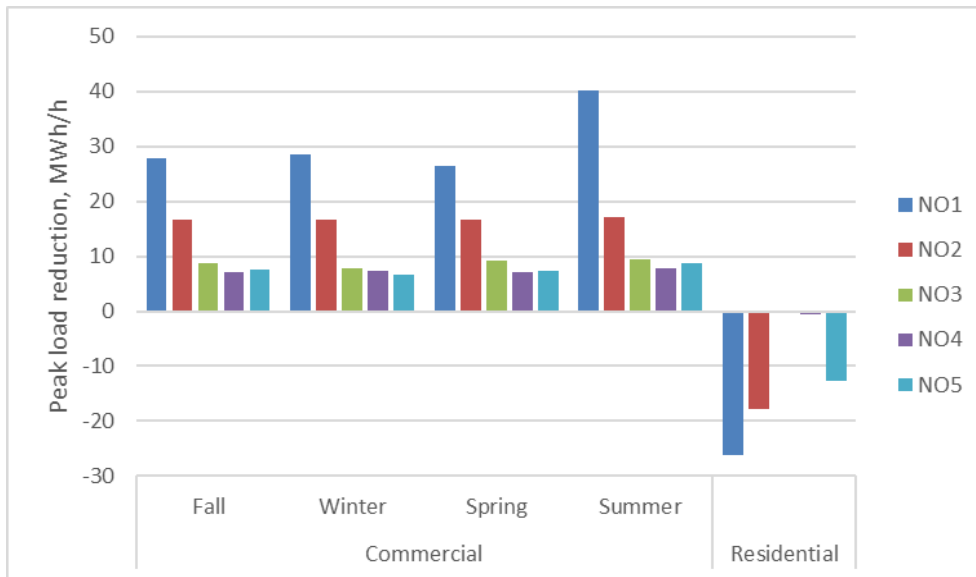

Figure 60. Peak load reduction per region in Petroleum Nation 2050 with use of flexible electric water heater, GWh/h

The effect of flexible electric water heater on load in single-family houses is illustrated in Figure 61 for *Petroleum Nation* in 2050 in region NO1. The load profile change in summer and winter, due to varying electricity prices. In the summer, local production of PV can be used to shift load at mid-day time. In the winter, trade prices influence the Norwegian electricity price in NO1, encouraging load shifting in the evening.

The local PV production increase by 4% (70 GWh/year) in single-family houses in NO1 in 2050 in *Petroleum Nation*, due to use of flexible electric water heater. The total increase in Norway is 200 GWh in 2050 in the residential sector in *Petroleum Nation*. This effect differs between the scenarios and building sector, see Figure 62.

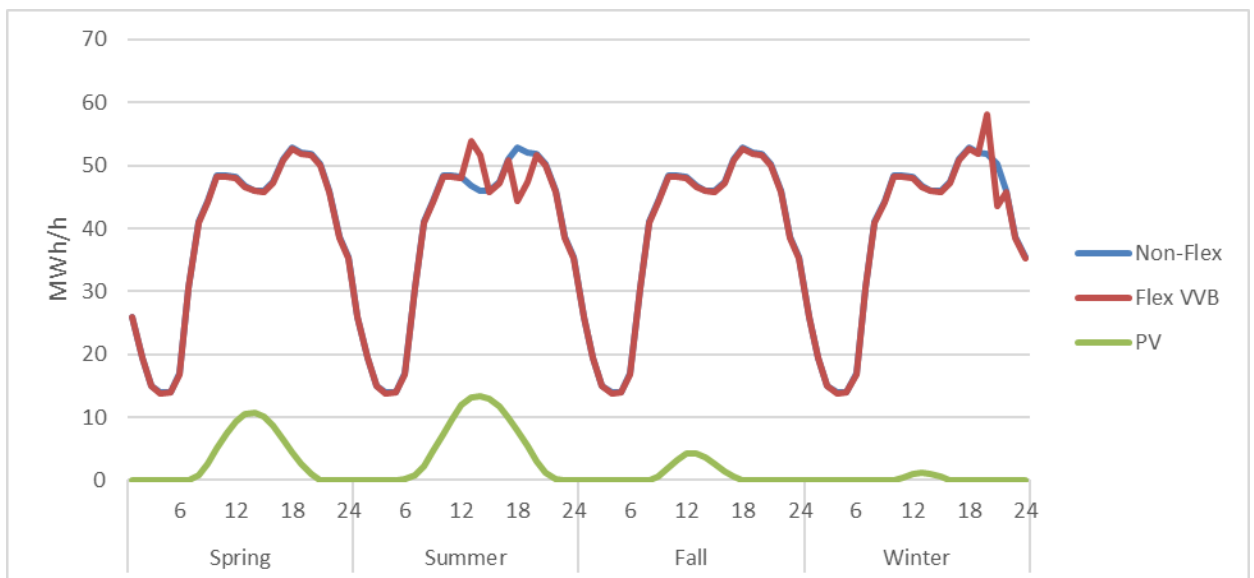

Figure 61. Effect of flexible electric water heater and PV production in single-family houses in NO1 in 2050 in Petroleum Nation, MWh/h

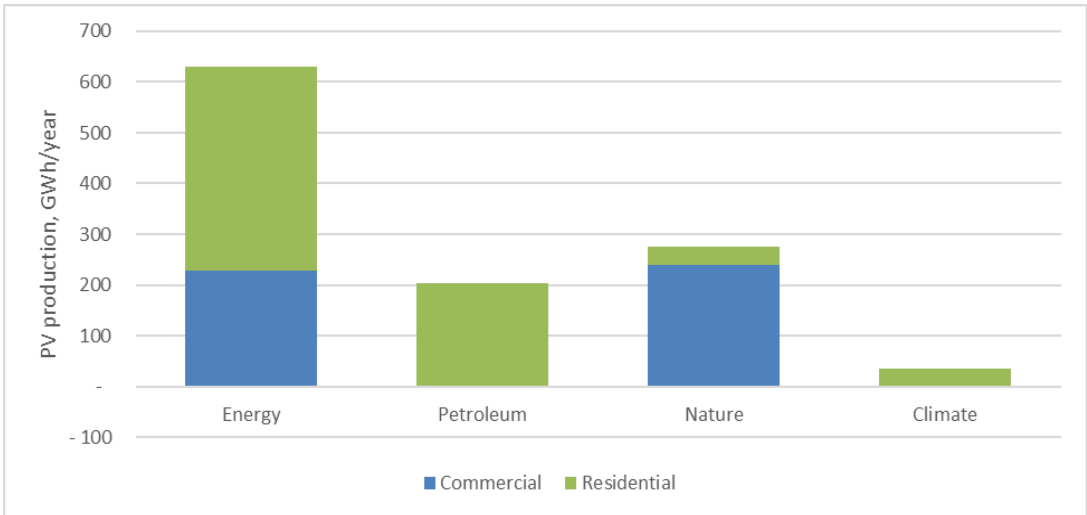

Figure 62. Increased PV production with use of flexible electric water heater in 2050, GWh/year

**6.7 Effect on total energy system costs due to increased flexibility**

To quantify the value of energy end-use flexibility on the Norwegian energy system, we have estimated the value of expanding district heat capacity, stationary batteries and by allowing for partly flexible electricity consumption of hot water heaters. Note that the added value of these flexibility options includes the additional costs that are related to using this flexibility.

The energy system value of these flexibility measures, by the effect on the energy system cost from 2018 to 2060, are presented in

Figure 63. Energy system savings in the period 2018-2060 due to flexible electric water heater, stationary batteries and increased use of district heating, billion NOK.

. Note that the value of all three flexibility options together is not necessarily equal to the sum of each of the separate values. The figure shows that the value of end-use flexibility is storyline dependent, especially the future energy system value of batteries is highly uncertain.

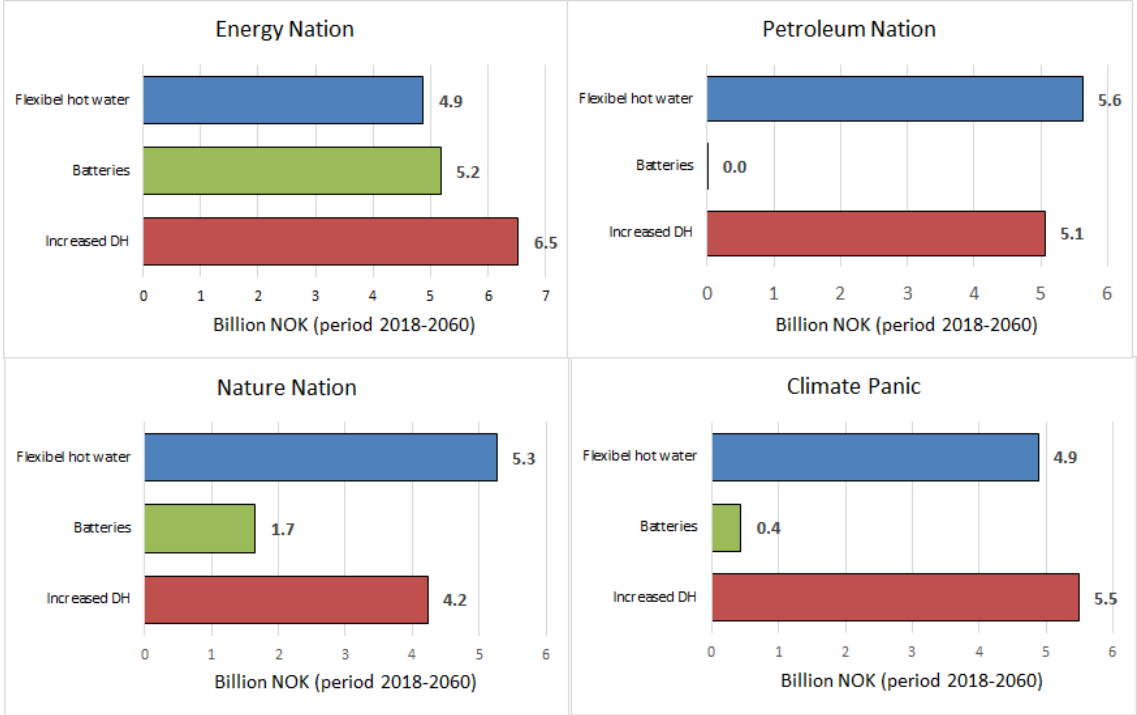

Figure 63. Energy system savings in the period 2018-2060 due to flexible electric water heater, stationary batteries and increased use of district heating, billion NOK.

## **6.8 Further work**

The modelling of district heating will be further improved particularly with a study of use of waste heat ("spillvarme") as a heat source in district heating plants and by including possibilities for thermal storage in accumulator tanks.

Flexible charging of battery electric vehicles will be implemented in IFE-TIMES-Norway to improve the present fixed charging based on the charging pattern of today.

In addition, the flexibility solutions included in year 2, will be further developed and analysed, in order to understand and implement it in the best way.

Different flexibility possibilities will be studied and compared with advantages and disadvantages and, if possible, winners and losers of end-use flexibility will be presented.



## 7 Hydropower system in Norway: Results from EMPS

Mari Haugen (SINTEF Energi)

Hydropower is the backbone in the Norwegian power system and will continue to play the lead role also in the future. To analyse the effect of end-use flexibility on hydropower production and flexibility, power market models with a detailed representation of the hydropower system is used (EMPS, FanSi). These power market models are developed for optimization and simulation of hydrothermal power systems with a considerable share of hydropower, and they are used for forecasting and planning in electricity markets.

In this project we used a scenario based on a 2030 low emission scenario developed in FME HydroCen and later updated to conform with NVE's latest long-term market analysis for 2020-2040. The scenario has a spatial resolution of 57 areas (onshore and offshore) with transmission capacities between them, covering the North-Western European system. We use 30 historical weather years to account for variations in inflow, wind power production and other weather-related input data. The scenario has a detailed description of the Nordic hydropower system, with more than 1000 individual hydropower modules represented. The production and consumption data for Norway are harmonized with results for the Energy Nation scenario for 2030 from the TIMES-NORGE model.

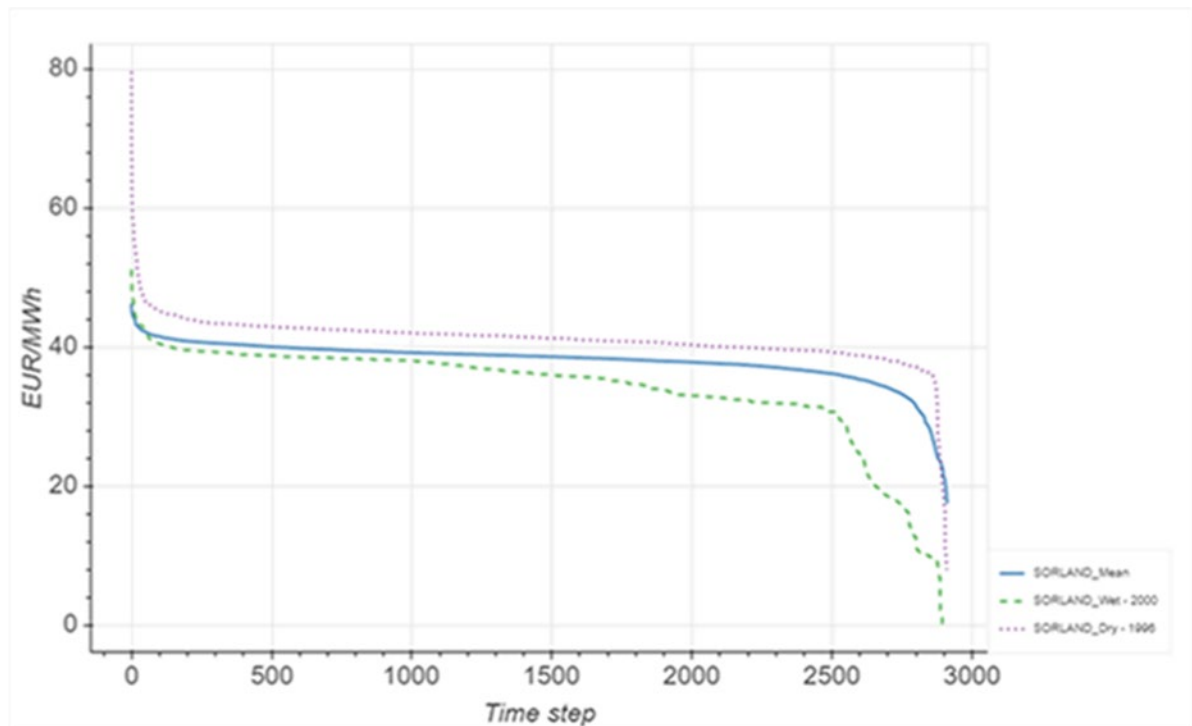

Figure 64. Duration curves for simulated power prices (EUR/MWh) in NO2 in an average year (the average of all inflow scenarios), a high-inflow year (2000) and a low-inflow year (1996).

For the preliminary results presented here, the EMPS model is used. Later in the project, we will use the FanSi model which is developed to better capture the short-term flexibility in the system. Figure 64 show the simulated power prices (EUR/MWh) from the EMPS model for NO2. The blue line represents the average prices over all 30 inflow years (1981-2010), while the purple dotted line and the green dashed line show the variation in power prices between a low-inflow year (1996) and a high-inflow year (2000), respectively. This figure illustrates both how the power prices vary within a year, but also that the power prices in Norway are very much dependent on the inflow.

## 7.1 Economic value of flexible supply from hydropower

The ability of a hydropower plant to store water in an upstream reservoir and thus regulate production, adds flexibility to the power system and is a known property of the Norwegian system. A regulated power plant can, to a larger extent than un-regulated (or run-of-river) power plants, produce when the prices are high. When prices are low, water is stored in the reservoir. To measure the value of this flexibility, we can compare the achieved power price (the total income divided by the total production) for a regulated power plant and an un-regulated power plant. The total yearly production and income, and the achieved power prices is found in Table 13 and Table 14 for a regulated and an unregulated power plant, respectively. The average values are shown together with the values for a high-inflow year and a low-inflow year. The results show that on average the regulated power plant achieves about 1 EUR/MWh higher price than the un-regulated power plant. The results also show that the production from a hydropower plant varies substantially between a low- and a high-inflow year, but that the income is not as variable due to higher power prices in years with low inflow (as seen by the achieved price and by the curves in Figure 64).

Table 13. Total production, total income and achieved power price for a regulated power plant in NO2 for an average year, a high-inflow year, and a low-inflow year.

	<b>Total production [GWh]</b>	<b>Total income [MEUR]</b>	<b>Achieved price [EUR/MWh]</b>
<b>Average</b>	4462.5	176.1	39.46
<b>High-inflow (2000)</b>	5078.3	183.1	36.07
<b>Low-inflow (1996)</b>	3246.6	137.7	42.43

Table 14. Total production, total income and achieved power price for an un-regulated power plant in NO2 for an average year, a high-inflow year, and a low-inflow year.

	<b>Total production [GWh]</b>	<b>Total income [MEUR]</b>	<b>Achieved price [EUR/MWh]</b>
<b>Average</b>	507.8	19.5	38.40
<b>High-inflow (2000)</b>	627.5	21.3	33.89
<b>Low-inflow (1996)</b>	388.5	16.3	41.88

How the value of flexibility from hydropower, and the operation of hydropower plants are affected by the appearance of other flexibility providers (like flexibility from the building sector) will be further addressed in the ongoing work in the FlexBuild project.

## 8 Flexibility potential in the building stock: Results from a case study

*Marius Bagle, Karen B. Lindberg and Igor Sartori (SINTEF)*

BUTLER is a techno-economic optimisation tool applied to one single building. The model supports investments in heating technologies, storage technologies and power generating technologies. With its hourly time resolution, BUTLER accounts for detailed operational insights. In the following, we will present some results from a case study on a single building, using BUTLER and load profiles from PROFet as the basis, with the development of flexible sub models enabling an investigation into the flexibility potential of loads otherwise considered to be static, i.e., space heating, domestic hot water and electric vehicle charging. For a complete description of the sub models and the case study set-up, see Appendix F: Single building case study. The appendix also contains a detailed walkthrough of the results on the single building/apartment level, in the form of two unpublished papers, one on space heating flexibility and the other on EV-charging flexibility.

### 8.1 Results

Detailed results in Appendix F: Single building case study. All data presented and analysed here refer to an Apartment block of Regular envelope efficiency and with Panel Oven (PO), also named electric heater, as heating technology; a case that represents ca. 62% of the existing stock of apartments. Appendix F: Single building case study also analyses combinations of heat pumps and electric boilers, for buildings with waterborne heating system.

Three flexibility sources were activated one-by-one and together:

- Domestic Hot Water (DHW) tank: the tank is allowed to be overheated, thus shifting the energy use for DHW with respect to the baseline.
- Space Heating (SH): indoor temperature is allowed to fluctuate upwards, with respect to the baseline. In this way the thermal envelope of the building gets 'charged' and 'discharged' at a later time, thus shifting the energy use for space heating while safeguarding users' comfort (indoor temperature is not allowed to go below the baseline).
- Electric Vehicle (EV) charging: the charging pattern is allowed to change from the baseline, within each charging event. Available measurements from 10 well monitored EVs provided connection time and energy use per each charging event, so that these parameters are always respected, for each individual EV. Given that the apartment block consists of 24 dwellings, this corresponds to an EV penetration rate of 0.4 EV per households. This is above the present situation and may be taken as representative for a near future, around 2030.

The first two (thermal) options, come along with attached losses deriving from the upward lift of temperature to provide flexibility, while the EV option is – in this modelling – losses free.

The focus has been only on the electricity use, and flexibility was activated with two alternative goals:

3. Minimize operational costs for the user, incl. spot price and grid tariff, in the context of two different grid tariffs<sup>3</sup>:
  - c. Energy Pricing, with a fixed-term and an energy-term, named EP.
  - d. Peak Power Monthly, with a fixed-term, an energy-term and a peak power-term that varies each month, named PPM.
4. Pursue a flat profile of electricity use (minimize energy use while minimizing also variations in energy use), which is tariff independent since it is only based on physical quantities, named FLAT.

In the following, plots showing these different flexibility options in a conceptual manner will be presented.

---

<sup>3</sup> As provided by Elvia.

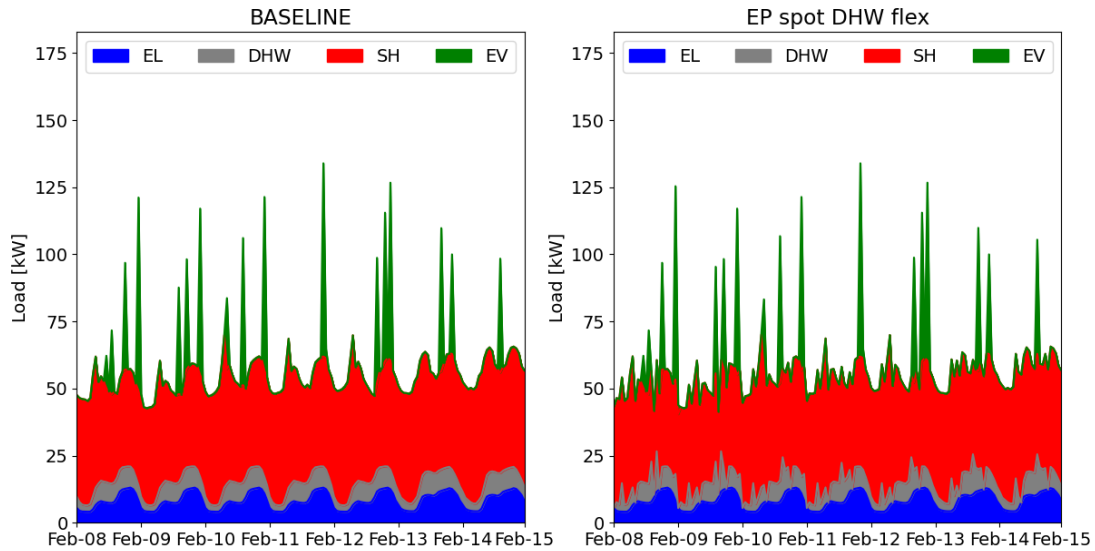

Figure 65. Domestic Hot Water (DHW) flexibility, with Energy pricing tariff.

Figure 65 shows the case with DHW flexibility conceptually, i.e., the representative temperature of a one-node tank is allowed to fluctuate between 50 and 60 degrees C. We see that the other loads, i.e. space heating (SH), electric vehicle (EV) and electric specific (EL), remain static. The most visible effect of the flexibility is a more "chopped" profile of the DHW, moving some heating to lower-priced hours, and some heating away from higher-priced hours.

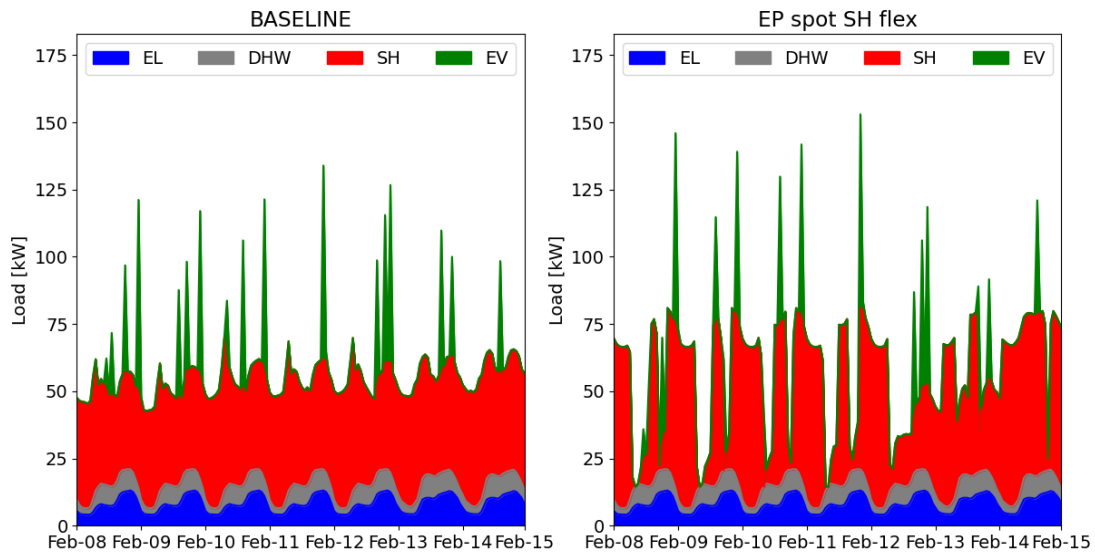

Figure 66. Space heating (SH) flexibility, with Energy pricing tariff.

Figure 66 shows the case in which SH flexibility is made available, i.e. the indoor temperature is allowed to *exceed* by max 2 °C (but not fall below) the baseline temperature (obtained from the PROFet profiles). We see that this produces a more significant effect on the operation of the whole building (which is natural, given that space heating is the largest load). Again, the overall effect can be described as making the load (the power applied to panel ovens in this case) more chopped. In some timesteps (in the morning on high-price days), the heating is even curtailed completely, which requires some overheating during the night. Whether this is acceptable from a user standpoint is outside the scope of this case study.

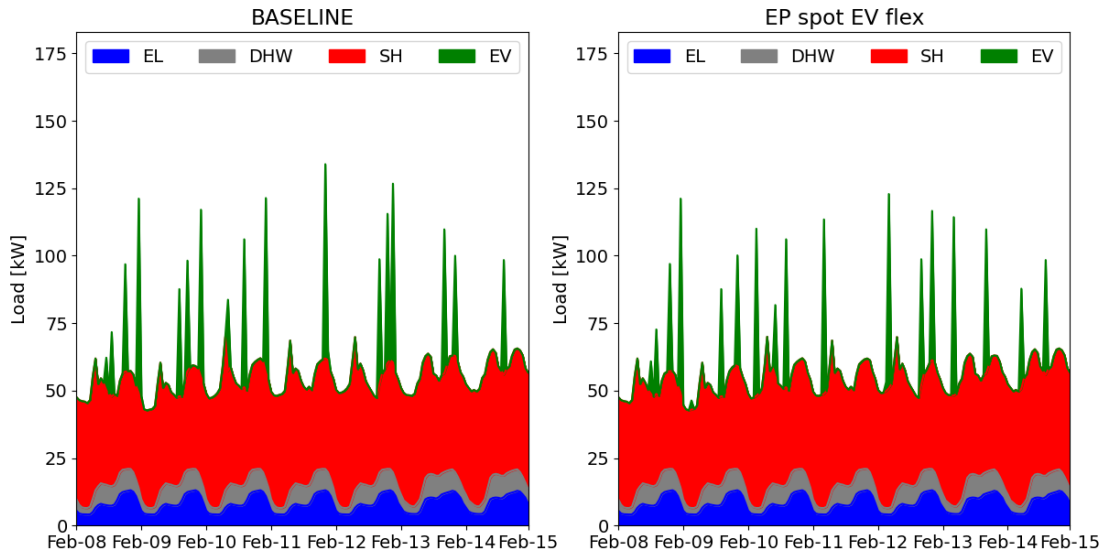

Figure 67. EV flexibility, with Energy pricing tariff.

Figure 67 shows the case with the EV charging being flexible. The model is formulated such that the actual plug-in and plug-out times of the vehicles have to be respected. Thus, we can investigate the maximum theoretical flexibility available from EV-charging. We see that the charging pattern mostly contains small shifts in the charging events, the characteristic pattern of the profiles does not change significantly.

All cases until here are with an Energy Pricing grid tariff (EP). Since the EP does not set any penalty for peak load, what happens is that as much as possible of any flexible load is shifted in cheap price hours (usually at night) and away from peak-price hours (usually in the early morning and late afternoon). The results is that the peak load, although shifted to cheap hours, may result even higher in the flexible case. This is especially the case for the flexible SH, given that it is the largest load, and the slow thermal inertia of the building allows to shift a considerable part of it. The SH load is shifted, also, into evening hours, thus overlapping more with the EV load (inflexible in Figure 66) and causing higher peak loads.

This inconvenience is correct for when introducing either a grid tariff with a peak power penalty (such as the PPM) or when pursuing the FLAT profile as a goal, as shown in the following figures.

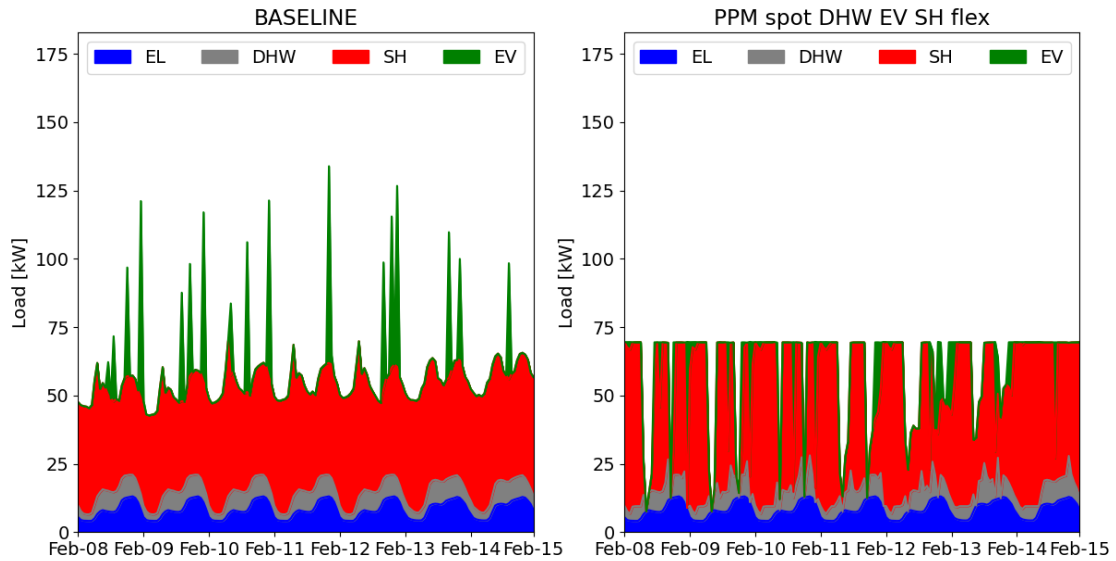

Figure 68. All flexibility sources, with Peak Power Monthly tariff (PPM)

Figure 68 shows the case with Peak Power Monthly grid tariff (PPM) and all flexibility options activated. We see that the loads are served in a manner which allow the peak to be reduced by a significant amount. With a bit of simplification, we can say that this is due to a more coordinated operation of building energy system: e.g., we reduce the power applied to SH a somewhat to charge the EVs and "charge" the hot water tank, and vice versa. Whichever load is the most constrained in a given timestep will be prioritized first. Since this is a deterministic case with perfect foresight and no model mismatch, we are able to obtain the maximum theoretical peak power reduction under the given assumptions on the building energy system (see Appendix F: Single building case study for full description and details).

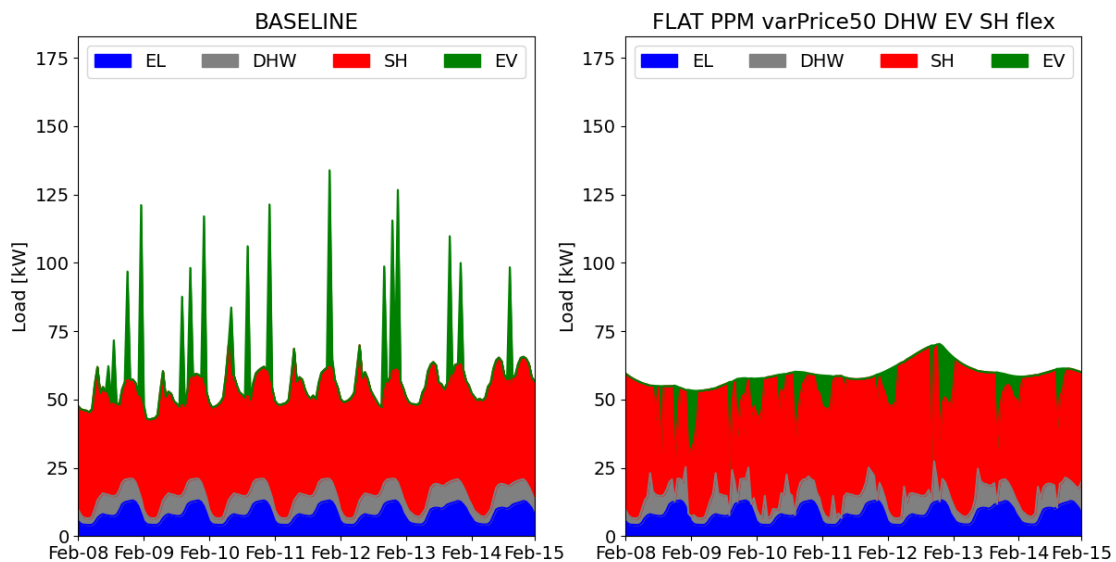

Figure 69. All flexibility sources, with FLAT target (tariff independent).

Figure 69 shows the case with all flexibility options enabled and a flattening target on the imported electricity. The peak load reduction is of the same order of magnitude as the previous case. The difference is in how this is achieved: compared to the previous case, the profiles are much more "evened out", as a natural consequence of the flattening target, which values inertia in the electricity import. Compared to the PPM tariff, the FLAT profile does not show any "deep valley" in the load, which might also be a desirable property of the load for a smooth operation of the energy system.

## 8.2 KPIs results

KPIs are given in terms of operational cost (for the user) and peak load, in relation to deviations from the Baseline, i.e., the typical energy demand from PROFet.

Figure 70 shows the annual operational costs of the apartment block considered in the case study (blue bars) for the flexibility options SH and DHW and the optimization targets EP and FLAT. The baseline is the leftmost bar in the figure, PO\_EP\_nf. From the figure, it can be seen that flexibility has a marginal effect only on the operational cost under the EP scheme, both in case of SH and DHW. This can be seen more clearly in Figure 71, which shows the difference from baseline to each case in percent. We see that SH gives an (annual) operational cost decrease of below 1%, while at the same time increasing the annual peak load by ~7%. The DHW flexibility yields no visible change in the operational cost, while it increases the peak load with ~1%. The option SH&DHW, i.e., both together, yields a cost decrease somewhat higher than SH. However, it is still very marginal. The peak load increase is ~10%.

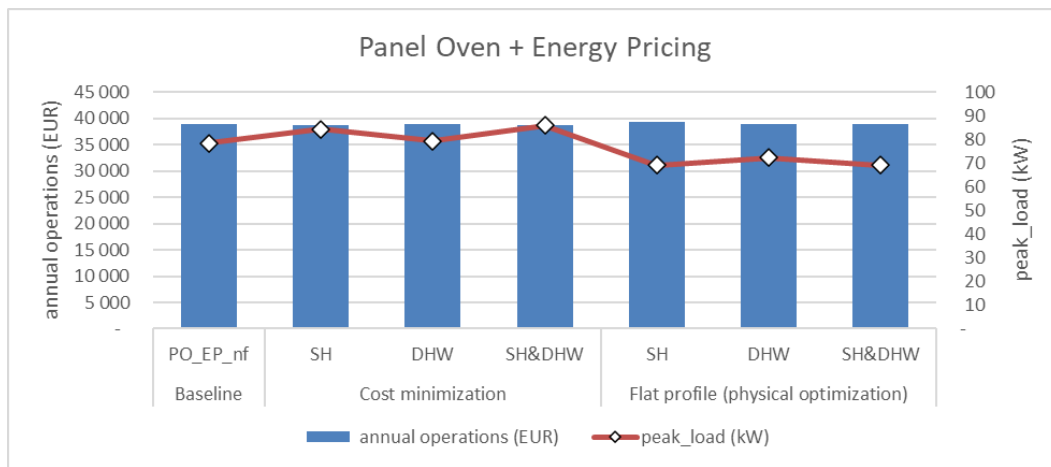

Figure 70. Annual operational costs, peak load with different flexibility options, energy pricing (wo/EV)

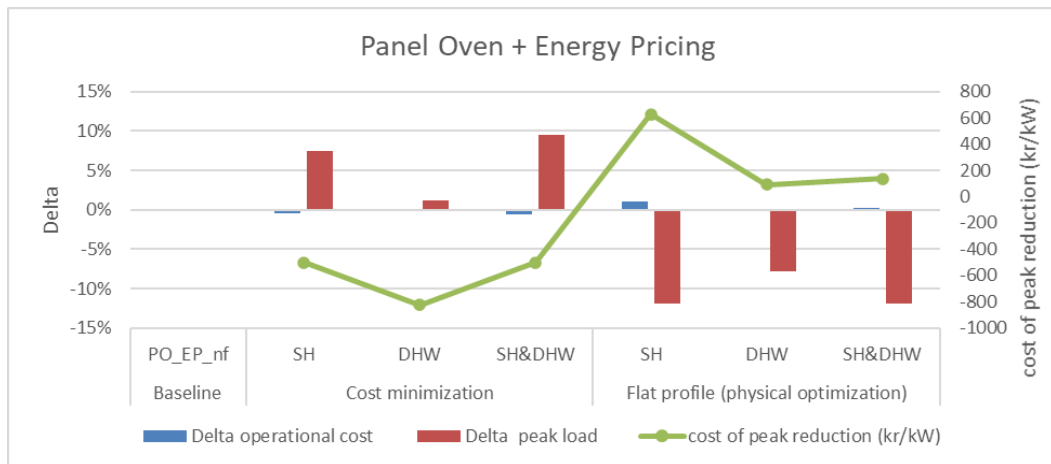

Figure 71. Delta cost, peak load with different flexibility options, energy pricing (wo/EV)

The optimization target FLAT yields different results. From Figure 71, it can be seen that the flexibility options SH and DHW enable a 12% and 7% annual peak load reduction at only a slightly increased cost (below 1% in the case of SH). The green line shows the "cost of peak reduction", i.e. the price the end-user pays for reducing her peak load per kW.

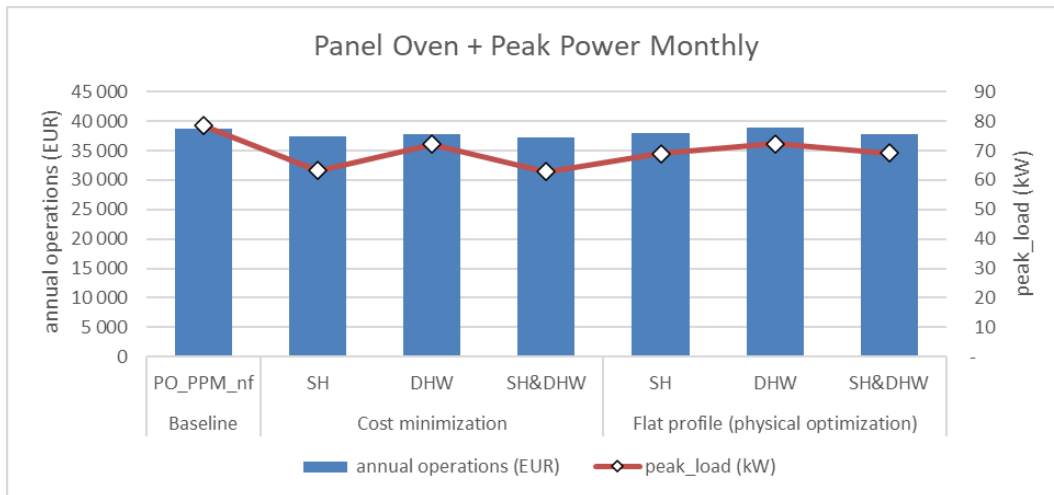

Figure 72. Annual operational costs with different flexibility options, peak power monthly (wo/EV)

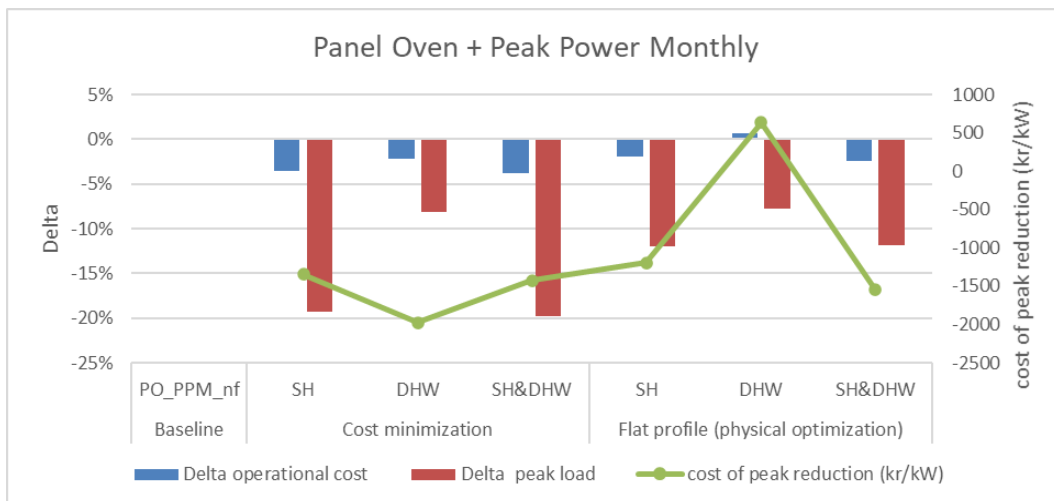

Figure 73. Annual peak load with different flexibility options, peak power monthly (wo/EV)

Figure 72 and Figure 73 show the costs and peak loads under the peak power monthly grid tariff scheme. Under this scheme, a large portion of the grid tariff is determined by the maximum power (in reality, power averaged over an hour) outtake during the month. In other words, there is an incentive to reduce the peak load in the cost minimization target. We see that this has a significant effect on the response of the building, as the peak load is reduced by almost 20% in the case of SH flexibility, along with a cost decrease of ~3.5%. The DHW flexibility gives a peak load decrease of ~8%, and a cost decrease of ~2%. With both flexibility options available, only marginal added value can be extracted from the DHW flexibility compared to SH, with a peak load decrease of 20% and a cost decrease of 4%.

For the FLAT target, we see the exact same peak load reduction as in the previous case. This is to be expected, since the objective function/optimization target is exactly the same, the only difference being how the grid tariff is calculated. With this grid tariff, the FLAT target gives a cost decrease in 2 out of 3 cases. However, both the peak load and cost decrease is markedly smaller than the cost minimization.



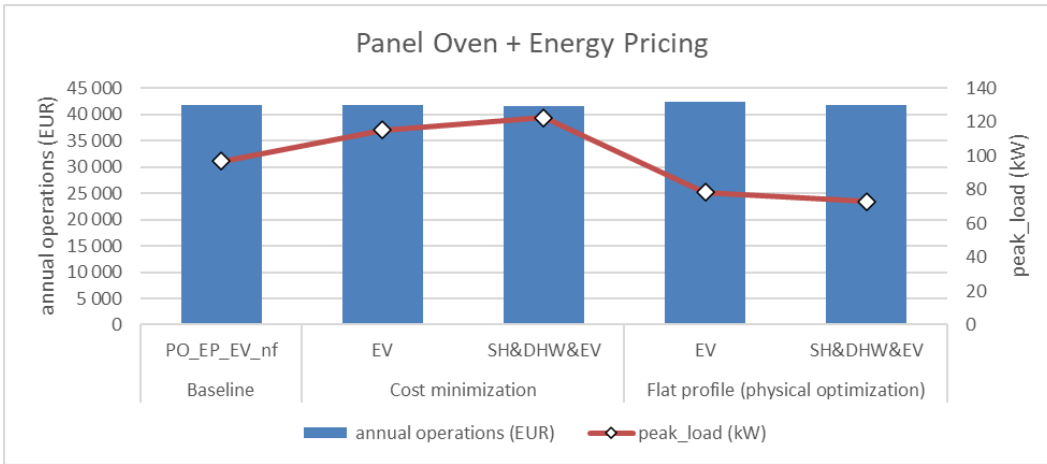

Figure 74. Annual operational costs with different flexibility options, energy pricing (w/EV)

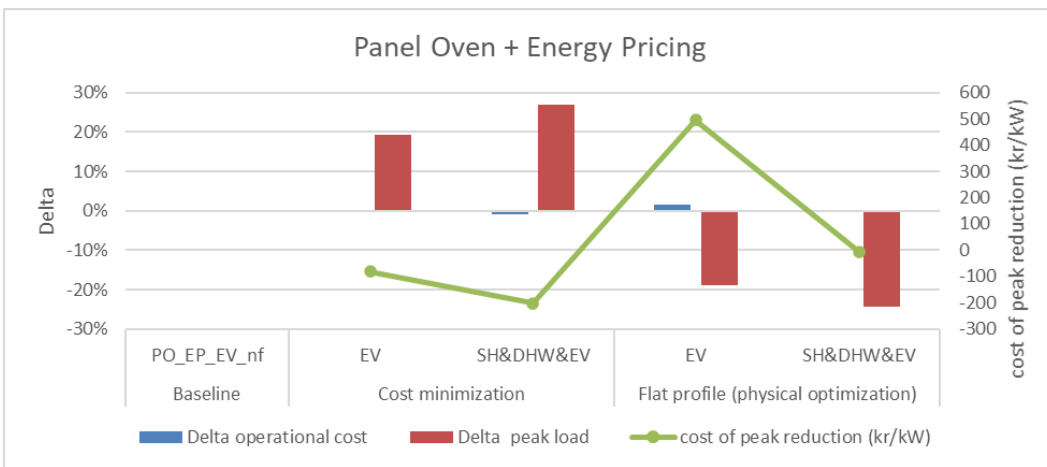

Figure 75. Annual peak load with different flexibility options, energy pricing (w/EV)

Figure 74 and Figure 75 show the costs and peak load with two further flexibility options, EV and SH&DHW&EV, with the former denoting the availability of all options. Note that the baseline in this case is different, since the static load of 10 EVs is added to it. From the figures, it can be seen that with the EP target, the peak load increases with 20% while having a negligible effect on the operational cost. This indicates a very high sensitivity to small price differences. Furthermore, it indicates that a significant amount of charging is moved to simultaneous and "slightly more optimal" hours (i.e. nighttime). For the case of all options (SH&DHW&EV), we see that the peak load is increased with ~28% with a cost decrease of less than 1%. In both of these cases, we see that "reward" for peak reduction is modest, at 150-200 kr/kW.

For the FLAT target with EV flex, the peak reduction is 20%, with a modest cost increase of below 1%. For the case of SH&DHW&EV, the peak reduction is ~24% with no visible change in cost. Again, the physical optimization is able to reverse the situation as compared to the EP cost minimization scheme.

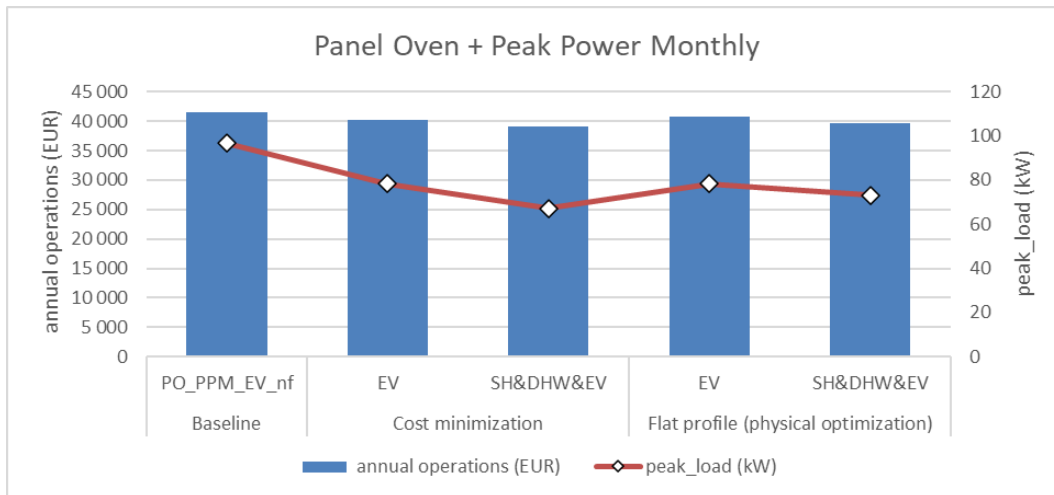

Figure 76. Annual operational costs with different flexibility options, peak power monthly (w/EV)

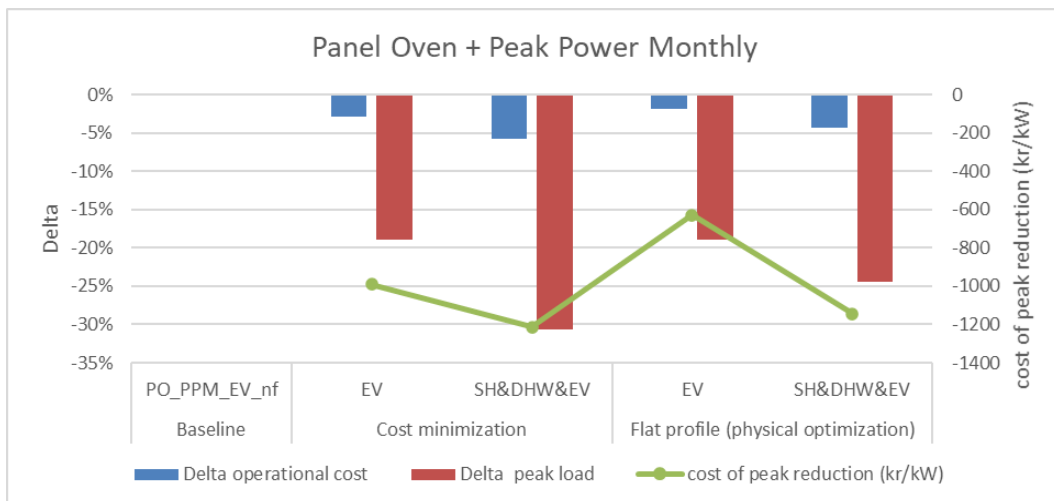

Figure 77. Annual peak load with different flexibility options, peak power monthly (wo/EV)

Figure 76 and Figure 77 show the peak loads and costs of the EV and SH&DHW&EV cases under the PPM grid tariff scheme. We have the same situation as in the cases of SH/DHW, i.e., that it is possible to achieve both a reduced cost (~5.5% in the best case, SH&DHW&DHW, cost min.) and a reduced annual peak load (~30%, same case). A 30% annual peak load reduction is a very large number; it must be kept in mind that this assumes both perfect foresight idealized (no model mismatch) optimal control and a penetration of 0.4 EVs per apartment. Again, note that the physical optimization FLAT yields worse results than the PPM + cost minimization optimization.

### Electricity load duration curves

To see the effect of the different flexibility options on the most energy-consuming hours of the year (we have arbitrarily chosen 500 here), it is possible to look at the duration curves of the total electric load. For ease of comparison to buildings with other characteristics than the one employed in the case study, we have normalized this down to kWh/h/m<sup>2</sup>.

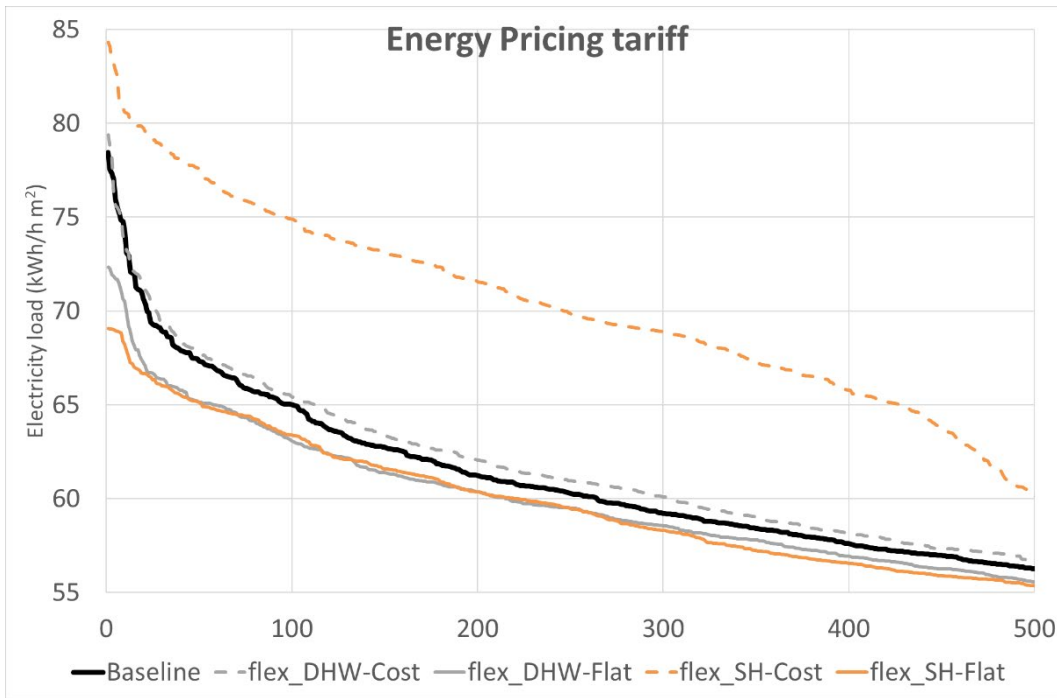

Figure 78. Duration curve SH, DHW, energy pricing.

Figure 78 shows the duration curve for the SH and DHW cases. It can be seen that flex\_SH-Cost, the load in the 500 hours shown is much higher than for the other cases. This can be explained easily by the fact that the hours are not the same across cases, for the flex\_SH-Cost case, the hours shown will tend to have a lower price than the hours for the baseline-case. With this "fat tail" of the flex\_SH-Cost case, we can expect that it has a thinner tail than the other cases in the remaining hours of the year. We see that the case "flex\_DHW-Cost" has a duration curve similar to the baseline. As for the cases with target FLAT (two bottom lines), they too show similar behaviour, with the most significant difference being the highest-load hours, where the SH case shows more peak reduction.

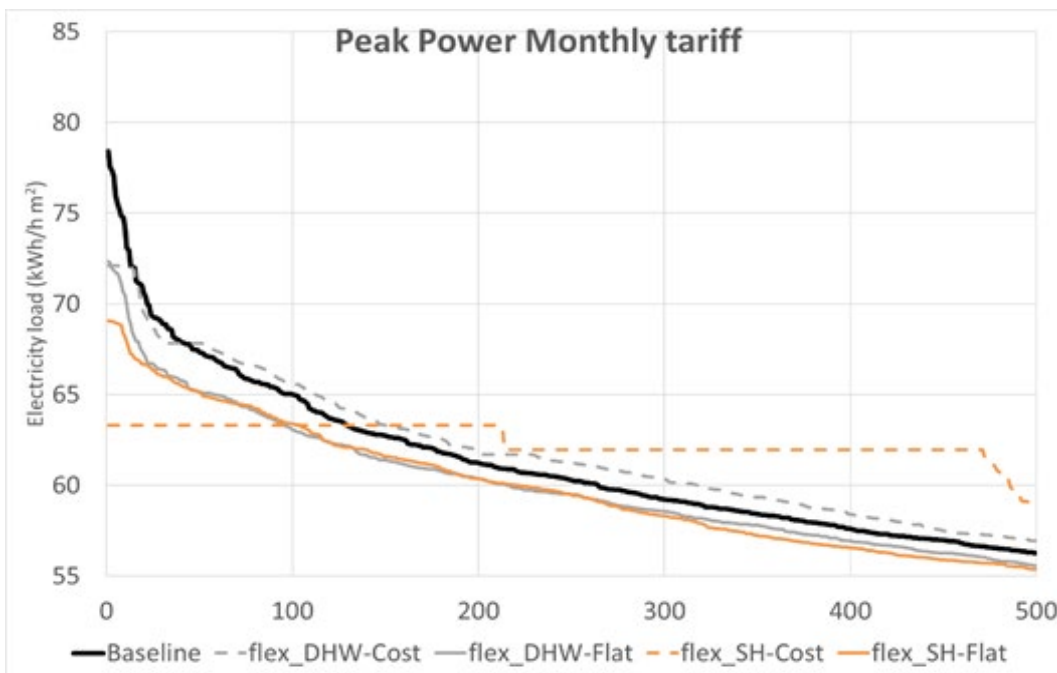

Figure 79. Duration curve SH, DHW, peak power.

Figure 79 shows the duration curve for the SH and DHW flexibility options under the PPM grid tariff scheme. We see immediately that the situation is reversed from the previous case, with the peak load decrease of flex\_SH-Cost being the most significant. The peak power limits chosen by the optimizer can readily be seen as the steps in the curve: for the most demanding month, the limit is selected to  $\sim 63$  kWh/h/m<sup>2</sup>, whereas for the next-most demanding month, it is  $\sim 1.5$  kWh/h/m<sup>2</sup> lower. No such "flat steps" can be seen for the case "flex\_DHW-Cost", which indicates that the HWT is not able to curtail the peak load to the same degree as the flexible space heating. The cases with FLAT target have the exact duration curves as in the previous plots.

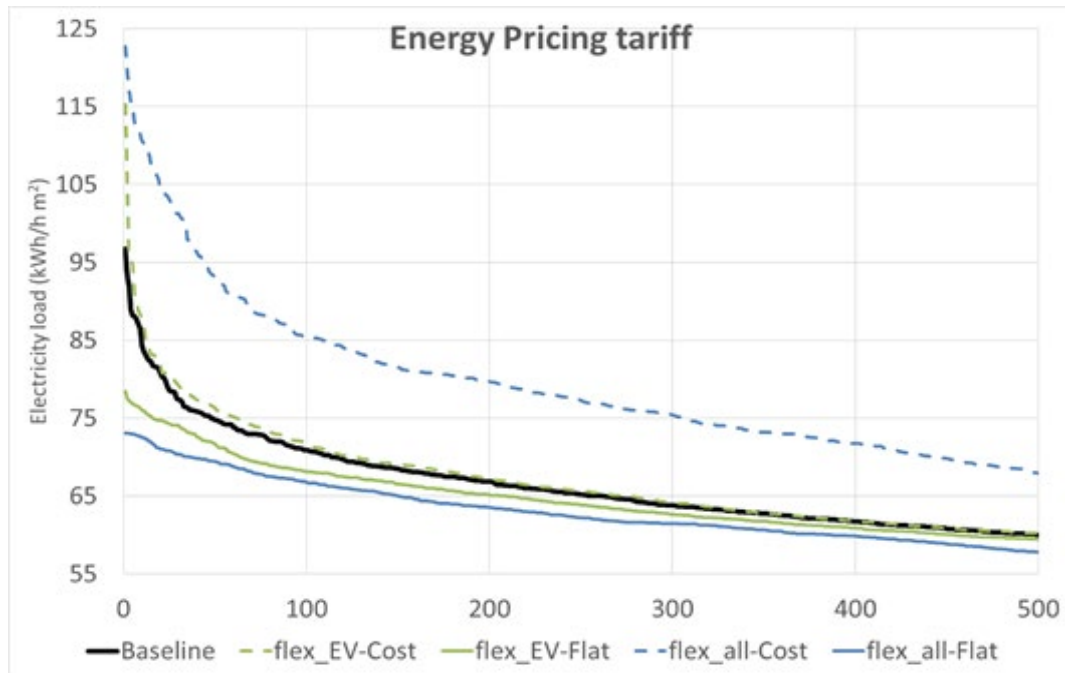

Figure 80. Duration curve EV, all, energy pricing.

Figure 80 shows the duration curve for the cases EV and SH&DHW&EV under the EP grid tariff scheme. It can be seen that most significant difference between the baseline and flex\_EV-Cost is made up by only a select few hours (high-demand), to which a high charging load is moved for the cost minimization case. However, for the other timesteps shown, it is natural to expect that the hours shown for the baseline and flex\_EV-Cost do not align perfectly, as the charging tends to get shifted a lot with small price differences with the setup we have. For the case flex\_all-Cost, we see that the features of the case just discussed and the case flex\_SH-Cost are combined, with a high peak load in addition to "fat tail". Again, we expect this duration curve to "rebound" in the form of a thinner tail in the hours not shown in this plot.

The FLAT-cases show the same tendency as before, with a significant reduction in the annual peak load at a small cost for the end-user.

Figure 81 shows the duration curve for the EV and SH&DHW&EV options under the PPM grid tariff scheme. Here, a universal tendency of annual peak load reduction is visible. As we have seen before, the largest reduction in terms of percent is found the flex\_all-Cost, with an annual peak load reduction of about 30%. The step-wise tracking of the limit can be seen here as well, with the limit for the most demanding month being  $\sim 67$  kWh/h/m<sup>2</sup>,  $\sim 65$  for the next most. The added value of additional flexibility options in addition to EV seems to be significant, as an additional peak load decrease of about 11 kWh/h/m<sup>2</sup> can be extracted from this (mainly by adding SH).

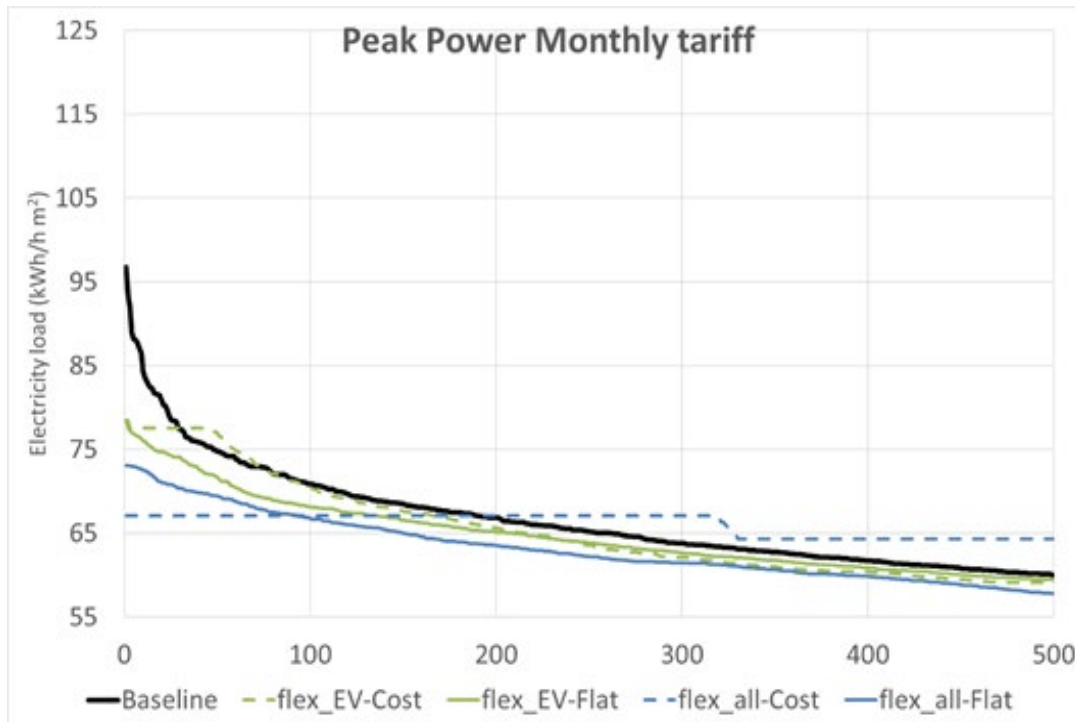

Figure 81. Duration curve EV, all, peak power.

### 8.3 Results at aggregated level

It was also possible to scale up the results of the case study to the aggregated level of the market area NO1 (Oslo climate), although only for the activation of Space heating and DHW. The available pool of data for EVs was not large enough to guarantee representativeness on a large scale. Due to the known phenomenon of decreasing coincidence factor with increasing number of users (= not everyone charges the car at the same time), it is reasonable to expect that on an aggregated scale the impact of EVs may be somewhat less marked than at the scale of a single building. The overall impact is obviously also affected by the amount of EV considered, that in the given case was of 0.4 EV per household, which would correspond to ca. 40% of the entire private car fleet (considering an approximate figure of 1 car per household, in average).

Figure 82 shows the scaled up total electric load for regular apartments in the market area NO1 for a selected week in December. We see that the space heating flexibility option has the largest impact on the total load; both in cases where the variability increases (Min.Cost + EP), the cases where value is placed on staying below a certain limit (Min. Cost + PPM) and when load flattening is desired.

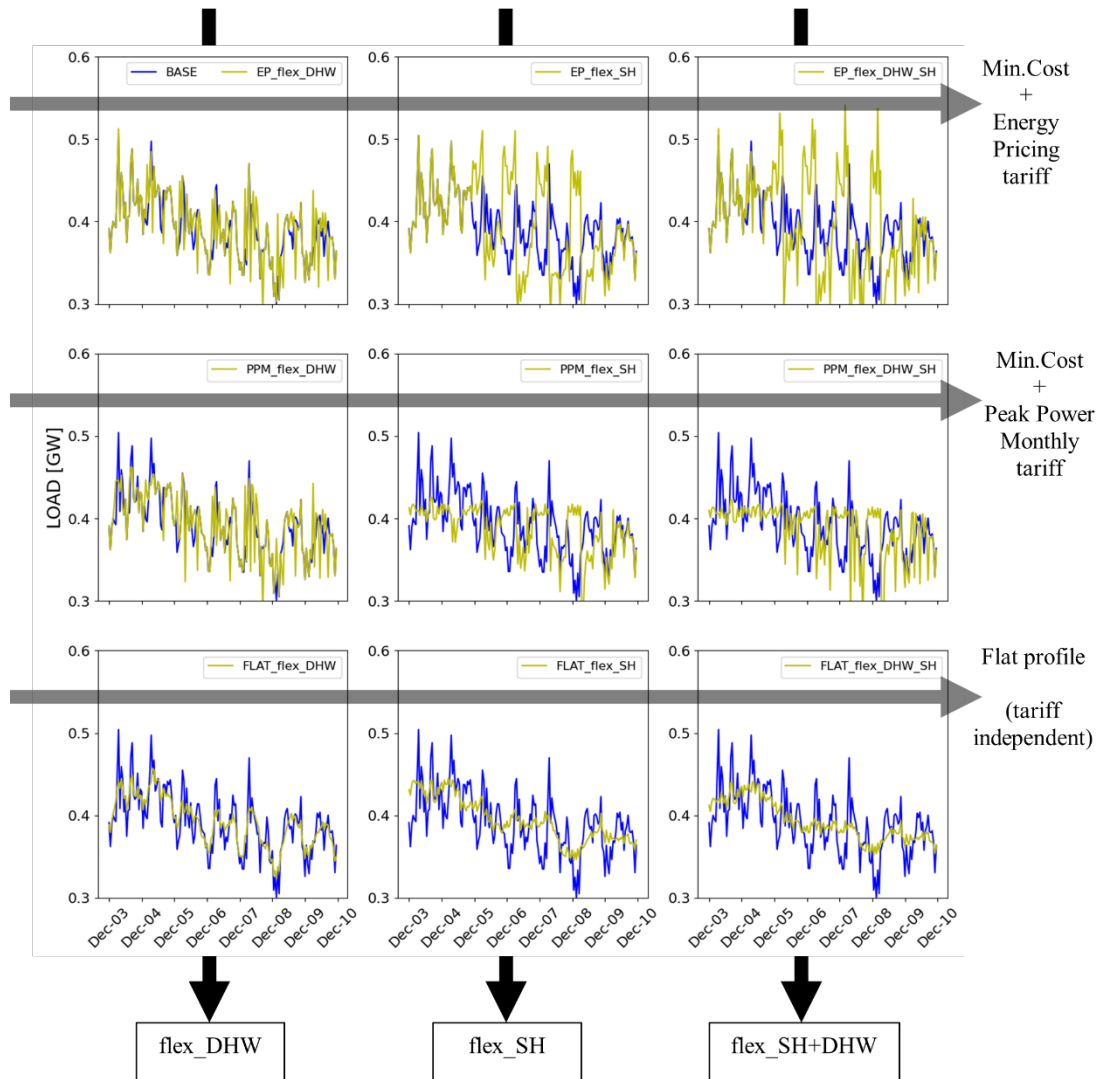

Figure 82. Aggregated results, Apt NO1

#### 8.4 Further work

Further work on the modelling of building flexibility will mainly be concerned with setting up the sub models for stochastic modelling, which necessitates coordination with WP1. Selecting the characteristics of the scenarios as well as the number of scenarios is mainly a task of WP1, so that the work needed for setting up the sub models for stochastic modelling is limited. However, setting up sensible constraints for e.g., seasonal transitions in the flexibility sub models, as well as establishing a procedure for calibrating the baseline temperature for the case of space heating flexibility that is consistent with stochastic modelling.

Setting up a two-way soft linking with TIMES is another important point of further work. This will mainly entail agreeing on the format for data exchange between the two models: total (shifted) end-use of electricity that shall go from BUTLER to TIMES, while energy prices shall go from TIMES to BUTLER. An important point that needs to be clarified is the length of the scenarios and how this impacts the data exchange: with BUTLER preferably working on a weekly level, in order to keep a relatively high level of detail in the modelling of flexibility, with TIMES working with representative days due to the large computational burden of having weeks (?). If the scenario lengths of the two models differ, how can representative days be synthesized from weeks BUTLER, and vice versa in TIMES?

Another point in need of further work is the future technology costs (2030, 2040, 2050) and costs of items such as grid tariffs. This will be coordinated and carried out in cooperation with IFE and is already in progress.

## 9 Conclusions

The first conclusions we can draw from the second year of the Flexbuild project are derived from inputs harmonization. This work has proven rather extensive and comprehensive, perhaps beyond initial expectations; in other words, it has taken longer than expected. But the results have been worth the effort.

In the first place, modelling of the **building stock** reveals how it **changes slowly in all Storylines**. It should be stated that none of the Storylines is meant to represent a sort of maximum energy conservation potential, although the Climate panic storyline does adopt some radical measures, but only after 2030. Rather, all Storylines are meant to be realistic alternatives, though following different narratives.

The amount of renovation, in particular, is taken from historical trends (about 1% per year) and is expected to slightly increase due to the ageing of the stock. However, not all renovation that occur have an impact on the energy efficiency of the building; some renovation work might be thorough, yet only useful to restore the original qualities that had been degraded over time. Other renovation work might be substantial economic wise, but only oriented to improve the interior quality (i.e., new bathroom, re-arranged floor plan), without any significant improvement of the building's thermal envelope. The available knowledge points at a very low rate of deep-renovation, that is a renovation that substantially improves the thermal properties of a building's envelope (such as walls and roof insulation, better windows, and airtightness), on the order of 0.2% per year. This historical value is increased in all Storylines, more or less, starting in 2020 or in 2030, except for the Petroleum nation.

It should also be noticed that, given the construct of the PROFet (energy demand load profiles estimator) model's inputs, only three levels of energy efficiency are possible in the modelling, namely: Regular, Efficient and Very efficient. All buildings built before 2010 are assumed to have Regular standard, reflecting an average energy consumption of the current building stock, and we assume that these buildings may only be upgraded to the Efficient level (similar to the TEK10 building code), never to the Very efficient level (similar to the Passive House standard), when deep-renovation occurs. This might sound like a conservative assumption; on the other hand, it is arguable if "gradual renovation" – as opposed to deep-renovation – of a building's envelope: a) does actually happen in the first place, and b) if it has any substantial effect on improving the building's efficiency beyond what is the average for the category, i.e., the Regular level<sup>4</sup>. All buildings built after 2010 are Efficient and are not assumed to undergo renovation until 2050. The Very efficient level (similar to the Passive House standard) is assumed to become the standard for new buildings, in 2020 or 2030, in all Storylines except the Petroleum nation.

This given, it turns out that in all Storylines **in 2050 the building stock will consist of ca. 70% of buildings already existing today, which will be responsible for ca. 80% of the energy demand**. It should be reminded that here we are talking of energy demand for specific services, such as space heating, domestic hot water and electric specific loads. The adoption of energy efficient technologies, such as heat pumps, affects the energy use (NO: energibruk) but does not affect the energy demand (NO: energibehov) of a building. The actual choice of which heating and other technologies to apply, is not a Storyline inputs but is an output of the modelling work. Specifically, in this second year, this has been an outcome of the IFE-TIMES-Norway model, based on the principle of cost optimality for the entire energy system.

However, before applying any Storyline assumption or running any simulation with the models, it was possible to **calibrate the building stock model for year 2020** by applying the known share of heating technologies (from statistics and other sources) to the various building categories, and thus validate the model against available energy use statistics. This calibration

---

<sup>4</sup> Replacement of windows in the oldest building cohorts has largely already happened, so this effect is already captured in the measurements used to define the Regular level.

has shown very good results, considering that **in the breakdown per building category** (Residential and Commercial) **and energy carrier the error is < 0.5 TWh/y**, on a total energy use of 80 TWh/y. This may be seen also as an indirect validation of the PROFet model that, although based on measurements, had not yet been compared with statistics at this level of aggregation, indeed the whole Norway's building stock.

Besides, **harmonization of inputs** led to a updated modelling of the expansion potential of **District Heating** in the IFE-TIMES-Norway energy system model. As described in Chapter 2, two variables concur to the adopted modelling:

3. On the supply side, not all the geographical area are, or can be served by district heating in the future. This, in turn, resulted in subdividing each electricity market area of Norway into three sub-areas, namely:
  - Large-scale district heating (*fjernvarme storskala*) sub-area, that is based on the SSB definition of 'cities' and a heat density > 100 GW2h/year.
  - Small-scale district heating (*småskala fjernvarme*) sub-area, that is based on the SSB definition of "tightly populated areas" and a heat density < 100 GWh/year.
  - No Thermal Network sub-area, that is based on the SSB definition of "sparsely populated areas" and a heat density too low to justify the development of thermal networks.
4. On the demand side, not all buildings have, or can have, a waterborne heating system. This, in turn, resulted in the following modelling assumptions and choices:
  - Small houses, it is assumed that they cannot connect to thermal networks. This was decided in dialogue with NFV and associated companies, because they are not interested in small houses for expanding their business. However, today there is a minor volume of district heating being delivered to small house.
  - Apartments, in the start year 2020, get a slightly overestimate, since they get allocated the total volume that today is used in residential buildings. This is done to keep overall consistency with the statistics on energy carriers use, while simplifying the modelling.
  - The percentage of existing buildings having waterborne heating is ca. 40% for Apartments and ca. 60% for Commercial buildings, based on available statistics on heating technologies and consumed district heating. In new buildings, this is assumed to become ca. 90%, for both Apartments and Commercial buildings.

The combination of these two variables led to the identification of the **potential for district heating expansion** in buildings towards 2030. This shows an overall doubling potential from today's 4.9 TWh to 10.3 TWh in 2030, where:

- Small-scale district heating has the largest potential for growth, from 1.8 TWh of today to 4.8 TWh in 2030 (almost a three-fold increase).
- Large-scale district heating can grow from 3.2 TWh of today up to 5.5 TWh in 2030.
- Commercial buildings demand for district heating can grow from 3.4 TWh of today up to 8.1 TWh in 2030, so parted:
  - Small-scale: from 1.1 TWh today to 3.7 TWh in 2030
  - Large-scale: from 2.2 TWh today to 4.4 TWh in 2030
- Apartment blocks demand for district heating can grow from 1.5 TWh of today up to 2.2 TWh in 2030, so parted:
  - Small-scale: from 0.7 TWh today to 1.0 TWh in 2030
  - Large-scale: from 0.9 TWh today to 1.3 TWh in 2030

In other words, geographic-wise the largest potential is on peripheral areas of cities or in smaller centres, where the heat density only requires small-scale district heating, and where



there is a higher concentration of Commercial buildings, with respect to Apartment blocks. Indeed, Apartment blocks are more concentrated in the inner part of large cities, where their demand is already nearly saturated by large-scale district heating.

The main conclusions that can be drawn from the **supply side models** are the following:

- EMPIRE model of the EU Power system:
  - As seen in the first year (from application in other projects) price variability is expected to be Storyline dependent, mainly related to CCS development in EU.
  - This year only the Energy nation storyline has been quantified, and since this does not foresee CCS development in the EU, the price variability is relatively high.
  
- IFE-TIMES-Norway model of the Norwegian energy system:
  - Electricity use and peak load in the building sector in 2050 are lower than in 2020 due to renovations and higher penetration of heat pumps and PV.
  - **End-use flexibility** has a positive value for the energy system, **reducing peak demand** and **favouring integration of building applied PV**.
  
- EMPS model of the hydropower system in Norway:
  - considers the supply side flexibility value as the difference in revenues (cost for the consumers) per unit of energy produced in regulated and run-off hydro-power plants, showing a difference of ca. +1 EUR/MWh (10 NOK/MWh) for the regulated plant.

On the **demand side**, a full modelling of the building stock has been made using the PROFet model, as discussed. However, the PROFet model only gives the typical energy demand, and does not allow for studying the end-use flexibility. This modelling capacity is under development in a stepwise process, benefitting also of work done outside of the Flexbuild project. The model that allows to consider the operational flexibility of energy demand is named FLEXor (FLEXible operation) while the final goal is the BUTLER model (BUilding's opTimaL Energy design and opERation) that include also a robust investment choice, based on several stochastic scenarios of the operational phase.

A **case study** has been performed on a single building, representative of a **typical Apartment** in the Regular efficiency level and with panel ovens as heating technology (62% of the stock). Here it was possible to study the **effect of different flexibility sources** by activating them one at a time, as well as together, and see how this would deviate the energy demand from the PROFet baseline:

- Domestic Hot Water (DHW) tank: the tank is allowed to be overheated, thus shifting the energy use for DHW with respect to the baseline.
- Space Heating (SH): indoor temperature is allowed to fluctuate upwards, with respect to the baseline. In this way the thermal envelope of the building gets 'charged' and 'discharged' at a later time, thus shifting the energy use for space heating while safeguarding users' comfort (indoor temperature is not allowed to go below the baseline).
- Electric Vehicle (EV) charging: the charging pattern is allowed to change from the baseline, within each charging event. Available measurements from several well monitored EVs provided connection time and energy use per each charging event, so that these parameters are always respected, for each individual EV.

The first two (thermal) options, come along with attached losses deriving from the upward lift of temperature to provide flexibility, while the EV option is – in this modelling – losses free.

The focus has been only on the electricity use, and flexibility was activated with two alternative goals:

5. Minimize operational costs for the user, incl. spot price and grid tariff, in the context of two different grid tariffs<sup>5</sup>:
  - e. Energy Pricing, with a fixed-term and an energy-term,
  - f. Peak Power Monthly, with a fixed-term, an energy-term and a peak power-term that varies each month.
6. Pursue a flat profile of electricity use (minimize energy use while minimizing also variations in energy use), which is tariff independent since it is only based on physical quantities.

The effects of flexibility were **measured in terms of cost and peak demand**, on a full year of simulate operation, leading to these conclusions:

- In the context of an Energy Pricing grid tariff:
  - When pursuing minimum cost, only marginal savings are achievable, in the order of -1%, and this happens at the cost of increasing the peak load by up to +27% (although this is shifted to the cheapest hours).
  - When pursuing a flat profile, on the contrary, it is **possible to reduce the peak load by up to -24% with no significant additional cost (~0%)**.

In both cases, the marginal cost variation is due to the low variability of the spot price (historical data for year 2012 were used).
- In the context of a Peak Power Monthly tariff:
  - In all cases it is possible to achieve both cost savings and peak load reduction, with the best results achieved when the goal is minimizing cost.
  - **The best case achieves -31% peak load with -6% cost savings** when all three flexibility source are activated together.
  - **Space heating alone can achieve -19% peak load with -4% cost.**

It was also possible to scale up the results of the case study to the aggregated level of the market area NO1 (Oslo climate), although only for the activation of Space heating and DHW. The available pool of data for EVs was not large enough to guarantee representativeness on a large scale. Due to the known phenomenon of decreasing coincidence factor with increasing number of users (= not everyone charges the car at the same time), it is reasonable to expect that on an aggregated scale the impact of EVs may be somewhat less marked than at the scale of a single building. The overall impact is obviously also affected by the amount of EV considered, that in the given case was of 0.4 EV per household, which would correspond to ca. 40% of the entire private car fleet (considering an approximate figure of 1 car per household, in average).

In summary, different models have given different **quantitative estimations of the flexibility potential** from different sources and under different conditions and have expressed the results **in different ways**.

From the energy system perspective, IFE-TIMES-Norway has coarsely quantified the value of three flexibility options for the energy system from 2020 to 2060. A first conclusion is that there is a significant Norwegian energy system value, in the range of numerous billion NOK, to expand the district heat production, facilitate for time-flexible heating of hot water and to use of stationary batteries in buildings. This implies that facilitating for investments in these three flexibility options can contribute to lower the cost of a future low-carbon energy system. A second conclusion is that this energy system value of these flexibility options is storyline dependent. Particularly, it is the value and investments in stationary batteries that is most storyline dependent. Further analysis will investigate what actors that are the winners and losers of introducing these flexibility opportunities options.

---

<sup>5</sup> As provided by Elvia.

From the demand side modelling on a representative single Apartment block with a penetration of 0.4 EV per household, considering the peak load reduction (in % with respect to a baseline), and depending on the applied grid tariff and optimization goal, the results show the following range and ranking of flexibility sources:

4. Electric Vehicles (-19%)
5. Space heating (-12 – -19%)
6. DHW tank (-8%)

The best results in terms of peak reduction, and cost minimization for the users alike, are obtained when pursuing the goal of minimizing cost with a Peak Power Monthly grid tariff. On the contrary, with an Energy Pricing grid tariff, minimization of cost harvest modest result while leading to substantial increase of the peak load (although shifted into hours of low electricity price). As a possible alternative, flexibility might be activated with another goal than cost minimization, that is the goal of obtaining an energy demand that is as flat as possible (without increasing losses too much, that is pursuing minimum energy use with minimum hour-by-hour variation). This 'flatness' goal is tariff independent because it only acts on physical variables. This shows to obtain good results in terms of peak load reduction (although less good than cost minimization with PPM tariff) while adding no substantial cost to the user (in the order of 1%).

## Appendix A: Storyline descriptions

### Petroleumsnasjonen Norge

Det er stor politisk vilje både i Norge og Europa til å håndtere klimakrisen. Både regulering og markeds mekanismer som EU ETS står sterkt. CCS-teknologien blir kommersiell i løpet av det neste tiåret. Det betyr at i 2050 er norsk olje og gass fortsatt etterspurt og vi har funnet store mengder ny gass. CO<sub>2</sub> er et handelsprodukt og CCU står sterkt. Hydrogen regnes som en av de store fleksibilitetskildene. Fokuset er på sentraliserte storskalaløsninger for energiproduksjon. Fornybar energiproduksjon øker kraftig, men i Norge hovedsakelig vindkraft og mest til havs.

Transportsektoren benyttet hovedsakelig hydrogen og batterielektrisk. Forbruket i husholdninger er omtrent som i dag eller økende. Energieffektivisering er økonomisk motivert. Norsk krafteksport er moderat, og det er mindre behov for vindkraft. Dette drives av markedet, og det er politisk aksept for at det i mange år er kraftunderskudd og netto import. I tillegg til industri CCS ser vi en økende elektrifisering av industri.

### Energinasjonen Norge

Det er stor politisk vilje både i Norge og Europa til å håndtere klimakrisen. Både regulering og markeds mekanismer som EU ETS står sterkt. Samfunnet elektrifiseres, siden CCS-teknologien aldri blir kommersiell. Det betyr og at i 2050 er norsk olje og gass helt borte fra markedene og petroleumssektoren er faset ut av norsk økonomi.

Norge satser på storstilt utbygging av fornybar energi, hovedsakelig offshore og onshore vind, men også solceller integrert i bygg. Solceller blir den vanlige taktekningen på nye bygg og for rehabilitering av tak. Energieffektivisering støttes ikke med subsidier, men gjennomføres dersom det er lønnsomt. Da fokuseres det på å frigjøre energi og effekt som kan eksporteres.

I tillegg til eksport gjør de økte energivolumene Norge til et attraktivt land for energiforedlende industri. Norge blir en stor eksportør av energivarer (varer med et stort energiinnhold). Økningen i el-etterspørsel kommer hovedsakelig fra energi.

Uten fossile drivstoff er transportbransjen basert på batterielektrisk, hydrogen og supplement fra biodrivstoff. Power-to-X teknologier får økt fokus og gir økt fleksibilitet i kraftsektoren. Andre fleksibilitetskilder er aktive konsumenter og fleksible bygg/nabolag.

Systemet har økt desentralisert energiproduksjon, men transmisjon benyttes til å forsyne systemet med fleksibilitet, inklusive utenlandskabler.

Sentralisert og desentralisert.

### Naturnasjonen Norge

Nasjonal identitet er i fokus, og vern av natur får økt oppslutning. Naturinngrep minimeres. Det skaper økt fokus på energieffektivisering, rehabilitering, sirkulær økonomi og annen ressursutnyttelse, for eksempel spillvarme.

Innenfor energisektoren fokuserer man på å redusere etterspørsel, og det er aksept for lavere økonomisk vekst. Utvikling og ny næring skapes i hovedsak i andre sektorer enn fornybar energiproduksjon. Fortetting og urbanisering leder til mer effektive systemer for transport og energiforsyning.

CCS kommersialiseres før 2030, og sentraliserte løsninger i lokalmiljøet eller byer spiller en stor rolle i energisikkerhet og energiforsyning. Hydrogenproduksjon med CCS og kraftproduksjon fra naturgass med CCS spiller en rolle i det europeiske kraftsystemet, og norsk økonomi avhenger av dette. Avfallsforbrenning og varmeproduksjon med CCS spiller en viktig rolle i omstillingen av storbyene.

Samtidig er det mindre aksept for transmisjon og store naturinngrep i Norge, med unntak av eksportkabler og offshore vind.

Personlige CO<sub>2</sub>-kvoter diskuteres, men politikerne foreslår å etablere markeder for disse, gjerne på europeisk nivå. EU Emission Trading System – Personal etableres for alle europeiske land.

### **Klimapanikknasjonen**

Norge, Europa og resten av verden bruker de neste 10 årene på å diskutere klimaløsninger. Det er bred enighet om at 1.5 gradersmålet vil nås ved hjelp av negative utslipp og CCS. I 2030 inntreffer to viktige og overraskende hendelser. Først smelter store deler av isen ved Antarktis på kort tid som en følge av endringer i havstrømmer. Samtidig ser vi brå og dramatiske klimaendringer som gjør deler av Europa om til ørken, mens andre deler får enorme økninger i nedbør eller forsvinner i havet. CCS-teknologien lykkes ikke i en skala som er nødvendig for å håndtere krisen.

Alle vestlige land innfører en klimaminister som er øverste beslutningsmyndighet over regjering og storting. Det fører til sterk statlig styring i perioden 2030–2050.

I den nye situasjonen går energietterspørselen dramatisk ned, men det samme gjør energi-produksjon siden kull og gass fases ut over natten. Nye atomkraftverk prosjekteres, men de kommer ikke på plass for 2050.

For sluttbrukere betyr dette rasjonering og at all sluttbrukerfleksibilitet tas ut. Vi ser en dramatisk økning av vind og sol på kort tid fra 2030. Transmisjon og energilagring blir viktig. Hydrogen spiller en stor rolle for å ta av overskuddsproduksjon.

I Europa fører energiunderskudd til nasjonalisering av energisystem og marked og fokus på egne land og ressurser. Sentral styring og regulering står sterkt. I Norge ser vi sammenslåing NVE + Stanet + Enova + Stakraft + Equinor. Fokuset er på maksimal ressursutnyttelse, men det kommer for sent. Alle tiltak gjennomføres: energieffektivisering, gjenvinning, spillvarme, fornybar, sirkulær økonomi, rasjonering.

## Appendix B: PROFet

PROFet (energy demand load profile estimator) is a tool that can estimate hourly load profiles for both thermal loads (space heating, SH, and domestic hot water, DHW) and electric specific loads (fans and pumps, lighting, plug loads), based on inputs on buildings' floor area and climatic variables. The statistical model is extracted from the measurement data in the database 'trEASURE', mostly from buildings connected to district heating. trEASURE is a measurement database where monitored energy data with hourly resolution from different buildings in Norway has been collected from more than 300 meters representing ca. 2.4 million m<sup>2</sup> of floor area, subdivided into 11 building categories, both residential and (mostly) non-residential buildings.

PROFet estimates the typical load profile of an area based solely on building area input and outdoor temperature (solar radiation and wind may be also considered in a future version). The model estimates a specific load profile based on the typical energy signature curves (ESC) for buildings in different groups (building categories and energy efficiency levels). The ESC Figure 1 below shows the relationship between the energy load heat load in an observed building and the outdoor temperature. For a typical building, the ESC for heating consists of two parts, divided by the change point temperature (CPT) – namely the temperature-dependent part and the temperature-independent part.

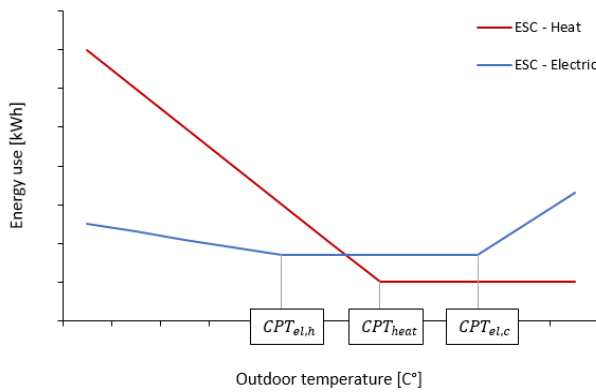

Figure 81. Energy Signature Curve (ESC) concept for heating and electric demand various building categories.

The space heat load  $y_{th}$  [kWh/m<sup>2</sup>] of a building type (building category and efficiency standard) at the time  $t$ , depends on the time of day ( $i$ ) dependent constants;  $\alpha_i^h$  and  $\gamma_i^h$ , the variable outdoor temperature,  $x_t$  and the 24-h moving average temperature ( $x_t^{h,TMA}$ ) when the outdoor temperature ( $x_t$ ) is lower than the change point temperature for space heating,  $CPT_{heat}$ , see Equation 1.

$$y_{th} = \begin{cases} \alpha_i^h + \beta_i^h x_t + \beta_i^{h,TMA} x_t^{h,TMA} + \gamma_i^h & \text{if } x_t < CPT_{heat} \\ \gamma_i^h & \text{if } x_t > CPT_{heat} \end{cases}$$

The electric load ESC in PROFet consists of three parts; 1) when the curve is temperature-dependent under a low CPT (which increases the demand for electricity use on cold and dark days) 2) a part which is temperature independent 3) and a part where the outdoor temperature is above a higher CPT, and where the energy use again becomes temperature dependent due to a cooling demand in the building.

The electric load  $y_{te}$  [kWh/m<sup>2</sup>] at the time  $t$ , depends on the time of day ( $i$ ) dependent constants;  $\alpha_i^h$  and  $\gamma_i^h$ , the variable outdoor temperature,  $x_t$ , and wheatear this temperature is above

the cooling threshold ( $CPT_{el,c}$ ) and below the heating threshold ( $CPT_{el,h}$ ). See Equation 2 below.

$$y_{te} = \begin{cases} \alpha_i^{e,h} + \beta_i^{e,h} x_t & \text{if } x_t < CPT_{el,h} \\ \gamma_i^h & \text{if } CPT_{el,h} < x_t < CPT_{el,c} \\ \alpha_i^{e,c} + \beta_i^{e,c} x_t & \text{if } x_t < CPT_{el,c} \end{cases}$$

Most residential buildings in Norway have not installed cooling systems, and so the typical electrical load ESC for houses and apartments will have flat curve when the temperature is above  $CPT_{el,c}$ .

The coefficients,  $\alpha$ ,  $\beta$ , and  $\gamma$  for each of the building categories, energy efficiency levels, and energy purposes have been created using panel data regression models (Bessler et al., 2014) on actual measurement data monitored buildings. In this paper, new sets of coefficients have been generated by the PROFet model concerning the initial work (Bessler, McCarl, Wu, & Alan Love, 2014).

### Development of PROFet

The development of PROFet model began with the following work:

- 1) Residential buildings: PhD thesis "Load modelling of buildings in mixed energy distribution systems" (L. Pedersen, 2007)
- 2) Service buildings: PhD thesis "Impact of ZEBs on the Power System – a study of load profiles, flexibility and system investments" (K.B. Lindberg, 2017)

Subsequently, the model has been improved and expanded.

Expansion: the above sources relied on a measurement database in the order of some dozen meters (Pedersen) or up to ca. one hundred (Lindberg), while the trEASURE database contains more than 300 meters, many of which with several years of data.

The following publications have introduced improvements:

- 3) K.B. Lindberg, S.J. Bakker, I. Sartori (2019) Modelling electric and heat load profiles of non-residential buildings for use in long-term aggregate load forecasts, Utilities Policy, Vol. 58: 63-88.

This article contains the major improvement of the statistical method, ensuring white noise in the residuals.

- 4) S.K. Lien, D. Ivanko and I. Sartori (2020) Domestic hot water decomposition from measured total heat in Norwegian buildings, BuildSim Nordic 2020 conference, 13-14 Oct., Oslo, Norway.

This paper describes the method used to decompose the DHW profile from the total heat metering. These method is used for all building categories except the residential ones (House and Apartment) and Hotels, for which typical DHW profiles were derived directly from sub-metering measurements available from the project Varmtvann 2030 (<https://www.sintef.no/projectweb/varmtvann/>, accessed 16/07/2021).

- 5) K.H. Andersen, S.K. Lien, H.T. Walnum, K.B. Lindberg and I. Sartori (2021) Further development and validation of the "PROFet" energy demand load profiles estimator, Building Simulation 2021 conference, 1-3 Sep., Bruges, BE.

This paper describes the method used to classify the buildings into the three efficiency levels, by comparing the ESC (Energy Signature Curve) of the measurements with that of reference simulation files. These were the simulation files that had been used for the definition of the TEK10 and Passive House energy efficiency standards. The three energy efficiency levels are:

- 'Regular' means average standard of buildings in the stock

- 'Efficient' means at about TEK10 standard (also representing an ambitious yet realistic target for energy efficient renovation)
- 'Very efficient' means at about Passive House standard

The paper performs also a validation of the PROFet model by comparing its results with out-of-sample data (data not included in the trEASURE database). Since PROFet is meant to represent the typical profiles of average buildings, the validation dataset should also consist of a high enough number of separate meters, so that its average may also be regarded as representative for that building category. Furthermore, while the panel regression model of PROFet allows to treat data from different locations and years, the validation dataset should all come from the same location and year for two reasons: first, to allow calculating the average, and second, to allow for a unique climatic input to PROFet. It follows that collection of out-of-sample data is quite demanding and for this reason the validation has been performed only for one building category: Apartments.

The results show that the PROFet estimated typical profile for the given location and climatic year is in good agreement with the out-of-sample datasets, and that the validation results are satisfactory as they are below the threshold values for the statistical indicators described in the ASHRAE guideline 14-2014 and in other literature on the subject.

An overview of the available input building area categories and the output load profiles in PROFet are given in Table 15.

Table 15. Available input to and output from PROFet.

Input categories		Output	Variations
Building categories	Energy efficiency levels	Energy purposes	Days (types)
House Apartment Office Shop Hotel Kindergarten School University Culture Sport Nursing home Hospital	Regular (existing) Efficient (existing / new) Very efficient (new)	EL SH DHW	Workday Weekday Holiday

Further specifications:

- The PROFet coefficients for the electric specific demand, EL, in the categories House and Apartment are still the same as from Pedersen (2007). This is because the new measurements collected in trEASURE for these categories came from buildings to which we had access only to the district heating meters.
- The PROFet coefficients for the category House are obtained indirectly starting from those of the category Apartment. This is because there were too few data sources in the trEASURE database to extrapolate them directly.

The indirect procedure was as follows for the space heating: first, the Apartment profiles were generated for the standard Oslo climate (as from NS3031), then it was scaled so that the combination of House and Apartment, weighted according to their share of the stock, would match existing statistics on the average annual energy demand of residential buildings, NVE (2012). This was done accounting for the effect of heat pumps, NVE (2016) and Enova (2012), since statistics are on energy use while PROFet profiles are on energy demand. For the DHW it was assumed that the average



household would have the same DHW demand regardless of the living unit, NVE (2012). Since the coefficients are given per m<sup>2</sup> (not per dwelling) they were scaled accordingly.

However, this still represents an improvement from the previous model (Pedersen, 2007) where all residential building were treated as a single category (residential), without distinction between small house and apartment blocks.

- c) The PROFet coefficients for the category House obtained as described above are somewhat overestimated. This is because statistical sources on energy use (used for scaling) allocate to households also the consumption from holiday houses (*hytte*), see references mentioned above and also SSB (2021).
- d) "Holidays" has been defined as follows in FLEXBUILD:
- **Holidays** are defined as work holidays and/or vacation days and are marked by the user in the PROFet tool. In FlexBuild one week in March (Easter) and 4 weeks in summer (summer holiday) have been marked.
  - **Religious holidays and national holidays** (such as easter and Pentecost) in the output from PROFet are assumed to be regular days (weekdays or weekend) as it differs from year to year when they occur. (However, in the data from trEASURE, they are treated as weekends, i.e., shops and offices are closed). So, if specified by the user, they shall be marked as 'weekend'.
  - The building categories "Shop" and "Culture and Sport" have different profiles for workdays, Saturdays and Sundays (which holds also for Holiday).

## References

- Andersen, K.H., Lien, S.K., Walnum, H.T., Lindberg K.B. and Sartori, I. (2021) Further development and validation of the "PROFet" energy demand load profiles estimator, Building Simulation 2021 conference, 1-3 Sep., Bruges, Belgium.
- Enova (2012) Potensial- og barrierestudie – Energieffektivisering av norske boliger.
- Lien, S.K., Ivanko, D. and Sartori, I. (2020) Domestic hot water decomposition from measured total heat in Norwegian buildings, BuildSim Nordic 2020 conference, 13-14 Oct., Oslo, Norway.
- Lindberg, K.B. (2017) Impact of ZEBs on the Power System – a study of load profiles, flexibility and system investments, *PhD thesis at NTNU*.
- Lindberg, K.B., Bakker, S.J. and Sartori, I. (2019) Modelling electric and heat load profiles of non-residential buildings for use in long-term aggregate load forecasts, *Utilities Policy*, Vol. 58: 63-88.
- NVE (2012) Energibruksrapporten 2012 – Energibruk i husholdningene.
- NVE (2016) Varmepumper i energisystemet – Status of muligheter.
- Pedersen, L. (2007) Load modelling of buildings in mixed energy distribution systems, *PhD thesis at NTNU*.
- SSB (2021) <https://www.ssb.no/statbank/table/11563>, accessed 8/2021.

## Appendix C: Building stock

### Stock development simulation and model inputs

For the period 2020–2050, the building stock is categorized according to the construction period, renovation status and energy efficiency level and distributed across the following two dimensions:

- existing building stock before 2020 and new construction after 2020. Part of the stock is renovated.
- energy efficiency level: Regular, Efficient and Very efficient

The building stock is distributed to the residential and service building types. The residential building types include House and Apartment block. Holiday homes are excluded from the building stock simulation and therefore not included in the building stock development shown in Figure 21-Figure 23. However, as explained in Appendix B: PROFet, the energy use in holiday homes is actually indirectly accounted for in the load profiles for the category House. Therefore, the simulated total energy use includes energy use in all buildings and can be compared with the statistics as done in Figure 38.

The service building types include Office, Nursing home, Shop, School and Other (including kindergarten, university, hospital, sports facilities, cultural buildings and light industry buildings), but grouped to one category called "service buildings" in this study.

The shares of the stock assumed to have each of the three energy efficiency levels are according to the principles summarized in Table 16 Distribution of the building stock to energy efficiency levels. Existing stock constructed before 2010 is either renovated or unchanged towards 2050. Unchanged floor area has the energy efficiency level "Regular" throughout the period. Renovated floor area is either still "Regular", as it is renovated without energy upgrading, or "Efficient", as it has been energy upgraded when renovated. Existing stock constructed since 2010 is assumed to be "Efficient". New construction after 2020 can either be "Efficient" or "Very efficient", according to storyline assumptions.

Table 16 Distribution of the building stock to energy efficiency levels

Existing		New	Renovated	
Constructed before 2010	Constructed 2010–2019	New 2020–2050	Renovated before 2020	Renovated 2020–2050
Regular	Efficient	Efficient or Very efficient, shares according to storyline assumptions	Regular	Regular or Efficient, shares according to storyline assumptions

Population statistics and medium scenario for the future projections are taken from Statistics Norway and presented in Table 16 (Statistics Norway, 2018). This population development is assumed in all storylines.

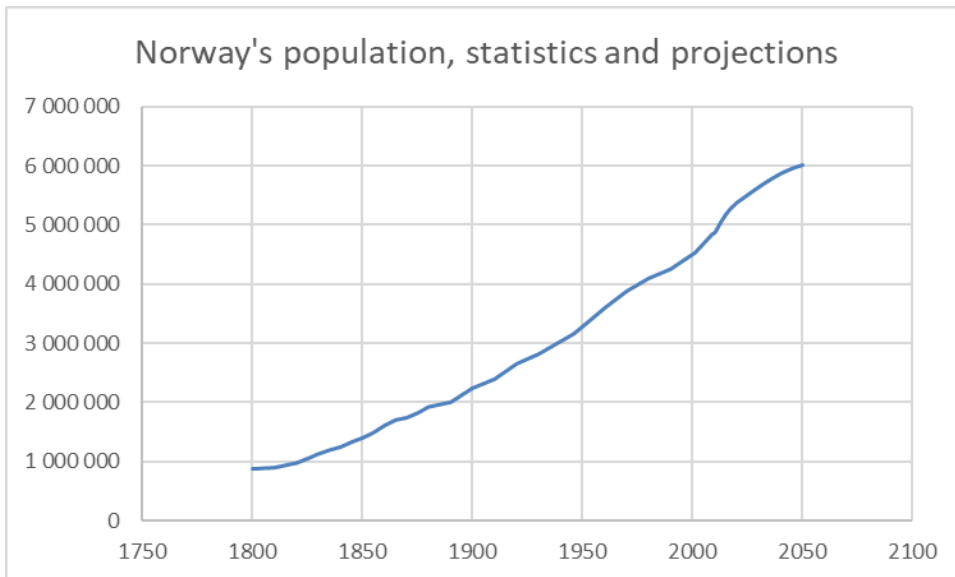

Figure 83. Norway's population 1800–2050. Statistics and projections. MMMM scenario. (Statistics Norway, 2018)

For the development of the stock of service buildings, the average floor area per person in various building types is based on the building stock analysis in Fjellheim et al. (Fjellheim et al., 2020). This is listed in Table 17 and kept constant throughout the period under study in all storylines.

Table 17. Average floor area per person in service buildings

Building type	Floor area per person (m <sup>2</sup> )
Office	5.7
Nursing home	1.0
Shop	6.6
School	3.0
Other	4.2
Total	20.6

A more detailed method is applied for the development of the residential building stock. This is based on a long series of publications, summarized by Sandberg (2017). Together with the population size, the average number of persons per dwelling is a core parameter for the development of the demand for floor area in the residential building stock. Figure 84 shows the development over time in average number of persons per dwelling, in small houses, apartment and the average of the total stock. Historical values are from statistics and future development based on assumptions. This development in average number of persons per dwelling in the two dwelling types is assumed in all scenarios, however the shares living in each of the types and subtypes vary between some of the scenarios. Single family houses and terraced houses are subtypes of Small house.

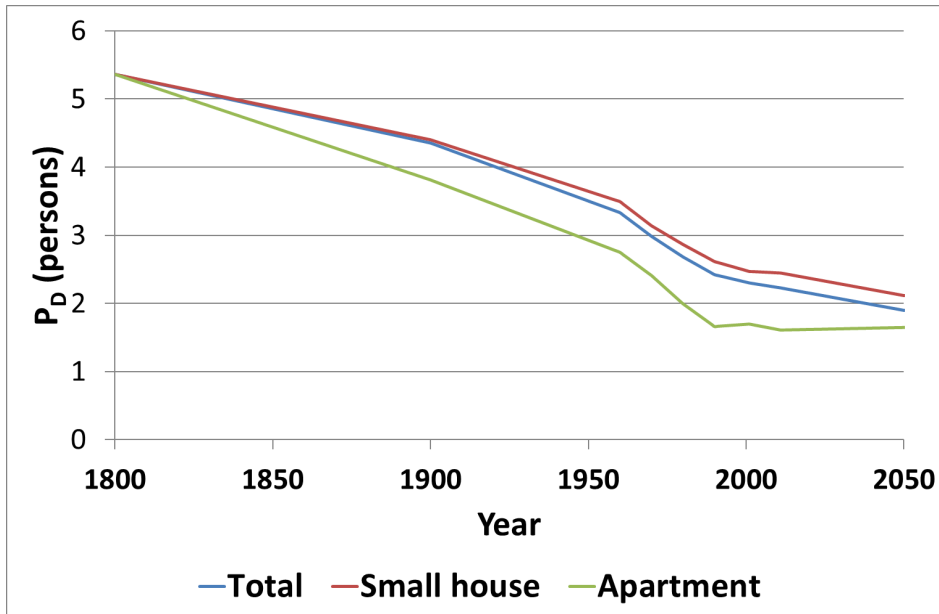

Figure 84. Persons per dwelling in the residential building stock.

The average floor area per dwelling is different in different segments of the residential building stock. The underlying model divides the stock into more segments than what are included in this study. This granularity is kept as it allows for more detailed information about the average floor area per dwelling in various segments. The segment definition and the average floor area per dwelling in the underlying analysis is presented in Table 18. Average floor area per dwelling for cohorts 0-6 are based on statistics. Average floor area per dwelling in cohort 7 and 8 is assumed to be equal to cohort 6.

Table 18. Segment definition and average floor area per dwelling applied in the dwelling stock model.

Cohort			Average floor area [m2]		
Cohort	From [Year]	To [Year]	Single	Terraced	Apartment
			family house	house	block
0	1800	1800	133	88	56
1	1801	1970	136	94	55
2	1971	1980	144	100	61
3	1981	1990	161	96	64
4	1991	2000	139	85	58
5	2001	2009	142	88	60
6	2010	2019	152	96	68
7	2020	2029	152	96	68
8	2030	2050	152	96	68

The average floor area per person in residential buildings is therefore not a direct input to the model. It is rather a result of the other inputs: number of persons per dwelling, average floor area per dwelling in various segments and assumptions on the shares of the population living in the various dwelling types. We vary the assumed shares living in the three dwelling types in some of the scenarios. Details about the input parameters applied here is, however, too detailed to discuss here, but the resulting parameter average floor area per person in residential buildings is listed in the table describing the scenario inputs and assumptions below.

Table 19 shows the various renovation rates resulting from different assumptions on renovation cycle in the model. Our baseline assumption is a renovation cycle of 50 years, which results in a renovation cycle of about 1%. In some of the storylines, the renovation cycle is decreased to increase the renovation activity in the system and hence the renovation rate. The resulting rates might however differ somewhat from the listed ones if we assume a change in the renovation cycle during the period, e.g.,  $R_c = 50$  until 2029 and then  $R_c = 40$  in the period 2030–2050, due to the overall effects on the dynamics of the stock.

Table 19. Renovation rates resulting from different renovation cycles in the dwelling stock model.

Renovation cycle $R_c$	Renovation rate (base year 2010)		
	2020	2030	2050
33		2.0 %	2.5 %
35		1.8 %	2.3 %
40	1.4 %	1.4 %	1.7 %
45	1.1 %	1.2 %	1.3 %
50	0.9 %	1.0 %	1.1 %
55	0.7 %	0.8 %	0.9 %
60	0.6 %	0.6 %	0.7 %

## Storyline inputs

When the four storylines are implemented in the dynamic building stock model, most inputs are kept equal. These are the input parameters that are described above. The inputs that are varied between the storylines are

- Shares of new construction being Efficient and Very efficient
- Renovation rate
- Share of renovated floor area being upgraded to Efficient
- For dwellings only: average floor area per person in residential buildings.

The rates describing the activities in the system (renovation; demolition and construction) are used to describe the variations between the storylines, even though these are not direct inputs to the model. Other factors are adjusted until they result in the levels of the rates we want in the various storylines. The renovation with energy efficiency rate is a result of the renovation rate and the assumed share of the renovated buildings being energy-upgraded while renovated. The average floor area per person in residential buildings is a result of scenario specific assumptions on future share of new construction being apartments compared to detached houses.

The storyline inputs are summarized in Table 20.

Table 20. Storyline inputs and assumptions.

Storyline assumptions	Energy nation		Petroleum nation		Nature nation		Climate panic	
	2020-2029	2030-2050	2020-2029	2030-2050	2020-2029	2030-2050	2020-2029	2030-2050
Share of new being Efficient	100.0 %	0.0 %	100.0 %	100.0 %	50.0 %	0.0 %	100.0 %	0.0 %
Share of new being Very efficient	0.0 %	100.0 %	0.0 %	0.0 %	50.0 %	100.0 %	0.0 %	100.0 %
Share of renovated being Regular after renovation	80.0 %	67.0 %	80.0 %	80.0 %	50.0 %	50.0 %	80.0 %	0.0 %
Share of renovated being Efficient after renovation	20.0 %	33.0 %	20.0 %	20.0 %	50.0 %	50.0 %	20.0 %	100.0 %
Renovation rate, service buildings	1.3 %	1.5 %	1.3 %	1.5 %	1.3 %	2.1 %	1.3 %	2.6 %
Renovation rate with energy-efficiency rate, service building	0.3 %	0.5 %	0.3 %	0.3 %	0.7 %	1.0 %	0.3 %	2.6 %
Demolition rate, service buildings	0.5 %	0.5 %	0.5 %	0.5 %	0.5 %	0.5 %	0.5 %	0.4 %
Construction rate, service buildings	1.1 %	0.9 %	1.1 %	0.9 %	1.1 %	0.9 %	1.1 %	0.8 %
Renovation rate, dwelling stock	0.9 %	0.9 %	0.9 %	0.9 %	0.9 %	1.5 %	0.9 %	2.0 %
Renovation with energy efficiency rate, dwelling stock	0.2 %	0.3 %	0.2 %	0.2 %	0.5 %	0.8 %	0.2 %	2.0 %
Demolition rate, dwelling stock	0.6 %	0.7 %	0.6 %	0.7 %	0.6 %	0.7 %	0.6 %	0.7 %
Construction rate, dwelling stock	1.4 %	1.4 %	1.4 %	1.4 %	1.4 %	1.4 %	1.4 %	1.4 %
Average floor area per person, dwelling stock (m <sup>2</sup> )	50.7	52.1	50.7	52.1	50.6	51.2	50.7	51.4

**The Petroleum nation** serves as the baseline scenario, with a continuation of current trends regarding energy efficiency level of the building stock. Energy efficiency is not pushed, but it is carried out whenever economically profitable. We implement this with assumptions new construction is "Efficient" throughout the period, and the share of renovated buildings being energy upgraded to "Efficient" is still 20%, while the remaining renovated floor area is still "Regular" after renovation. The extent of renovation and demolition is modelled with the same assumptions throughout the period, but the resulting rates vary somewhat as the stock composition varies over time. The construction rate is estimated by use of mass balance principles for each year. The resulting renovation rate is 1.3–1.5% for service buildings and 0.9% for the residential building stock ( $R_c = 50$ ). The renovation rate with energy-efficiency is 0.3% for the service building stock and 0.2% for the residential building stock, throughout the period. For the service building stock, the demolition rate is 0.5% and the construction rate is about 1%. For the residential building stock, the demolition rate is 0.6–0.7% and the construction rate is 1.4%. In the dwelling stock model, we assume a continuation of trends for the share of the population living in apartments, increasing from an average of 24% in 2020–2029 to 30% in 2030–2050. The share of new small houses being single family houses (with higher average floor area than terraced houses) is assumed to be 50% throughout the period. The development of the factors number of persons per dwelling, average floor area per dwelling and shares of various dwelling types results in an increase in average floor area per person in residential buildings from 50.7 m<sup>2</sup>/capita in the period 2020–2029 to 52.1 m<sup>2</sup>/capita in 2030–2050.

**The Energy nation** is mostly modelled in the same way as the Petroleum nation, but as there is a focus on making available energy and power that can be exported, we have assumed that 33% of the renovated buildings are "Efficient" after 2030. This result in the renovation rate with energy-efficiency increasing to 0.5% for the service building stock and 0.3% for the residential building stock in the period 2030–2050.

In the **Nature nation** storyline, we assume increased shares of Very efficient new construction and Efficient renovation already from 2020, with 50% of new construction being Very efficient and 50% of renovated buildings being Efficient. From 2030, we assume all new construction to be Very efficient. In addition, we assume the renovation rate to increase to 2.1% for service buildings and to 1.5% for residential buildings ( $R_c = 40$ ) in 2030–2050. Furthermore, to reflect more urbanization and higher shares of smaller dwellings, we assume the share of new small houses being single family houses to decrease to 40% in the period 2020–2029 and to 30% in 2030–2050 and the share of the population living in apartments to increase to 33% in 2030–2050. This results in somewhat smaller average floor area per person in residential buildings; 50.6 m<sup>2</sup>/capita in 2020–2029 and 52.2 in 2030–2050.

In the **Climate panic** storyline, we assume the same development as in the Petroleum nation and Energy nation storylines in the period 2020–2030. Thereafter, there are strong changes in many of the parameters, to reflect the situation the nation is in after the events in 2030. From 2030 onwards, all new construction is assumed to be Very efficient, and all renovated buildings are assumed to be Efficient. Furthermore, the renovation rate increases to 2.6% for service buildings and 2% ( $R_c = 35$ ) for residential buildings. This affects the resulting demotion and construction rates, which are then 0.4% and 0.8%, respectively. Finally, the share of the population living in apartments is increased to 33% and share of small houses being single family houses is decreased to 25% for the new small houses constructed in the period 2030–2050. This results in the average floor area per person in residential buildings decreasing to 51.4 m<sup>2</sup>/capita in the period 2030–2050, which is however somewhat higher than in the Nature nation storyline where the urbanization and larger shares of smaller dwellings started earlier.

The decreasing construction rate for the service buildings in all storylines is a result of the population projections that are showing a decreased population growth towards the end of the period under study.

## Appendix D: European power system

### Input data – Energy Nation

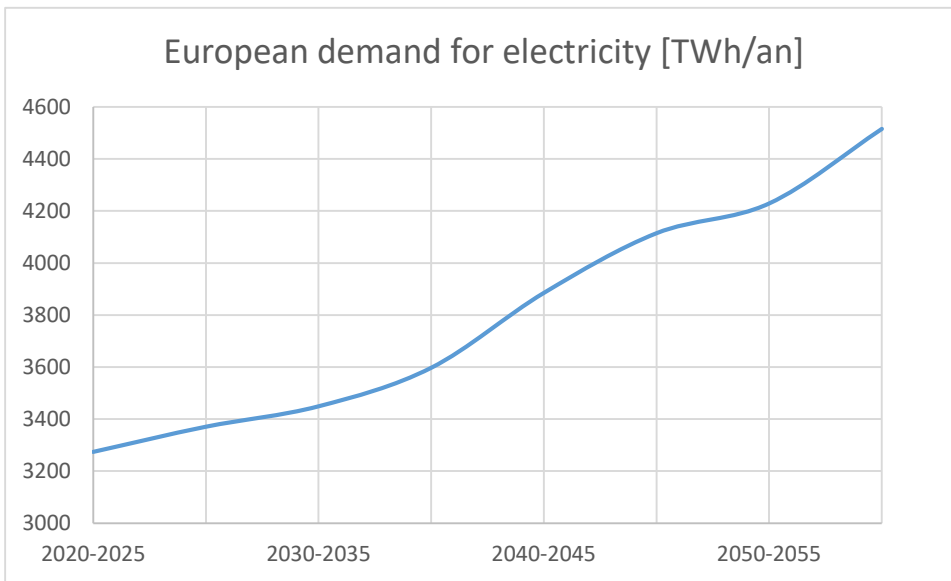

Figure 85. European electricity demand [TWh/year] input for the Energy Nation storyline

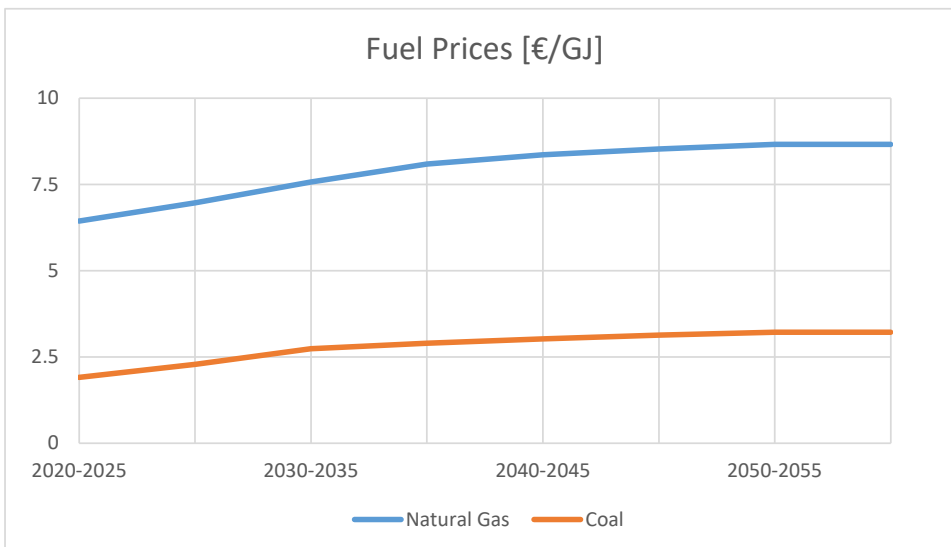

Figure 86. Coal and fuel prices development for the Energy Nation storyline

The price projections are taken from the European Commission reference scenario (2016). On the other hand, the European electricity demand is retrieved from the results provided from the European energy model [GENeSYS-MOD](#).

### Non-dispatchable production for Germany 2050

In the figures below, we reflect the average expected non-dispatchable production for each season in Germany in 2050. The difference of wind generation during the winter compared to the other seasons explains the lower prices during the night shown in Figure 87.

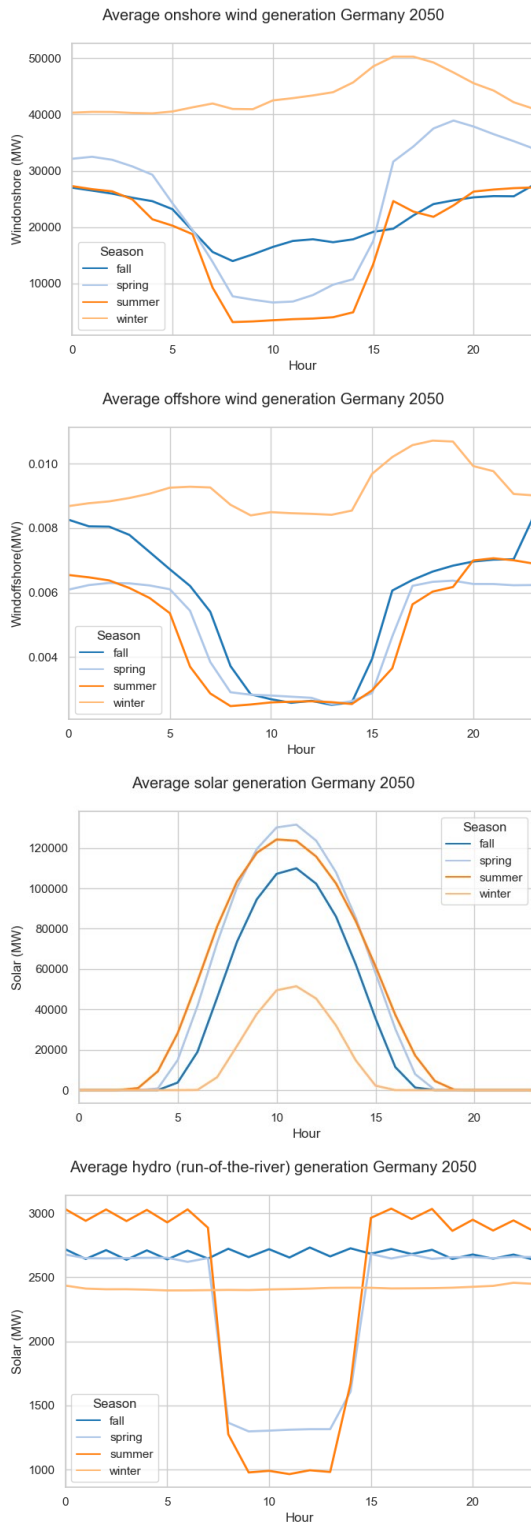

Figure 87. Average power production for non-dispatchable technologies in Germany 2050.



## Appendix E: Energy system model, IFE-TIMES-Norway

### IFE-TIMES-Norway model description

IFE-TIMES-Norway is an optimisation model of the Norwegian energy system that is generated by TIMES (The Integrated MARKAL-EFOM System) modelling framework. TIMES is a bottom-up framework that provides a detailed techno-economic description of resources, energy carriers, conversion technologies and energy demand. TIMES models minimize the total discounted cost of a given energy system to meet the demand for energy services for the regions over the period analysed. The total energy system cost includes investment costs in both supply and demand technologies, operation and maintenance costs, and income from electricity export to and costs of electricity import from countries outside Norway.

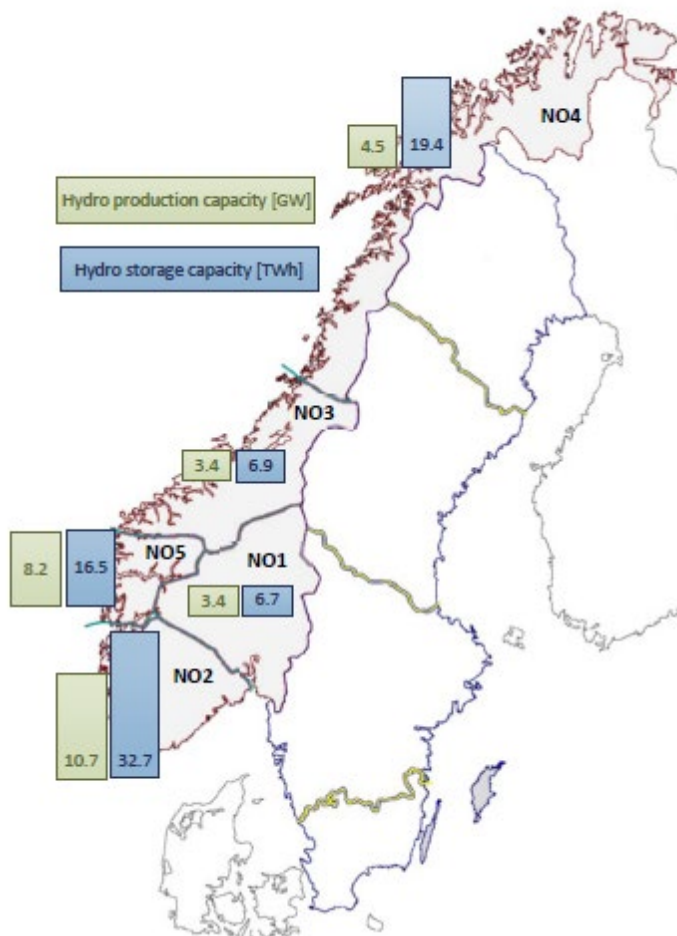

Figure 88. Map of Norway, divided by price area, indicating hydro generation and storage capacity.

IFE-TIMES-Norway is a technology-rich model of the Norwegian onshore energy system divided into five regions corresponding to the current electricity market spot price areas. An illustration of the price areas, with corresponding hydropower generation and reservoir capacity, are illustrated in Figure 88. The model provides operational and investment decisions from the starting year, 2018, towards 2050, with model periods for every fifth year from 2020 within this model horizon. To capture operational variations in energy generation and end-use, each model period is divided into 96 sub-annual time slices, where four seasons is represented by 24 chronological hours. The model has a detailed description of end-use of energy, and the demand for energy services is divided into numerous end-use categories within industry, buildings, and transport. Note that energy services refer to the services provided by consuming a fuel and not the fuel consumption itself. For example, the heating demand in buildings is an energy service while the fuel used to heat the building is not. Each energy service demand

category can be met by existing and new technologies using different energy carriers such as electricity, bio energy, district heating, hydrogen, and fossil fuels. Other input data include fuel prices; electricity prices in countries with transmission capacity to Norway; renewable resources; and technology characteristics such as costs, efficiencies, and lifetime and learning curves. More information about the model can be found in ref IFE-rapport documentation. The model is continuously developed and the main elements of relevance for the Flexbuild project is described in the following paragraphs.

## **Model improvements and updates in Year 2**

### **Building sector**

The building sector of IFE-TIMES-Norway is divided in residential single-family and multi-family houses and in non-residential/commercial buildings for each of the model regions. The buildings are further split in existing and new buildings in each region where existing buildings have a stock of equipment, including heating technologies, in the start year. The residential end-use demand is split in central heating, point source heating, hot water, and electricity specific demand. For the commercial buildings, end-use demand is divided in central heating, point source heating, cooling, and electricity specific demand. The electric specific demand includes electricity that is non-substitutable with other energy carriers, such as electricity for lighting and equipment.

The investment and operational cost, annual full load hours, efficiencies, lifetimes, and technology learning rates of technologies in buildings are based on "NVEs kostnadsrapport 2017". Equipment in the residential sector includes VAT 25%.

#### *Electric water heater*

An ongoing work is the possibility to have a flexible use of an electric water heater. In the basic version of the IFE-TIMES-Norway model, an in-flexible electric water heater is included. A flexible electric water heater is added to the residential sector as possible choice of technology. It is in principle modelled in two parts; one non-flexible heater like the ordinary technology and one flexible part divided in three parts:

- Part I consist of the heating element using electricity.
- The second step is the storage tank, with losses.
- The last part is providing the hot water demand in combination with the inflexible heater.

The storage loss of the tank is calculated to 3.3% based on producer data of 66 W loss of a 2000 W tank. The maximum flexibility is restricted to 30% of total energy use based on a literature survey. A calculation of requirement of a temperature above a certain level to avoid problems with Legionella support the assumption of 30% flexibility of a hot water tank. This methodology forces the electric water heater to have a load profile like the use of hot water in 70% of the time and the remaining 30% of electricity needed to heat the water can be used at any time of the day.

#### *Temperature dependent efficiency of heat pumps*

The efficiency and the availability of heat output of air-air heat pumps and air-water heat pumps depends on the outdoor temperature, see Figure 89. The nominal COP<sub>33N</sub> for air-water and COP<sub>13N</sub> for air-air used is an average of rated COP's of commercially available heat pumps in each category.

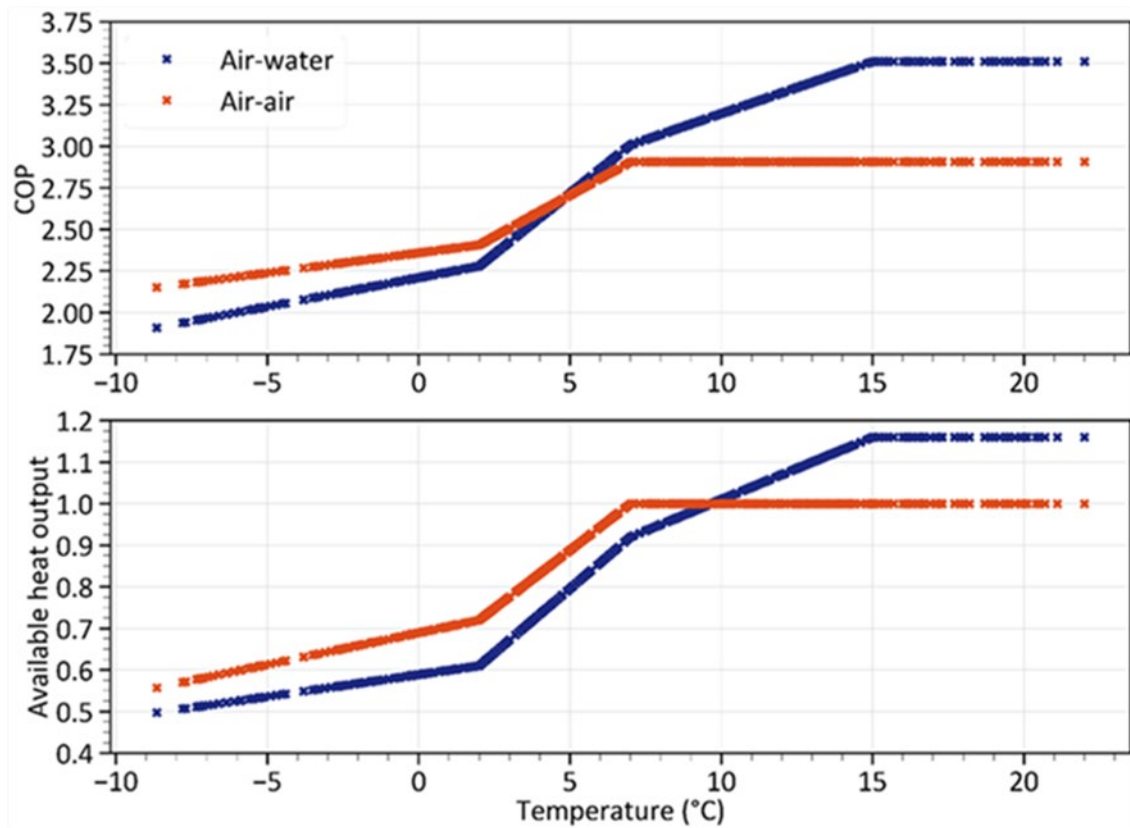

Figure 89. Temperature dependent COP and heat output of nominal capacity for air-water and air-air heat pumps.

## Power system

### *Grid tariffs*

The bill consists of three parts in Norway; 1. The electricity price / marginal cost of electricity from high voltage grid, 2. Taxes and 3. Grid tariff. The grid tariff should represent the cost of investments and maintenance of the distribution grid, in addition to grid losses. Different structure for end-use in residential building and in commercial buildings. The line is often set at yearly demand (lower/higher than 100 000 kWh) or at the size of the main fuse (lower/higher than 125 A).

The modelling of the grid tariff is improved by introduction of new transformation processes that represent the energy meter; one for the residential sector and one for each season of the commercial sector. The tariff structure of today is assumed to be flat energy charge per unit consumed for residential and energy charge with seasonal variations and demand charge for commercial.

All charges are calculated so that if there is no change in demand, i.e., no response to the incentives, the grid tariff income will be the same. The cost level of grid tariffs is assumed to remain at the same throughout the model period.

### **District heating**

District heating has been modelled as one system with several heating plant alternatives in each electricity spot area. To better cover the diversative of different district heating systems, two sizes are introduced – large and small/local district heating grids. This facilitates the incorporation of different specific investment costs of large and small systems and assumptions of technologies to be available for local systems.

In a model like IFE-TIMES-Norway, all buildings have the same costs and availability to use different technologies, if no restrictions are applied. Therefore, a market share often is used, to improve the modelling of actual possibilities and/or different costs or efficiencies.

Please see more info in Chapter 2.4.

## Transport

In the FlexBuild project, the most important part of the transportation sector is the charging of battery electric vehicles. This is described below and further information of modelling of transportation in IFE-TIMES-Norway can be studied in ref. IFE-rapport documentation.

### *Charging of battery electric vehicles*

All electrical vehicles are depending on having available charging infrastructure, which brings an additional cost to the system in comparison with current well-established petrol filling station infrastructure. As a first attempt to include this cost in the model, three different chargers for private vehicles and vans are included: Residential, Commercial and Fast charging. The Commercial charging is defined as slow charging that it is done close to commercial buildings, with intention to represent that the car is charged at work.

For residential and commercial charger, it is assumed the cost of a charger with max output < 11kW and assumed average output of 7kW. For fast charging it is assumed costs of 50kW charger at start year which is fully replaced by 150kW charger in 2025 (Klimakur 2030).

The load profile of charging of battery electric passenger cars is based on ref NVE-rapport 74-2016, see Figure 90. The share of home charging is 75%, at work is 15% and fast charging 10%.

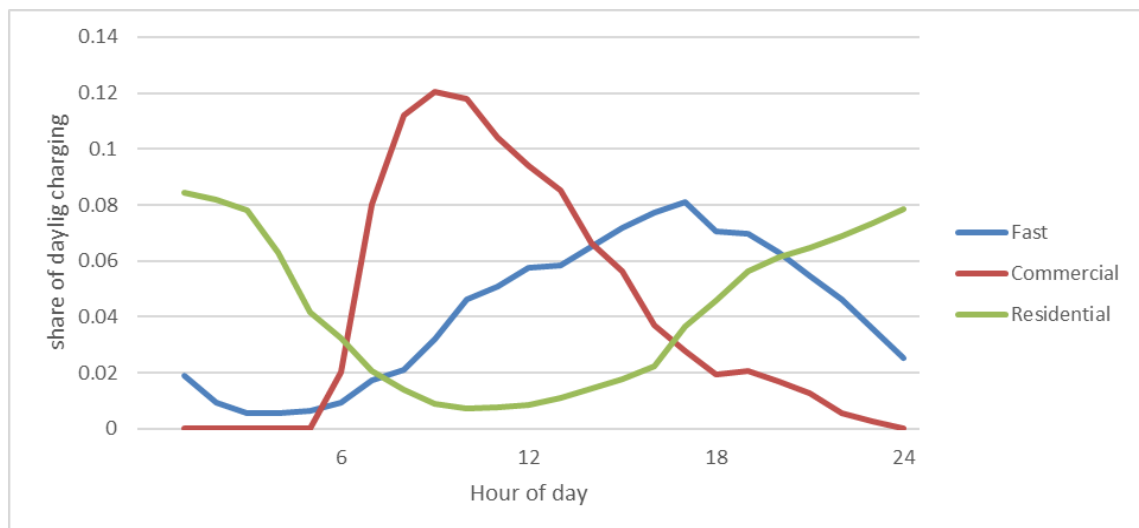

Figure 90. Load profile of charging of passenger cars in average per day per type of charging

In contrast to the ICE vehicle, the BEV's are much more energy efficient, however, EVs lack sufficient waste heat to provide substantial cabin heating. It leads to larger fluctuation in energy demand depending on season for BEV's in comparison with an ICE vehicle. The same seasonal change in efficiency is assumed among all the regions and the seasonal temperature used is weighted among the different regions based on vehicles fleet concentration see Figure 91. Due to the similarity between cars and vans, the same correlation is also assumed for battery powered vans. For more information, see ref IFE-rapport documentation. This work is ongoing and will be improved.

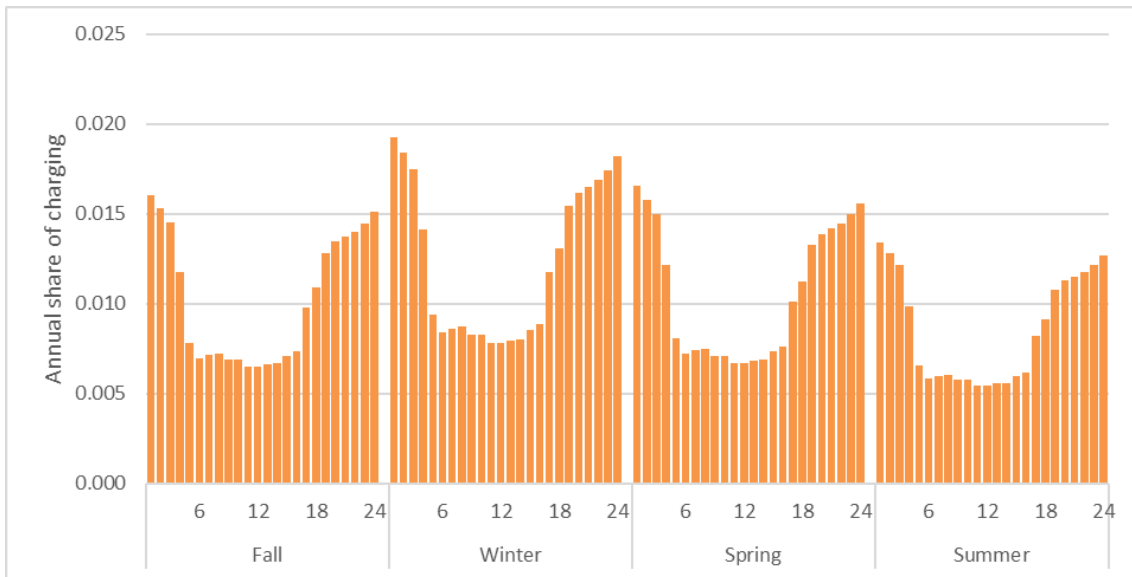

Figure 91. Annual load profile for total charging of passenger cars

### Storyline assumptions for IFE-TIMES-Norway

This section describes the assumptions, that are in line with the long-term storylines, for the Norwegian energy system, model IFE-TIMES-Norway. Note that all four storylines assume that the Norwegian energy system is gradually decarbonized within 2050 and that Norway has no or a limited net import of biomass products.

For the project deliverable of 2021, we have analysed all four scenarios with the IFE-TIMES-Norway model. The model assumptions are summarised in Table 21. The listed TIMES model assumptions will be elaborated further in the sections below. Note that the storyline assumptions are model input and not model results.

Table 21. IFE-TIMES-Norway model assumption for the Petroleum, Energy, Nature and Climate Panic nation storyline.

Model assumption	Petroleum nation	Energy nation	Nature nation	Climate panic
<b>Carbon capture &amp; storage</b>	From 2030	No	From 2030	No
<b>Blue hydrogen production</b>	From 2030	No	No	No
<b>Technology learning: Green hydrogen</b>	Low	High	Moderate	Low to 2030 High in 2050
<b>Technology learning: PV and stationary batteries</b>	Low	High	Moderate	Low in 2030 High in 2050
<b>New wind power potential</b>	Moderate	High	No new capacity	Mod. to 2030 High in 2050
<b>Technology learning: Wind power</b>	Moderate	High	Low	Moderate
<b>National transmission grid expansion</b>	If profitable	If profitable	No	If profitable
<b>International electricity grid expansion</b>	No	If profitable	If profitable	No

Model assumption	Petroleum nation	Energy nation	Nature nation	Climate panic
<b>Road Transport demand projections</b>	High	Moderate	Low	High to 2030 Low in 2050
<b>Industry activity projections</b>	Basis prognosis	Basis prognosis without oil and gas	Status quo without oil and gas	Status quo without oil and gas

### Technology learning: Green hydrogen

Large- and small-scale hydrogen generation from electrolysis is included as an investments option in IFE-TIMES-Norway. The technology learning on investment costs and efficiency varies for the four storylines as indicated in Table 22. The investment costs are interpolated between the specified model periods. Note that the investment cost for the PEM electrolysis include a storage tank, and that the efficiency corresponds to the hydrogen output, in kWh, over the required electricity use, in kWh.

Table 22. Technology learning assumptions for green hydrogen production for the Energy, Petroleum, Nature and Climate Panic nation storylines.

Investment cost, NOK/kW	Storyline	2018	2030	2050
<b>Electrolysis, Alkaline, small</b>	Energy	25 497	14 967	10 199
	Petroleum	25 497	14 967	11 787
	Nature	25 497	14 967	11 369
	Climate	25 497	14 967	10 199
<b>Electrolysis, Alkaline, large</b>	Energy	13 154	7 719	4 475
	Petroleum	13 154	7 719	6 079
	Nature	13 154	7 719	5 864
	Climate	13 154	7 719	4 475
<b>Electrolysis, PEM, small</b>	Energy	24 895	14 092	5 642
	Petroleum	24 895	18 888	11 936
	Nature	24 895	17 069	9 549
	Climate	24 895	18 888	5 642
<b>Electrolysis, PEM, large</b>	Energy	12 426	7 076	3 366
	Petroleum	12 426	9 554	5 993
	Nature	12 426	8 614	4 759
	Climate	12 426	9 554	3 366
Efficiency, H2/ ELC (kWh)	Storyline	2018	2030	2050
<b>Electrolysis, Alkaline, small</b>	Energy	0.62	0.67	0.76
	Petroleum	0.62	0.63	0.67
	Nature	0.62	0.65	0.71
	Climate	0.62	0.63	0.76
<b>Electrolysis, Alkaline, large</b>	Energy	0.62	0.67	0.76
	Petroleum	0.62	0.63	0.65
	Nature	0.62	0.65	0.69
	Climate	0.62	0.63	0.76
<b>Electrolysis, PEM, small</b>	Energy	0.57	0.66	0.72
	Petroleum	0.57	0.62	0.65
	Nature	0.57	0.64	0.69

	Climate	0.57	0.62	0.72
<b>Electrolysis, PEM, large</b>	Energy	0.57	0.66	0.72
	Petroleum	0.57	0.62	0.67
	Nature	0.57	0.64	0.71
	Climate	0.57	0.62	0.72

### Technology learning: Solar power and stationary batteries

The investment costs in residential and commercial solar power differs between the storylines as indicated in Table 23. Note that the investment costs are interpolated between the specified model periods.

Table 23. Technology learning assumptions PV for the Energy, Petroleum, Nature and Climate Panic nation storylines.

Investment cost, NOK/kW	Storyline	2018	2035	2050
<b>Residential solar power</b>	Energy	14 000	10 500	8 000
	Petroleum	14 000	12 800	12 800
	Nature	14 000	10 500	8 000
	Climate	14 000	12 800	8 000
<b>Commercial solar power</b>	Energy	10 000	7 000	5 000
	Petroleum	10 000	9 000	9 000
	Nature	10 000	7 000	5 000
	Climate	10 000	9 000	5 000

Stationary batteries in both residential and commercial buildings are included with the investment costs presented in Table 24.

Table 24. Technology learning assumptions stationary batteries in buildings for the Energy, Petroleum, Nature and Climate Panic nation storylines (NOK/kWh).

Storyline	2018	2025	2030	2035	2040	2050
Energy	5 890	2 000	1 500	1 200	1 000	750
Petroleum	5 890	2 720	2 430	2 140	1 840	1 730
Nature	5 890	2 000	1 500	1 200	1 000	750
Climate	5 890	2 000	1 500	1 200	1 000	750

### Cost for building integrated solar power

The additional cost to building integrated PV (BiPV), compared to building materials, is assumed to differ between the various storylines. Estimating the additional costs of BiPV, with a corresponding upper potential by spot price region, is a part of further work.

### Wind power potential

The wind power potential reflects the upper limit for wind power capacity in Norway. For Nature Nation, we assume that only approved wind power investments will be executed. For the Petroleum Nation, the upper limit for wind power investments is 26 TWh, whereas for the Energy Nation and the Climate Panic nation we assume the potential is 48 TWh as shown by spot price region in Table 25. Note that the indicated wind power potential also includes existing wind power. Consequently, the potential for new investments is 11 TWh and 33 TWh for the Petroleum Nation and Energy Nation respectively. Nevertheless, the model only invests in new wind power if it is profitable from a Norwegian energy system perspective in the Petroleum and Energy nation.

Table 25. Wind power potential for the Energy, Petroleum, Nature and Climate Panic nation storylines.

Wind potential, TWh	Storyline	NO1	NO2	NO3	NO4	NO5	Total
	Energy	1.7	11.7	15.0	19.1	0.5	<b>48</b>
	Petroleum	1.1	7.0	9.7	7.9	0.2	<b>26</b>
	Nature	0.8	4.7	7.1	2.4	0.1	<b>15</b>
	Climate	1.7	11.7	15.0	19.1	0.5	<b>48</b>

### Technology learning: Wind power

For *Petroleum nation* we assume that the investment costs range from 17 700 to 10 600 NOK/kW in 2020 and from 13,400 to 4,000 NOK/kW in 2035. For the *Energy nation* we assume that the technology learning on wind power higher than *Petroleum nation* where the investment costs in new wind power is 10% lower from 2035 and forward. Note that the investment costs are interpolated between the specified model periods and extrapolated from 2035. For all storylines, the annual capacity factor, representing operating hours, from 0.28 to 0.43, depending on location.

### Transmission grid expansion

The possibilities to invest and expand national transmission capacities between the regions is set to be done only if it is profitable for Norway in the *Petroleum Nation*, *Energy nation* and *Climate Panic nation*. The assumed investments costs and the assumed existing capacity between the Norwegian spot price regions are shown in Table 26. For the *Nature nation* we do not allow for any further expansion of the national transmission grid. For *Petroleum Nation*, *Energy nation* and *Climate Panic nation* we set a maximum new capacity expansion of the national transmission to equal the existing transmission capacity as between the model regions as shown in Table 26.

Table 26. Investment cost for new national transmission capacity and existing national transmission capacity in 2020.

Investment cost, NOK/kW	NO1	NO2	NO3	NO4	NO5
<b>NO1</b>		841	2,049		1,216
<b>NO2</b>	841				1,265
<b>NO3</b>	2,049			3,807	1,195
<b>NO4</b>			3,807		
<b>NO5</b>	1,216	1,265	1,195		

Transmission capacity, MW	NO1	NO2	NO3	NO4	NO5
<b>2020</b>					
<b>NO1</b>		3,500	500		3,900
<b>NO2</b>	3,500				600
<b>NO3</b>	500			1,200	500
<b>NO4</b>			1,200		
<b>NO5</b>	3,900	600	500		



Table 27. Investment cost for new international transmission capacity and existing international transmission capacity in 2020.

Investment cost, NOK/kW	NO1	NO2	NO3	NO4	NO5
SE3	1,264				
DK1		5,714			
DE		8,750			
NL		8,570			
UK		14,285			14,285
Transmission capacity, MW	NO1	NO2	NO3	NO4	NO5
<b>2020</b>					
SE1				700	
SE2			1,000	300	
SE3	2,145				
DK1		1,632			
RUS					56
DE		1,400			
NL		723			
UK		1400			

Grid expansion to countries outside Norway is not allowed for *Petroleum Nation* and *Climate Panic Nation* as it is in line with current trends. For *Energy Nation* and *Nature Nation* grid expansion is done if it is profitable for Norway. The assumed investment cost of new capacity is shown in Table 27, where the investment cost varies due to the distance and technologies (cable vs. lines). Table 27, also shows the current international trade capacity that is the same for all storylines. New international transmission capacity to European countries is limited to 1,400 MW.

### Demand projections

The annual demand of energy services in buildings are an input to IFE-TIMES-Norway as well as the load profiles, the sub-annual hourly load variations and are based on the work done by SINTEF Community, described earlier in this report.

The energy demand of the Norwegian industry as well as of the buildings is shown in Figure 92, for the four scenarios.

In *Energy nation*, Norway is described as a big exporter of energy intensive goods, and this is reflected in the demand of energy services as a doubling of the electricity use in energy intensive industry towards 2050. At the same time, it is assumed that the oil and gas production is phased out. As a result of this the electricity used for offshore installations is assumed linearly phased out from 2030 to 2050 and the oil refineries are closed.

The demand projection of *Petroleum Nation* is mainly based on known and planned changes in industry. Expectations of electricity use for data centres and electrification of offshore oil and gas installations are included.

The *Nature nation* and *Climate Panic Nation* assumes a constant demand from 2020 to 2050 and a linearly phase out of electricity for offshore activities from 2030 to 2050. This implies that we assume that the industry activity is like the current activity in 2050 except the oil and gas sector that is phased out.

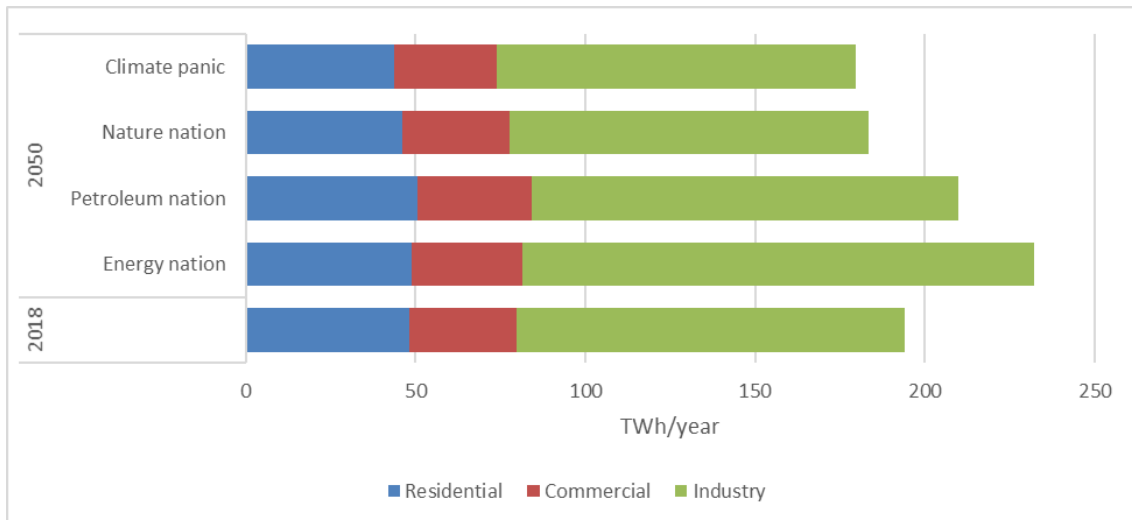

Figure 92. Energy demand in buildings (residential and commercial) and in industry 2018 and in 2050 for the four scenarios, TWh/year

The demand of energy services in transport sector differs for the three storylines as shown in Figure 93. We assume that *Petroleum nation* has the highest transport energy service demand in transport, and we assume this projection corresponds to "Nasjonal Transportplan" (NTP 2018–2029). Further, we assume the demand projections are of *Energy nation* is lower than *Petroleum nation* where the projections are according to "Nasjonalbudsjett 2019". Finally, we assume that the transport demand in *Nature nation* is the lowest among the storylines where the projections are inspired by "Klimakur 2030". In the *Climate Panic Nation*, the transport demand is as in *Petroleum nation* until 2030 and then rapidly decrease to become equal as in *Nature nation* in 2050.

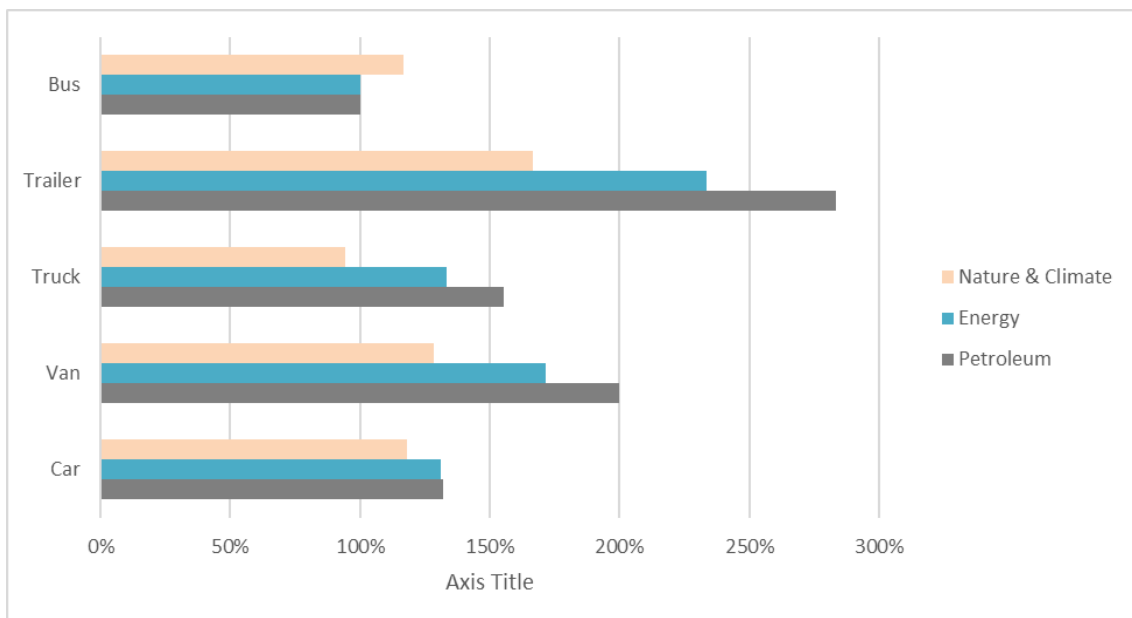

Figure 93. Relative development of energy service demand of road transport in 2050 compared to 2018 for the four storylines.

### European electricity prices

IFE-TIMES-Norway uses electricity prices for countries with transmission capacity to Norway from EMPIRE. We assume that the European electricity sector is decarbonized towards 2050 and difference between the storylines is whether Carbon Capture and Storage (CCS) is a commercially available technology or not. For *Petroleum nation* and *Nature nation* we assume that CCS is commercially available in the electricity generation technology in Europe, whereas

in *Energy nation* and *Climate Panic nation* we assume that CCS is not available as a commercial option in Europe towards 2050.

## **Appendix F: Single building case study**

## F.1 Submodel development

In the following, we describe the extensions of the MILP BUTLER model [1] which has been re-implemented in the open-source Python-based optimization suite Pyomo [2]. BUTLER is a techno-economic optimisation tool applied to one single building. The model supports investments in heating technologies, storage technologies and power generating technologies. With its hourly time resolution, BUTLER accounts for detailed operational insights. The objective function represents the net present value (NPV) of the total costs of the energy system within the building, which depends on the installed capacity,  $x_i$ , of each energy technology  $i$ . The discounted investment costs,  $c^{\text{inv}}$ , consist of re-investments throughout the entire lifetime of the building minus its salvage value at the end of the lifetime.  $c^{\text{run}}$  is the sum of fixed maintenance costs and variable fuel costs. The discounted NPV of the total operational costs equals the annual operational costs divided by the annualisation factor,  $e$ . The building's energy system must fulfill the equalities  $\mathbf{h}(x_i)$ , and inequalities  $\mathbf{g}(x_i)$  constraints dependent on the installed capacity for all the energy technologies of the vector  $\mathbf{x}$ .

$$\min \pi = \min \left( \sum_{i \in \mathcal{I}} c_i^{\text{inv}}(x_i) + c_i^{\text{run}}(x_i, k_j) \right) \quad (\text{F.1})$$

$$s.t. \mathbf{h}(k_j) = 0 \quad (\text{F.2})$$

$$\mathbf{g}(x_i) \geq 0 \quad (\text{F.3})$$

where  $x_i$  is the size of each technology  $i \in \mathcal{I}$ , and  $k_j$  is the consumption of each energy carrier  $j \in \mathcal{J}$ .

## F.2 Space heating flexibility

Space heating.

## F.2.1 Separation of heat demand

What drives the BUTLER model is the demand for energy, originally separated on electricity demand ( $D^{\text{EL}}$ ) and heat demand ( $D^{\text{HT}}$ ) [1]. In this paper, the demand for heat is further split into space heating demand ( $D^{\text{SH}}$ ) and domestic hot water demand ( $D^{\text{DHW}}$ ), as first introduced in [3]. The following constraints Eq. (F.37)-(F.36) assures that all the demands  $\{D^{\text{EL}}, D^{\text{SH}}, D^{\text{DHW}}\}$  are met for all  $t \in \mathcal{T}$ :

$$D_t^{\text{EL}} = y_t^{\text{imp}} - y_t^{\text{exp}} - \sum_{i \in \mathcal{I}^{\text{SH}}} y_{i,t}^{\text{SH}} - \sum_{i \in \mathcal{I}^{\text{DHW}}} y_{i,t}^{\text{DHW}} + \sum_{i \in \mathcal{I}^{\text{EL}}} y_{i,t}^{\text{EL}} \quad (\text{F.4})$$

$$D_t^{\text{SH}} = \sum_{i \in \mathcal{I}^{\text{SH}}} q_{i,t}^{\text{SH}} \quad (\text{F.5})$$

$$D_t^{\text{DHW}} = \sum_{i \in \mathcal{I}^{\text{DHW}}} q_{i,t}^{\text{DHW}} \quad (\text{F.6})$$

Here,  $y_{i,t}$  represents both the generation of electricity from technology  $i \in \mathcal{I}^{\text{EL}}$ , and the use of electricity in heat technology  $i \in \mathcal{I}^{\text{SH}} \cup \mathcal{I}^{\text{DHW}}$ .  $q_{i,t}$  is heat generated by technology  $i \in \mathcal{I}^{\text{SH}} \cup \mathcal{I}^{\text{DHW}}$ . Notice that  $\mathcal{I} = \mathcal{I}^{\text{SH}} \cup \mathcal{I}^{\text{DHW}} \cup \mathcal{I}^{\text{EL}}$ .

## F.2.2 Grey-box model representing the space heating demand

A general grey-box model structure for describing the dynamics of the building envelope has been implemented. From [4], the full model is a stochastic, linear, continuous-time state space models on the form:

$$\dot{z} = \mathbf{A}z + \mathbf{B}u + w \quad (\text{F.7})$$

where  $\mathbf{A}$  is the state transition matrix,  $\mathbf{B}$  maps from the inputs  $u \in \mathbb{U} \subset \mathbb{R}^{\times u}$  to the states  $z \in \mathbb{Z} \subset \mathbb{R}^{\times z}$ , and  $w \in \mathbb{W} \subset \mathbb{R}^{\times w}$  is the diffusion term. Since we consider deterministic realizations of the models, we assume  $w$  to be zero in the discretization, given by [5]:

$$\mathbf{A}_d = e^{\mathbf{A}\Delta t} \quad (\text{F.8})$$

$$\mathbf{B}_d = \mathbf{A}(\mathbf{A}_d - \mathbf{I})\mathbf{B} \quad (\text{F.9})$$

where  $\Delta t$  is the sampling time, taken to be one hour in this work to make it comply with the rest of BUTLER. Applying the transformation from continuous-time in Eq. (F.7) to a discretized state-space given by Eq. (F.8)–(F.9), the grey-box model can be implemented

directly in BUTLER using Eq. (F.10)–(F.12),  $\forall t \in \mathcal{T} \setminus |\mathcal{T}|$ :

$$z_{t+1}^1 = a_{11}z_t^1 + a_{12}z_t^2 + \dots + a_{1n}z_t^n + b_{11}u_t^1 + b_{12}u_t^2 + \dots + b_{1m}u_t^m \quad (\text{F.10})$$

$$z_{t+1}^2 = a_{21}z_t^1 + a_{22}z_t^2 + \dots + a_{2n}z_t^n + b_{21}u_t^1 + b_{22}u_t^2 + \dots + b_{2m}u_t^m \quad (\text{F.11})$$

$$\vdots$$

$$z_{t+1}^n = a_{n1}z_t^1 + a_{n2}z_t^2 + \dots + a_{nn}z_t^n + b_{n1}u_t^1 + b_{n2}u_t^2 + \dots + b_{mn}u_t^m \quad (\text{F.12})$$

where  $n = \varkappa_x$  and  $m = \varkappa_u$ , and the components of  $\mathbf{A}_d$  and  $\mathbf{B}_d$  have been written out explicitly.

### F.2.3 Concrete model

Populating the  $a$ 's and  $b$ 's in the grey-box model, we use the results from [6] that identified a large apartment block as a three-state grey-box model, based on data from a white-box IDA-ICE model. Hence, we have a parameterization of the general structure given by Eqs. (F.10)–(F.12), with:

$$z_t = [T_t^{\text{in}}, T_t^{\text{m}}, T_t^{\text{e}}]^T, u_t = [\phi_t^{\text{h}}, T_t^{\text{a}}, \phi_t^{\text{s}}, \phi_t^{\text{int}}]^T \quad (\text{F.13})$$

where  $\phi_t^{\text{s}}$  is the solar gain,  $T_t^{\text{a}}$  the ambient temperature and  $\phi_t^{\text{int}}$  the internal gains, all at time step  $t \in \mathcal{T}$ . The last step is to replace the input parameter of the space heating demand in BUTLER,  $D^{\text{SH}}$ , with the heat consumed by the building  $\phi_t^{\text{h}}$ . We rewrite Eq. (F.35) to:

$$\phi_t^{\text{h}} = \sum_{i \in \mathcal{I}^{\text{SH}}} q_{i,t}^{\text{SH}} \quad (\text{F.14})$$

By this, the space heat demand is now a variable instead of a parameter. The "comfort"-constraint applied to the envelope model is defined by a lower and an upper bound of the indoor temperature, respectively  $T_t^{\text{in,lo}}$  and  $T_t^{\text{in,up}}$ :

$$T_t^{\text{in,lo}} \leq T_t^{\text{in}} \leq T_t^{\text{in,up}} \quad (\text{F.15})$$

## F.3 Domestic Hot Water Flexibility

We also want to investigate the flexibility the possible flexibility in hot water tanks.

### F.3.1 Model formulation

For that purpose, we have formulated a simple, one-node model for the dynamic behaviour of a hot water tank.

$$dT_{ta} = \frac{1}{R_{ti}C_t}(T_t - T_i)dt + \frac{1}{C_t}P_{dhw} + \sigma_t dw_t \quad (\text{F.16})$$

the parameters

$C_t$  - Heat capacity for the tank [ $\frac{kWh}{K}$ ]

$R_{ti}$  - Thermal resistance from tank to interior [ $\frac{K}{kW}$ ]

$\sigma_h$  - Wiener process variance for  $T_t$

the states:

$T_{ta}$  - Temperature, top of tank [ $K$ ]

$T_i$  - Interior (ambient) temperature [ $K$ ]

and the inputs:

$P_{dhw}$  - Net heat, tank [ $kW$ ]

$T_i$  - Interior temperature [ $K$ ]

make up the state-space model. We need the constraint ( $\forall t \in \mathcal{T}, \forall s \in \mathcal{S}$ ):

$$T^{\text{hy,lower}} \leq T_{t,s}^{\text{ta}} \leq T^{\text{hy,upper}} \quad (\text{F.17})$$

where  $T^{\text{hy,upper}} - T^{\text{hy,lower}} = \Delta T$  is the hysteresis of the water tank.

### F.3.2 Linear example

To parameterize the model above, we use the equation [?]

$$a = 7.5 \cdot 10^{-4} \cdot (1.55(T_{\text{acc}} + 1.2) - T_{\text{min}}) \quad (\text{F.18})$$

for the capacitance  $C_{ta}$ , where  $T_{\text{acc}}$  is the set-point temperature of the tank and  $T_{\text{min}}$  is the temperature at which the water is drawn from the tank (?). For the resistance, we use manufacturer's data [7] (which is certified according to EN 12897):



Table F.1: Tank losses.

Size	$P_{\text{loss}} [W]$	$R_{\text{ti}} [\frac{K}{kW}]$
372L	90	388.89
550L	155	225.81
885L	175	200

where the formula

$$R_{\text{ti}} = \frac{\Delta T_{\text{ti}}}{P_{\text{loss}}} \quad (\text{F.19})$$

has been used to find the resistance  $R_{\text{ti}}$ .  $\Delta T_{\text{ti}}$  is the assumed temperature difference between tank and the interior. Since we aim to capture a "representative" temperature with the one-node model, we set this to be  $\Delta T_{\text{ti}} = 40K$  (Tank temperature 60 °C, interior 20 °C).

$$T_{\text{acc}} = \frac{T^{\text{hy,lower}} + T^{\text{hy,upper}}}{2} \quad (\text{F.20})$$

We set up a table of different configurations, since the tank sizes need to be fixed in order to keep the model linear. Since we try to model a "representative" temperature of the tank (i.e. neither the top, nor the middle), we assume  $T_{\text{acc}} = 60$  °C and  $T_{\text{min}} = 60$  °C, which yields

$$a \approx 0.026 \left[ \frac{kWh}{L} \right] \quad (\text{F.21})$$

Again, we need to assume a temperature difference, but this time for the temperature difference between the top and bottom of the tank  $\Delta T_{\text{tb}}$ . We set this to 35K (Top temperature 75 °C, bottom temperature 75 °C). Then we can use the formula:

$$C_{\text{ta}} = \frac{aV}{\Delta T_{\text{tb}}} \quad (\text{F.22})$$

where  $V$  is the water volume of the tank in litres. For the tank sizes tabled in F.2, we get:

Table F.2: Tank losses.

Size	$C_{\text{ta}}$	$C_{\text{ta}}^{\text{th}}$
372L	0.28	0.43
550L	0.41	0.64
885L	0.66	1.03

where the formula

$$C_{\text{ta}}^{\text{th}} = \frac{V\rho c_p}{3.6 \cdot 10^3 \left[ \frac{kJ}{kWh} \right]} \quad (\text{F.23})$$

is used to find the theoretical capacitance  $C_{ta}^{th}$  from the intrinsic heat capacity of water  $c_p \left[ \frac{\text{kJ}}{\text{kg}^\circ\text{C}} \right]$ . We observe that the "estimated" capacitance is almost half that of the theoretical capacitance.

## F.4 Flexible charging of Electric Vehicles (EV)

We want to get an estimate of the flexibility that can be gained from charging EVs optimally.

### F.4.1 EV model

We define a simple model for EV charging next to the building behind its main meter, based on only three parameters:

- $\Lambda_{v,t}^{EV}$ , the availability of the EV (boolean)
- $D_{v,e}^{EV}$ , the energy demand of the charging event  $e$  (kWh)
- $EV^{lim}$ , the maximum charging power of the EV (kW)

The set  $\mathcal{E}_v$  contains all charging events  $e$  for each car  $v \in \mathcal{V}$ , where  $\mathcal{V}$  is the set of EVs connected to the buildings and hence  $|\mathcal{V}| = N$  is the number of EVs. Each event  $e \in \mathcal{E}_v$  is associated with a set of time steps,  $\mathcal{T}_{v,e}$ , where  $\Lambda_{v,t}^{EV} = 1$  for the vehicle  $v$ . These sets are generated by looping through the real data on charging events from [8]. The cars may be charged in a flexible or non-flexible way. The non-flexible charging, i.e. the static model, is our baseline case. Here we assume that the EV will start charging at its maximum power  $EV^{lim}$  immediately upon plug-in. This creates a load profile of  $D_t^{EV}$ . Since there is no flexibility involved we do not need any information on the availability of the car  $v$ , and hence the electricity use for charging is simply:

$$y_{v,t}^{staticEV} \geq D_{v,t}^{EV}, \forall v \in \mathcal{V}, \forall t \in \mathcal{T} \quad (\text{F.24})$$

where  $\mathcal{T}$  is the set of all time steps for the optimization horizon. The flexible charging allows for shifting the charging within the time frame of a charging event,  $\mathcal{T}_e$ . At each time step, the electricity used for flexible EV charging,  $y_{v,t}^{flexEV}$ , cannot exceed the maximum charging capacity of the car,  $EV^{lim}$ :

$$y_{v,t}^{flexEV} \leq \Lambda_{v,t}^{EV} EV^{lim}, \forall v \in \mathcal{V}, \forall t \in \mathcal{T}_{v,e} \quad (\text{F.25})$$

In Eq. (F.26), the sum of electricity charged over all hours in a charging event  $e$ , equals the energy demand of the charging event,  $D_e^{EV}$ . Here,  $\mathcal{T}_{v,e}$  denotes the set of time steps associated

with the charging event  $e$  and vehicle  $v$ :

$$\sum_{t \in \mathcal{T}_e} y_{v,t}^{\text{flexEV}} \geq D_{v,e}^{\text{EV}}, \forall v \in \mathcal{V}, \forall e \in \mathcal{E}_v \quad (\text{F.26})$$

## F.4.2 Grid tariffs

From the perspective of the power system, limiting the peak power is a key motivating factor for implementing flexible EV-charging and/or demand-side flexibility. In this paper we investigate a monthly and daily peak power tariff, and compare it to the current energy tariff scheme.

Table F.3: Set definitions.

Set	Description	Index
$\mathcal{T}$	All timesteps	$t$
$\mathcal{M}$	All months	$m$
$\mathcal{W}$	All weeks	$w$
$\mathcal{D}$	All days	$d$

- $\mathcal{T}$ , the set of all timesteps
- $\mathcal{M}$ , the set of all months
- $\mathcal{W}$ , the set of all weeks
- $\mathcal{D}$ , the set of all days

Furthermore, let an index set  $\mathcal{I}$  of a set  $\mathcal{A}$  be defined in the following manner:

$$\bigcup_{i=1}^{|\mathcal{I}|} \mathcal{A}_i = \mathcal{A}_1 \cup \mathcal{A}_2 \cup \mathcal{A}_3 \cup \dots \cup \mathcal{A}_{|\mathcal{I}|} = \mathcal{A} \quad (\text{F.27})$$

where the operator  $|\cdot|$  yields the number of elements in a set. Let the set  $\mathcal{T}$  have both  $\mathcal{D}$  and  $\mathcal{M}$  as its index sets. This is to iterate through the time steps  $t \in \mathcal{T}$  of both a given day and month. Let also the sets  $\mathcal{D}$  and  $\mathcal{M}$  have  $\mathcal{T}$  as their index set. This is to look up the particular day or month associated with a given time step  $t \in \mathcal{T}$ . The **monthly peak power grid tariff (PPM)** is included by adding Eq. (F.28) to the objective function in Eq. (F.1).

$$C^{\text{fxd\_pp}} + \sum_{m \in \mathcal{M}} \sum_{t \in \mathcal{T}_m} \left( C_m^{\text{pty\_pp}} y_m^{\text{max\_imp}} + C_m^{\text{spe\_pp}} y_t^{\text{imp}} \right) \quad (\text{F.28})$$

Here,  $C^{\text{fxd\_pp}}$  is the fixed annual charge,  $C_m^{\text{pty\_pp}} [\frac{\text{€}}{\text{kW}}]$  the peak power charge for each month  $m$ , and  $C_m^{\text{spe\_pp}} [\frac{\text{€}}{\text{kWh}}]$  the energy charge. Furthermore, the variable  $y_m^{\text{max\_imp}}$  denotes the

maximum electricity import for each month, and  $y_t^{\text{imp}}$  the electricity import at each time step  $t$ . The monthly charges are summed over all months  $\mathcal{M}$ , with their corresponding time steps  $\mathcal{T}_m$ . To find the monthly peak import, Eq. (F.29) ensures that the highest value of  $y_t^{\text{imp}}$  per month is stored in  $y_m^{\text{max\_imp}}$ .

$$y_m^{\text{max\_imp}} \geq y_t^{\text{imp}}, \forall m \in \mathcal{M}, t \in \mathcal{T}_m \quad (\text{F.29})$$

The **daily peak power tariff (PPD)** is defined similarly, summing over days instead of months

$$C^{\text{fxd\_pd}} + \sum_{d \in \mathcal{D}} \sum_{t \in \mathcal{T}_d} \left( C_d^{\text{pty\_pd}} y_d^{\text{max\_imp}} + C_d^{\text{spe\_pd}} y_t^{\text{imp}} \right) \quad (\text{F.30})$$

with the constraint

$$y_d^{\text{max\_imp}} \geq y_t^{\text{imp}}, \forall d \in \mathcal{D}, t \in \mathcal{T}_d \quad (\text{F.31})$$

### F.4.3 Multi-objective

Finally, we define a second objective which we call *flattening objective*. Its goal is to reduce the variations in the electricity import  $y_t^{\text{imp}}$  from one time step to the next.

$$\min_{\forall t \in \mathcal{T} \setminus 0} (y_t^{\text{imp}} - y_{t-1}^{\text{imp}})^2 \quad (\text{F.32})$$

When including this term in the objective function, we use the a priori weighting factor  $\lambda_2$ , such that the total objective function becomes:

$$\min_{\forall t \in \mathcal{T}} \lambda_1 \pi + \min_{\forall t \in \mathcal{T} \setminus 0} \lambda_2 (y_t^{\text{imp}} - y_{t-1}^{\text{imp}})^2 \quad (\text{F.33})$$

where a weighting factor  $\lambda_1$  has been added to the original objective as well. To enable a purely "physical" optimization, i.e. one that is independent of any price signal, we instead define the term  $\pi_1$  as the minimization of the imported electricity:

$$\pi_1 = y_t^{\text{imp}} \quad (\text{F.34})$$

such that the optimization is only based on minimizing energy/power.

### F.4.4 Balancing constraints of the building

These constraints assures that all loads of the building  $\{D^{\text{SH}}, D^{\text{DHW}}, D^{\text{EL}}, D^{\text{EV}}\}$  are covered. The space heating load,  $D^{\text{SH}}$ , is met by an electric panel oven (PO):

$$D_t^{\text{SH}} = q_{\text{PO},t}^{\text{SH}} \quad (\text{F.35})$$

The domestic hot water load,  $D^{\text{DHW}}$ , is met by an electric boiler (EB):

$$D_t^{\text{DHW}} = q_{\text{EB},t}^{\text{DHW}} \quad (\text{F.36})$$

The electricity balance of the building in Eq. (F.37), includes the building's electric specific demand  $D_t^{\text{EL}}$ , the electricity consumed by the heat technologies, the electricity demand of the EVs, as well as the import and export of electricity from/to the grid.

$$D_t^{\text{EL}} + y_{\text{PO},t}^{\text{SH}} + y_{\text{BE},t}^{\text{DHW}} + \sum_{v \in V} y_{v,t}^{\text{EV}} = y_t^{\text{imp}} \quad (\text{F.37})$$

where

$$y_t^{\text{EV}} = \begin{cases} y_{v,t}^{\text{flexEV}}, & \text{if flexible charging} \\ y_{v,t}^{\text{staticEV}}, & \text{otherwise} \end{cases} \quad (\text{F.38})$$

### F.4.5 EV charging data

The EV charging data from [8] contains EV charging reports for 6,878 charging events by 97 EV users. The charging reports describe identifiers, plug-in time, plug-out time and charged energy for each charging event. Charging events from 10 selected EV users are included in the case study. The selected EV users have an annual charging demand between 2090 kWh and 3380 kWh during 2019. The charging data is described in more detail in [9] and [8].

## F.5 Case Study

This section explains how the data for the reference/non-flexible case is obtained. Then, the case study is described, and we present the six different use cases.

### F.5.1 Input data

The PROFet model is used to generate load profiles for electric specific demand, space heating demand and domestic hot water demand. The methodology is described in [10], [11]. For the weather and spot price data, the meteorological year 2012 is used, with Oslo, Norway as the location.

### F.5.2 Description of case study

The case study we present here consists of an apartment block with a total area of 1672  $m^2$  (referred to as "AB\_03, Variant 2" in [12]), where we assume that the envelope can be represented by the grey-box model described and identified in [6]. The apartment block consists of 24 apartments, however, we consider the aggregated dynamics of the building, with  $T^{\text{in}}$  representing the arithmetic average of all room temperatures.

Table F.4: Case description.

<b>Name</b>	<b>Description</b>
<b>Heating system</b>	
<b>PO</b>	Building is heated by panel ovens (PO).
<b>A2A</b>	Building is heated by air-to-air heat pump (A2A), combined with PO.
<b>GSHP</b>	Building is heated through a waterborne heat distribution system, heated by a ground sourced heat pump (GSHP), combined with an electric boiler (EB).
<b>Flexibility options</b>	
<i>nf</i>	Non-flexible loads excl. EV, <i>baseline</i>
<i>flex_SH</i>	Flexible SH
<i>flex_DHW</i>	Flexible DHW
<i>nf_EV</i>	<i>baseline</i> incl. EV.
<i>flex_EV</i>	Flexible EV
<i>flex_SH_DHW_EV</i>	Flexible SH, DHW, EV
<b>Objective functions</b>	
<b>EP</b>	Energy pricing grid tariff. Cost minimisation.
<b>PPM</b>	Monthly peak power grid tariff and cost minimisation
<b>PPD</b>	Daily peak power grid tariff, and cost minimisation
<b>FLAT</b>	Cost minimisation and flattening objective

### F.5.3 Space heating

#### Calibration efforts to establish the baseline

To establish the baseline for evaluating the flexibility of the building thermal mass, we force the heat generated by the heating technologies,  $\phi_h$ , to track the static profile  $D^{\text{SH}}$ . We can formulate an objective function as the minimization of the mean-squared error (MSE) of these two vectors:

$$\min \left( D^{\text{SH}} - \phi_h \right)^2 \quad (\text{F.39})$$

Replacing Eq. (F.39) with the objective defined in Eq. (F.1) with time series of the indoor temperature resulting from this optimization,  $T_t^{\text{in,min}}$ , is being used as the lower bound on the temperature in Eq. (F.15). The upper bound,  $T_t^{\text{in,up}}$ , is removed. This is done to enable consistency between the baseline and flexible cases.

#### Heating systems

We consider three distinct heating systems, where each case/system has its own baseline, denoted *nf*, short for *no flexibility*. The **DIR** case investigates the flexibility potential if the building is heated with direct electricity using electric panel ovens (*PO*), the most common heating system in Norway [13]. The **A2A** case combines individual air-to-air (*A2A*) heat pumps, and electric panel ovens which cover the peak load. Both of these configurations fall under the *point-source heating* category, meaning the building does not have a waterborne heat distribution system. The last case, **GSHP**, includes a *waterborne heating system*, heated by a ground-source heat pump (*GSHP*), combined with an electric boiler (*EB*) to cover the peak load. The modelling of the hourly COP of the two heat pumps are based on [14], combined with several manufacturers' data. Finally, the activation of the grey-box model for space heating is denoted *flx*.

All cases have a forced investment in a hot water tank of at least 50 kWh, which provides some flexibility to the demand  $D^{\text{DHW}}$ . Furthermore, the **GSHP** case has a forced investment in an accumulator tank of 21 kWh, which is based on a rule-of-thumb from industry of 15-20 *L* storage per kW installed heat pump capacity. Furthermore, we use an equation from [?], which yields an accumulation factor of  $a \sim 0.05 \frac{\text{kWh}}{\text{L}}$  assuming  $\Delta T = 30\text{K}$ . Table F.4 summarizes the use cases.

### F.5.4 EV charging

We consider the loads for space heating, hot water and electric specific demand  $\{D^{\text{SH}}, D^{\text{DHW}}, D^{\text{EL}}\}$  to be fixed, i.e. we only consider the flexibility potential of the EV-charging. The methodology used to generate load profiles is described in [10], [11].

Based on the current EV share in Oslo at 22 % [15], and EVs 50% market share of new car sales, we assume 0.4 EVs per apartment unit, in total 10 EVs. The EV data (see F.4.5 for short description), which is from 2019, is organised such that the weekends match with the 2012 scenario data.

Five use cases are investigated, each described in Table F.5. The baseline reflects non-flexible charging, i.e. EV load profiles based on charging reports (the data from [8]), and assuming charging at 7.2 kW immediately upon plug-in. In the next four cases, the flexible charging is enabled applying different grid tariff schemes. The FLAT case uses energy minimization and adds a target of flattening the electricity import to the objective function. The parameters of the grid tariffs are presented in Table F.6.

Table F.5: Case description.

<b>Name</b>	<b>Description</b>
<b>EP</b>	Energy pricing grid tariff. Cost minimisation.
<b>PPM</b>	Monthly peak power grid tariff and cost minimisation
<b>PPD</b>	Daily peak power grid tariff, and cost minimisation
<b>FLAT</b>	Cost minimisation and flattening objective

Table F.6: Grid tariff parameters

<b>Name</b>	<b>Value</b>	<b>Unit</b>	<b>Description</b>
$C^{fxd\_ep}$	1426	€	Fixed charge, <b>EP</b>
$C^{spe\_ep}$	0.05	€/kWh	Specific charge, <b>EP</b>
$C^{fxd\_pp}$	404	€	Fixed charge, <b>PPM</b>
$C^{pty\_pp}$	14.9	€/kW	Penalty charge, <b>PPM</b>
$C^{spe\_pp}$	0.008	€/kWh	Specific charge, <b>PPM</b>
$C^{fxd\_dp}$	300	€	Fixed charge, <b>PPD</b>
$C^{pty\_dp}$	0.5	€/kW	Penalty charge, <b>PPD</b>
$C^{spe\_dp}$	0.005	€/kWh	Specific charge, <b>PPD</b>



## F.5.5 DHW Flexibility

For the DHW-flexibility, the distinction between the baseline and the flexible case is as follows:

1. *baseline* - The temperature of the tank must be kept at 55 degrees C. This means that the energy use going to DHW is equal to PROFet + losses to ambient.
2. *flex\_DHW* - The temperature of the tank can exceed the set-point temperature and go as high as 80 degrees C. The lower limit is 50 degrees C.

## F.6 Results

In this section, the results when activating the different flexibility options will be shown.

### F.6.1 Space heating results

Our hypothesis is that by utilizing the building thermal mass, in this paper defined as *comfort flexibility*, a reduction in the space heating load can be achieved by overheating the building in hours before a peak occurs. In this way, the heat generated from heat pumps or other electric heating can be curtailed or shifted, thereby reducing the building's total electricity use in these hours.

Table F.7: Results of selected KPIs

KPIs	Use Cases					
	DIR		A2A		GSHP	
	<i>nf</i>	<i>flx</i>	<i>nf</i>	<i>flx</i>	<i>nf</i>	<i>flx</i>
Peak load [kW]	80	75	80	64	43	39
Total cost [k€]	611	606	508	497	406	405
Cost operations [k€]	39	39	29	29	19	19
Cost investments [k€]	30	26	75	68	122	122
El. imp. [MWh/yr]	296	297	213	212	130	129
<b>Optimal caps. [kW]</b>						
Panel ovens	58.3	47.1	54.1	22.2	-	-
Air-to-air HP	0	0	39.6	41.9	-	-
Ground source HP	-	-	-	-	35.9	36.4
Electric boiler	-	-	-	-	21.2	17.2

## Without flexibility

Table F.8 shows that the **GSHP** case has the lowest operational costs and lowest amount of electricity bought from the grid, but the investment costs are almost ten-fold higher than the **DIR** case that uses electric panel ovens for space heating. The NPV of the total costs is lowest for the case with the ground-source heat pump, however this is without the cost of the waterborne heating distribution system within the building. One way to interpret the difference in NPV between **DIR** and **GSHP**, is as the maximum NPV of the waterborne heating system at which the case **GSHP** is the most profitable.

## Activation of flexibility

Activation of the flexibility reduces the electricity peak load in all cases (cf. Table F.8). When activating the thermal flexibility in the **DIR** case, the peak import of electricity is reduced by 4.9 kW, equivalent to 6%. In the **A2A** case and **GSHP** case the peak load is reduced by 20 % and 9% respectively. Operational details are presented in Fig. F.1 to Fig. F.3, and are examined more closely in the following.

The figures describing the cases have three plots that show, (from top to bottom) the indoor temperature, heat generated and electricity imported from the grid. For comparison, the variables of the non-flexible cases *nf* (indoor temperature  $T_t^{\text{in,noflex}}$ , inflexible heat demand  $D^{\text{SH}}$  and electricity import  $y_t^{\text{imp,noflex}}$ ) are included in all plots. Note that  $y_t^{\text{imp}}$  is the sum of electricity imported for all building loads (see Eq. (F.37)). Hence it can be both smaller and larger than  $D^{\text{SH}}$ , depending on the coincidence of the loads  $\{D^{\text{SH}}, D^{\text{SH}}, D^{\text{DHW}}\}$  and the efficiency of the base load technology.

Fig. F.1 shows the operation of the heating system of the **DIR** case in a winter week, with significant spikes in the spot price  $P^{\text{spot}}$  (grey line) and low outdoor temperatures. The middle plot show that the panel ovens ( $q_{PO,t}^{\text{SH}}$ ) are operated to avoid the price spikes. The upper plot shows that due to this, the building is overheated in the first two-three days, and particularly in the hours preceding a spike in the spot price. Since these spikes occur in the morning and evening, a significant part of the overheating must take place at night. Whether this is acceptable for the end-user is outside the scope of this work. In addition, it is not possible to separate out the bedroom temperature from the aggregate dynamics represented by the average indoor temperature  $T_t^{\text{in}}$ .

From Table F.8 in column **DIR**, the annual peak load is reduced by 5 kW, a 6.25 % decrease, in **DIR-flx** compared to **DIR-nf**. Note that this decrease comes without any incentive (e.g. a penalty) for minimizing the peak load, but is achieved only through minimizing the total cost. Both the investment and operational costs are reduced marginally, yielding a 0.8 % decrease in the total cost. The annual imported electricity is increased by  $\sim 1$  MWh/yr compared to **DIR-nf**. This quantity corresponds to the losses incurred when storing heat in the thermal mass of the building.

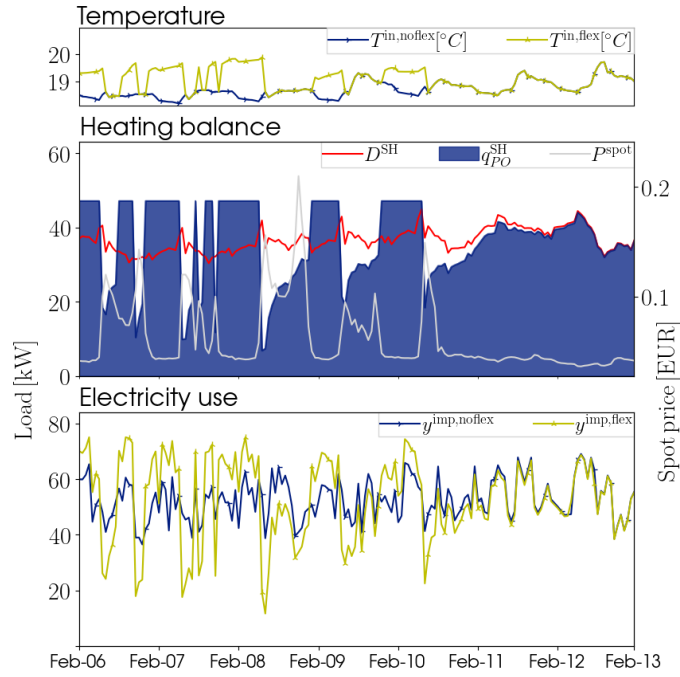

Figure F.1: Operational details of the **DIR-flex** case, week no.6.

The operation of the **A2A** case is plotted in Fig. F.2. The same trend as in the **DIR** case can be seen, with the overheating being utilized to some degree before high-price hours. However, the tendency is less pronounced, as the optimizer prefers running the A2A heat pump steadily at full power, only modulating the heat from the panel ovens, which reduces the need of top-up heat from the panel ovens,  $q_{PO}^{SH}$ . The peak load for the year is reduced by 16 kW, or 20 %.

The last case **GSHP** is shown in Fig. F.3. A significant difference from the previous two cases is the presence of a waterborne heating system. Hence, the heat pump GSHP and the top-up boiler supply both the space heating ( $D^{SH}$ ) and domestic hot water ( $D^{DHW}$ ) demand. However, only  $D^{SH}$  is shown in Fig. F.3, since the focus of the paper is flexibility from space heating. The tendency towards overheating is similar to the **A2A** case, but the heat generated from the GSHP is used more flexible than the A2A HP. We find that this is because the GSHP's capacity is used for both SH and DHW demand, and when utilising the thermal flexibility of the building, the use of the top-up boiler can be reduced for both SH and DHW demand, by allocating GSHP capacity for the DHW demand and reducing it for SH demand. The peak load is reduced by  $\sim 4$  kW, or 9 %, which is less than for the A2A case, due to the higher system efficiency of the GSHP case.

## Discussion

The utilisation of the thermal mass of the building is in this paper incentivised by the variations of the spot price. However, it is uncertain whether the cost reduction achieved by

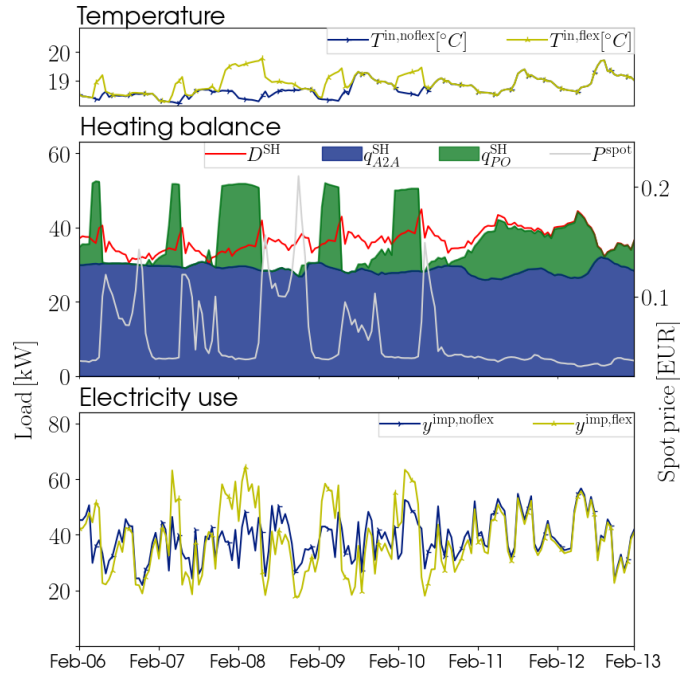

Figure F.2: Operational details of the **A2A-flx** case, week 6.

this activation is large enough to warrant the investment cost of the hardware required for the implementation of a smart control strategy, such as MPC, which can enable demand-side management and hence "predictive overheating" in a real-time setting. This can change in two distinct ways: either the spot price variability increases, or the business models for energy services at the end-user level are changed to better reflect the needs of the system. E.g. a controller at this end-user level can be rewarded for reducing the grid impact, where the reward is reflected by the situation in the grid.

Further, the assumption of "full"-horizon and perfect knowledge for the operational part of the problem, in the sense that the optimizer sees all disturbances for the whole year with perfect knowledge, makes it optimal to overheat as far ahead as several days before a peak-price event. This might not be feasible in reality, as the increased computational burden entailed by a long prediction horizon would render MPC infeasible in many cases (as most optimal control problems increase ca. cubically in computational complexity with horizon length [16]). In addition, real-time predictions are not perfect. Thus, from the practical control perspective, the flexibility potential in this paper is overestimated. However, the baseline, as it is calibrated and found in Section F.5.3, is very restrictive. It does not take into account factors such as occupancy, night setback and different thermal zones (e.g. with the indoor temperature being represented by the average,  $T^{\text{in}}$ ). Thus, from a modelling perspective, the flexibility potential might as well be underestimated.

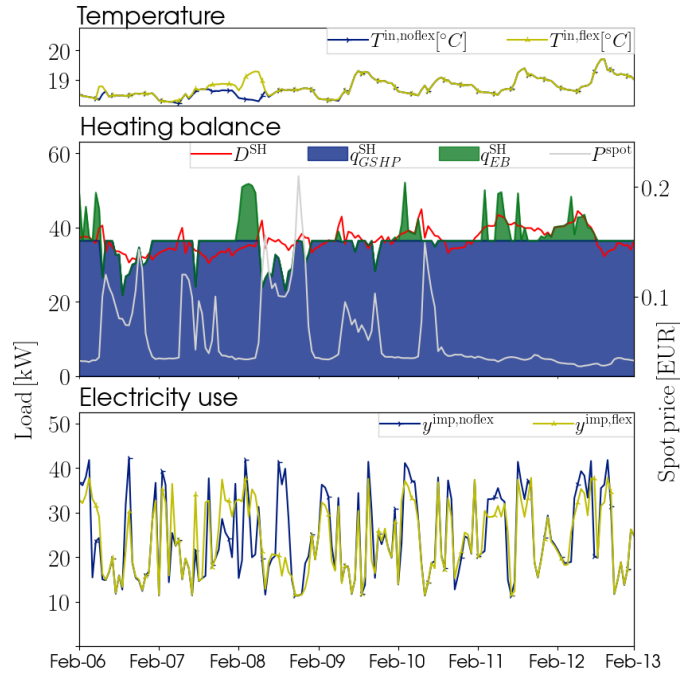

Figure F.3: Operational details of the **GSHP-flex** case, week 6.

## Conclusion

In this paper a grey-box structure has been implemented in a building design optimization tool, BUTLER, to investigate the flexibility potential of the thermal mass of a building. It has been shown that by utilizing the building thermal mass, in this paper defined as *comfort flexibility*, a reduction in the peak space heating load can be achieved by overheating and thereafter curtailing the heat generated from the peak load technologies. The annual operational costs are not affected significantly by the activation of this flexibility.

It has been shown that the largest percentage-wise reduction of the total electric peak load of the building is observed in the cases with heat pumps as the base load technology, since the less energy-efficient heat generation, like panel ovens and electric boilers, can be curtailed in the peak price hours, which also coincide with the peak load hours.

## F.6.2 EV Results

Since the investment option is equal in all cases, this section focuses on BUTLER's operational results of the five use cases. The non-flexible charging in the baseline **BASE** is represented by a green line in all plots, such that comparisons easily can be made between the respective cases and the baseline.

Figure F.4 shows a week of hourly operations for the case of minimum cost optimization. The upper plot shows the power used for EV-charging, with the green  $D_{EV}^{\text{base}}$  the baseline case **BASE** and the blue  $y_{EV}^{\text{flex}}$  denoting the flexible case **EP**. With the minimum cost strategy in

Fig. F.4, the optimizer becomes very sensitive to relatively small variations in the spot price. E.g. on Dec 4<sup>th</sup> the baseline charging  $D_{EV}^{base}$  has a peak load of just below 30 kW. With flexible charging the charging pattern is shifted towards midnight, creating a peak of almost 50 kW. The same change of charging pattern seems to apply for the other days. This load shifting takes place despite the difference in spot price,  $P^{spot}$  (grey line), being small.

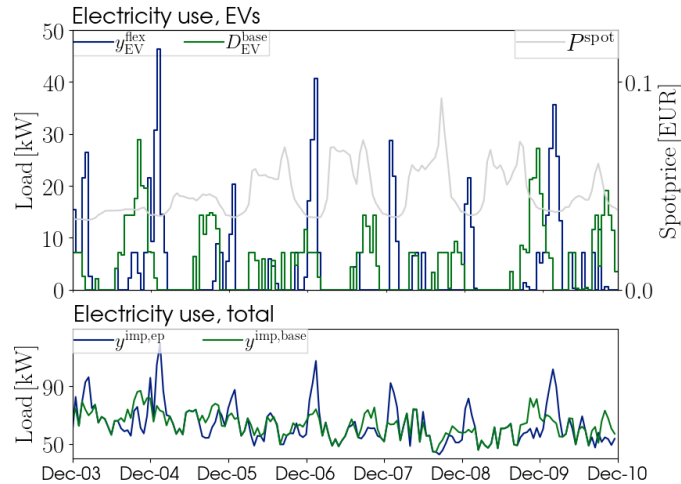

Figure F.4: Energy pricing (EP), week 49.

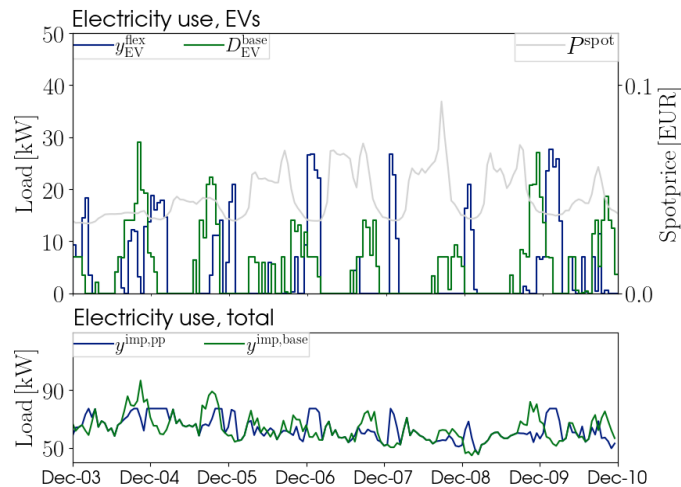

Figure F.5: Peak power monthly (PPM), week 49.

The lower plot in Fig. F.4 shows the total electricity import/use of the building (including all loads), with the same coloring as the upper plot. Here, the peaks of the total electricity use,  $y^{imp}$ , is shifted and magnified significantly during nighttime, from 87 kW in **BASE** to 125 kW in **EP** (cf. Table F.8). In situations where the grid is less constrained, this effect may not present a problem. However, we can imagine that a situation in which several apartment blocks (each similar to the archetype we are studying) are pursuing minimum cost strategies (with energy pricing as the grid tariff), could lead to new peak loads and congestions in the local grid.

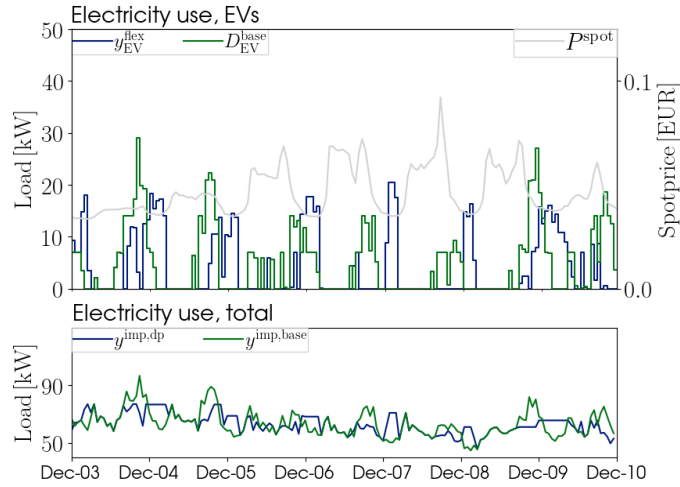

Figure F.6: Peak power daily (**PPD**), week 49.

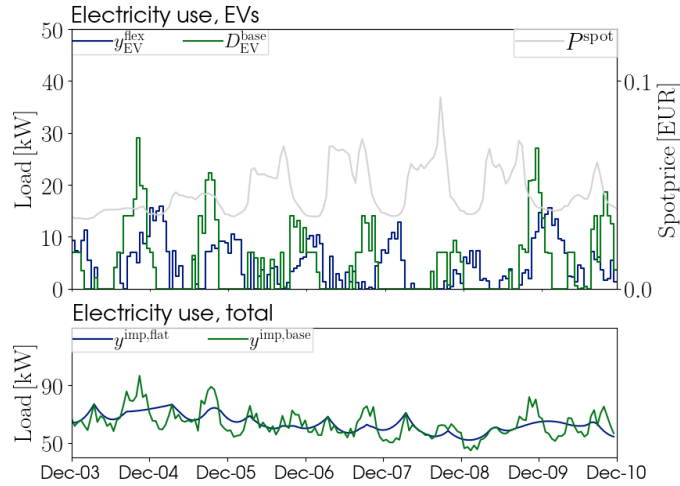

Figure F.7: "Import flattening" (**FLAT**), week 49.

The next case is the monthly peak power optimizer (**PPM**) which minimises cost and includes a penalty on the monthly peak power load (see Eq. F.28). Fig. F.5 shows that this objective yields charging events to shift to the same hours (late evening) as in the **EP** case, but with a much lower peak load for the charging  $y_{EV}^{flex}$ . This is due to the penalty imposed on the monthly peak load, which incentivizes the optimizer to keep the import below a certain level for the month, and hence spread out charging in accordance with the availability  $\Lambda_{v,t}^{EV}$  for each  $v \in \mathcal{V}$ . The impact on the total use of electricity can be seen in the lower plot, where the peak load of the total building, including EV charging, is reduced by 16 kW (18%) compared to the baseline.

The third case is the daily peak power optimizer **PPD**, seen in Fig. F.6. The general pattern is much the same as in the case with monthly peak power **PPM**, but with somewhat more on-off behaviour. This can be explained by the daily peak structure incentivising peak reductions and load shifting every day. Whereas the **PPM** case is only incentivised to keep the peak

below the monthly peak, which in this case is a time step where the energy (power) use is dominated by heating  $\{D^{\text{SH}}, D^{\text{DHW}}\}$  and specific el  $D^{\text{EL}}$ . For the daily peak case **PPD**, we see a reduction in the total peak  $y^{\text{imp}}$  of about the same magnitude as in **PPM**.

Table F.8: Annual peak load, and annual operational costs.

<b>KPIs</b>	<b>BASE</b>	<b>EP</b>	<b>PPM</b>	<b>PPD</b>	<b>FLAT</b>
Peak load [kW]	86.9	124.6	70.9	71.2	71.2
compared to BASE	-	43.3%	-18.4%	-18.1%	-18.1%
Oper. costs [kEUR/yr]	41.60	41.44	39.15	35.93	41.64
compared to BASE	-	-0.4%	-5.9%	-13.6%	0.1%

Finally, we have the multi-objective case **FLAT**, where a smoothing objective in Eq. F.32 is added to the objective function in Eq. F.1. The grid tariff used is regular energy pricing. Here, the charging is also more evenly distributed throughout the day and week. However, instead of the more nervous behaviour as exhibited in **PPD**, the charging pattern in **FLAT** resembles a standing sine-wave, with the amplitude proportional to the variation in the spot price. This is a consequence of the part of the objective function represented by Eq. (F.32) acting as a low-pass filter between  $P^{\text{spot}}$  and  $y^{\text{imp}}$ .

It should be mentioned that both weighing factors  $\lambda_1, \lambda_2$  in the modified objective function (Eq. (F.33)) are set to 1 for simplicity. A more involved approach to the multi-objective, i.e. finding these weights, is to seek a Pareto-front [?]. However, this would require an estimate for the (discounted) value of the peak reduction from the side of the grid operator, which we do not have at the moment.

## Discussion and Further work

The results show that the peak load of an apartment block can be significantly reduced if the right incentive is in place. This can be achieved by applying peak power tariffs (daily or monthly), which are static signals, or in the simplest way applying a multi-objective to smoothen out the load profile of electricity import. Although the **FLAT** case provides a simple algorithm for reducing peak loads, it increases the operational costs as the smoothening tends to be stronger than the cost minimisation avoiding hours of high electricity prices. This is in contrast to the peak power grid tariff cases, **PPM** and **PPD**, who both are able to reduce their operational costs, although they are not directly comparable in cost structure due to the non-calibrated parameters of the respective grid tariffs.

What seems to be the least ideal case from the perspective of the power grid, is the combination of optimal control with the current energy pricing grid tariff (as in **EP**). This shifts charging of all EVs to hours with the lowest spot market price, with correspondingly magnified peaks.



Hence, we can conclude that the spot price in itself might not be a sufficient price signal for optimal control of flexible EV-charging.

## **Conclusion**

A novel approach for evaluating the flexibility potential of flexible EV-charging has been presented, using data from real world charging reports [8]. The method is able to utilise the idle capacity of the EVs when plugged in. In this way the peak load of the total building can be reduced rather than increased - which is often the case when applying home charging. Several strategies for minimizing both cost and peak load have been tested. It is shown that a cost minimization in combination with an energy pricing grid tariff creates larger peaks than the reference case, which is unfortunate from the perspective of the grid. Three alternatives to the strict minimum cost/energy pricing optimization gave about the same benefit in terms of peak load reduction. The results confirm that EV-charging represents a large source of flexibility from the perspective of the system operator, as long as there is incentive for the end-user to act in accordance with system-level objectives.

# Bibliography

- [1] K. B. Lindberg, G. Doorman, D. Fischer, M. Korpås, A. Ånestad, and I. Sartori, “Methodology for optimal energy system design of Zero Energy Buildings using mixed-integer linear programming,” *Energy and Buildings*, vol. 127, pp. 194–205, sep 2016.
- [2] W. E. Hart, C. D. Laird, J.-P. Watson, D. L. Woodruff, G. A. Hackebeil, B. L. Nicholson, and J. D. Siirola, *Pyomo—optimization modeling in python*, 2nd ed. Springer Science & Business Media, 2017, vol. 67.
- [3] M. Bagle, “Investigation into the impact of thermal energy flexibility on cost optimal design and operation of Zero Emission Buildings,” Master thesis, 2019.
- [4] N. R. Kristensen and H. Madsen, *Continuous time stochastic modelling - Math Guide*, 2003.
- [5] C. Van Loan, “Computing integrals involving the matrix exponential,” *IEEE Transactions on Automatic Control*, vol. 23, no. 3, pp. 395–404, 1978.
- [6] M. E. Bagle, P. Maree, H. T. Walnum, and I. Sartori, “Identifying grey-box models from archetypes of apartment block buildings (submitted),” *Building Simulation Conference*, sep 2021.
- [7] “Oso hotwater,” <https://www.osohotwater.no/no-nb/commercial/maxi-standard>, (Accessed on 05/06/2021).
- [8] Å. L. Sørensen, K. B. Lindberg, I. Sartori, and I. Andresen, “Residential electric vehicle charging datasets from apartment buildings,” *Data in Brief*, p. 107105, apr 2021. [Online]. Available: <https://linkinghub.elsevier.com/retrieve/pii/S2352340921003899>
- [9] —, “Residential electric vehicle charging datasets from apartment buildings,” *Data in Brief*, p. 107105, apr 2021. [Online]. Available: <https://linkinghub.elsevier.com/retrieve/pii/S2352340921003899>

- [10] K. B. Lindberg, S. J. Bakker, and I. Sartori, "Modelling electric and heat load profiles of non-residential buildings for use in long-term aggregate load forecasts," *Utilities Policy*, vol. 58, pp. 63–88, 2019.
- [11] K. H. Andersen, S. K. Lien, H. T. Walnum, K. B. Lindberg, and I. Sartori, "Further development and validation of the "PROFet" energy demand load profiles estimator," (submitted to) *Building Simulation 2021 Conference, 1-3 Sep., Bruges, Belgium (Build-Sim)*, sep 2021.
- [12] Ø. Rønneseth and I. Sartori, "Possibilities for Supplying Norwegian Apartment Blocks With 4 Th Generation District Heating," Research Centre on Zero Emission Neighbourhoods in Smart Cities, Tech. Rep. 8, 2018.
- [13] NVE; SSB, *Oppvarming i boliger - Kartlegging av oppvarmingsutstyr og effektiviseringstiltak i husholdningene [Norwegian]*. NVE, 2014. [Online]. Available: [http://publikasjoner.nve.no/rapport/2014/rapport2014\\_85.pdf](http://publikasjoner.nve.no/rapport/2014/rapport2014_85.pdf)
- [14] Standard Norge, "Calculation of energy performance of buildings - Method and data," 2014. [Online]. Available: <https://www.standard.no/no/Nettbutikk/produktkatalogen/Produktpresentasjon/?ProductID=70>
- [15] N. Elbilforening;, "Elbilbestand." [Online]. Available: <https://elbil.no/elbilstatistikk/elbilbestand/>
- [16] J. Drgoňa, J. Arroyo, I. Cupeiro Figueroa, D. Blum, K. Arendt, D. Kim, E. P. Ollé, J. Oravec, M. Wetter, D. L. Vrabie, and L. Helsen, "All you need to know about model predictive control for buildings," sep 2020.

# Flexbuild Annual Report 2

## TECHNICAL REPORT WITH RESULTS ANALYSIS

This is the second annual report from the FlexBuild research project – a knowledge-building project for industry co-financed by the Research Council of Norway under the programme EnergiX. The report summarises the main findings from the executed research work within the project's second year.

The FlexBuild project will estimate the cost-optimal implementation of end-user flexibility from a socio-economic perspective. The results will quantify the effect of end-user flexibility on electricity consumption in individual buildings, but also on the aggregated national level. What is new in FlexBuild is that the value of end-user flexibility will be analyzed from a system perspective, with a solid stochastic modelling and detailed representation of the building sector. FlexBuild responds to knowledge gaps that have been identified by several actors, both from the supply side (power grid and district heating companies) to the end-user side (building owners) and public actors.