



Institute for Energy Technology

Research for a better future



Renewable
energy



Nuclear
technology



Materials
technology



Digitalization



Radiopharmacy
and health



Oil and gas



Industry and
environment



Safety and
security

CONVERGE: CarbON Valorisation in Energy-efficient Green fuels

SER and SEWGS for CO₂ capture: preliminary experimental results

International Workshop on CO₂ capture and Utilization – February 17th 2021

CONVERGE WP3: Objectives

The main objective of WP3 is to validate the integration of the SER and EHC technologies at TRL5 in relevant operating conditions adapted to the CONVERGE concept with the following specific targets:

- Reduce the energy consumption for hydrogen production, CO₂ removal and compression to 1.2 MJ/kg CO₂
 - **Optimization of the CO₂ sorbent material used in the SER process**
 - **Development of new improved catalytic materials suited for the CONVERGE syngas**
- Extract and compress H₂ at >99.5% purity, 50 bar and at a primary energy consumption of 12 MJ/kg H₂
- Operate the SER and EHC for 500 hours on C1-C6 containing emulated syngas feed at 10 Nm³/hr H₂ production

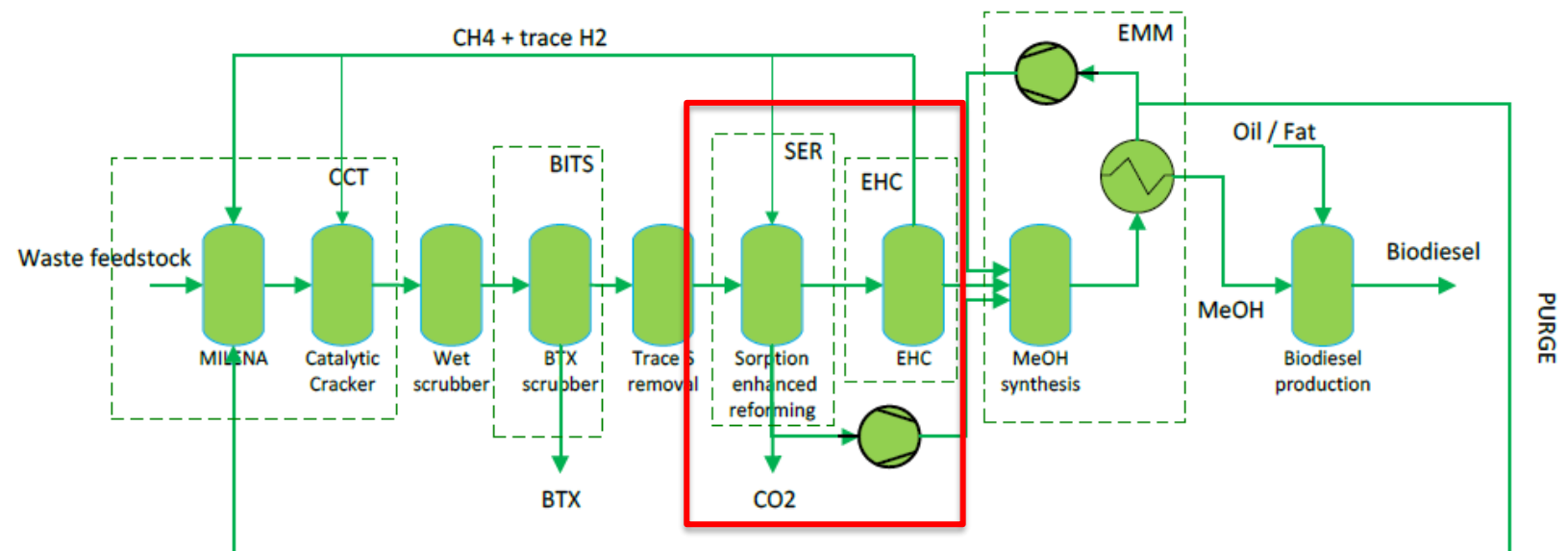

Sorption Enhanced reforming (SER)

SER integrates Reforming, Water-Gas Shift (WGS) and CO₂ separation through the addition of a high temperature CaO-based CO₂ solid sorbent

SER Concept scheme

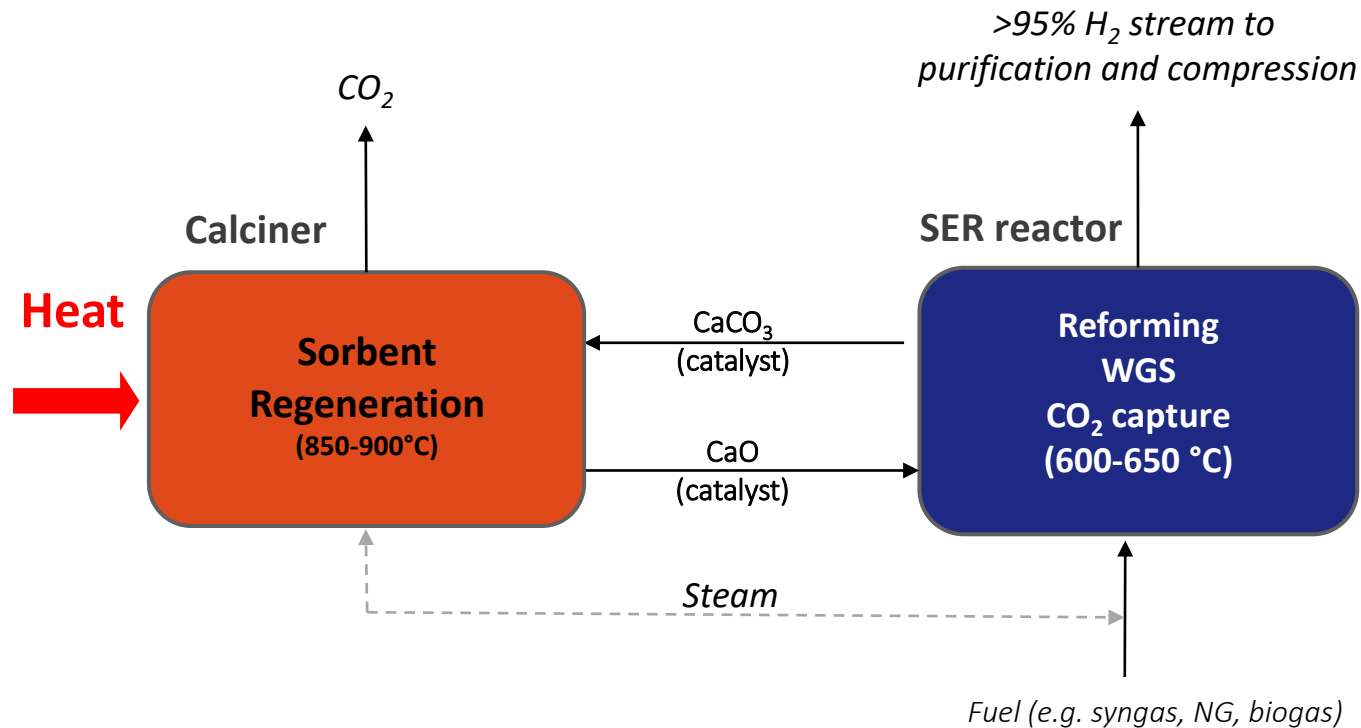

Feed Gas after CCT

- H₂ - 41.9%
- CO - 10.0%
- CO₂ - 32.4%
- CH₄ - 10.5%
- C₂H₄ - 4.4%
- N₂ - 0.9%

SER reactor technology developed at IFE

Dual Bubbling Fluidized Bed (DBFB) reactor system

- Dual bubbling fluidized bed reactor (DBFB)
 - 2 FB-reactors coupled with loop-seals and riser
 - Continuous mode
 - Bubbling regime
 - Circulation rate adjusted with slide valve

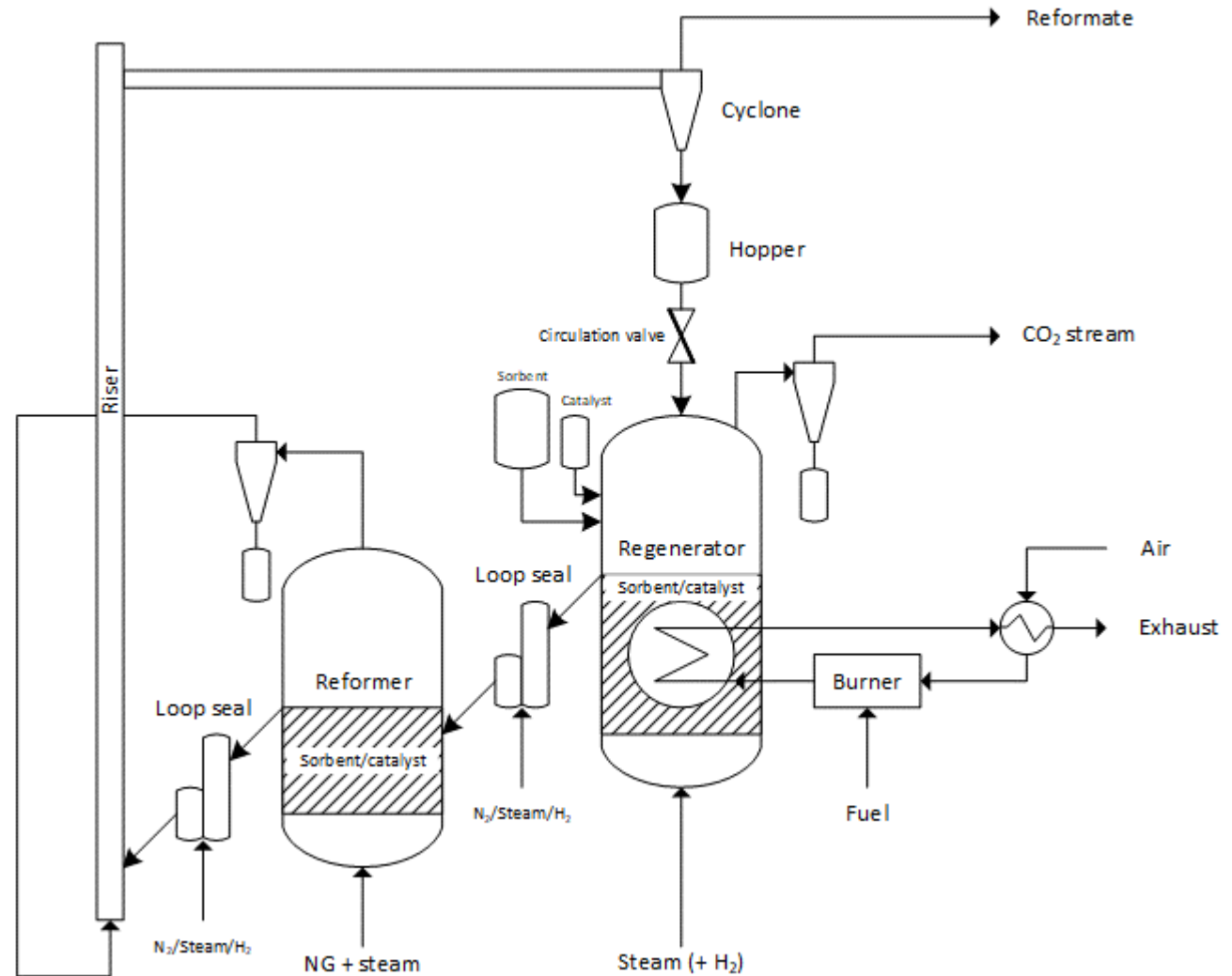

Materials Development and Optimization

CO₂ sorbent material used in the SER process

- added a thermally stable dopant (ZrO₂, MgO and Fe₂O₃) in the CaO/Mayenite sorbent to increase its stability

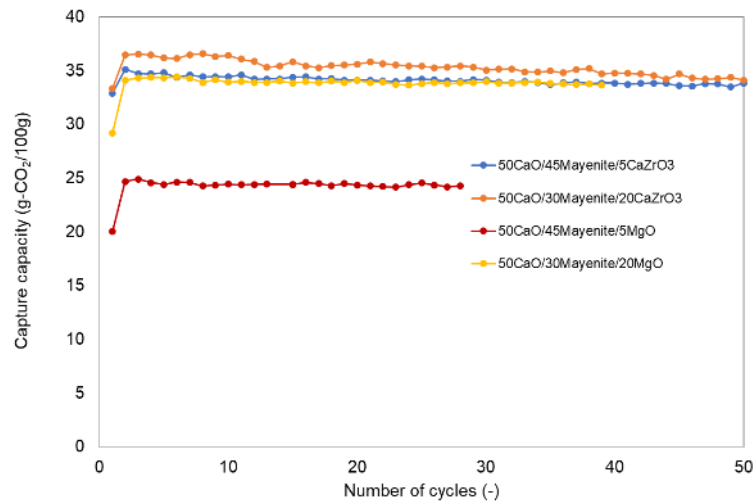

Sorbent powders: stable activity and capacity target achieved in some cases

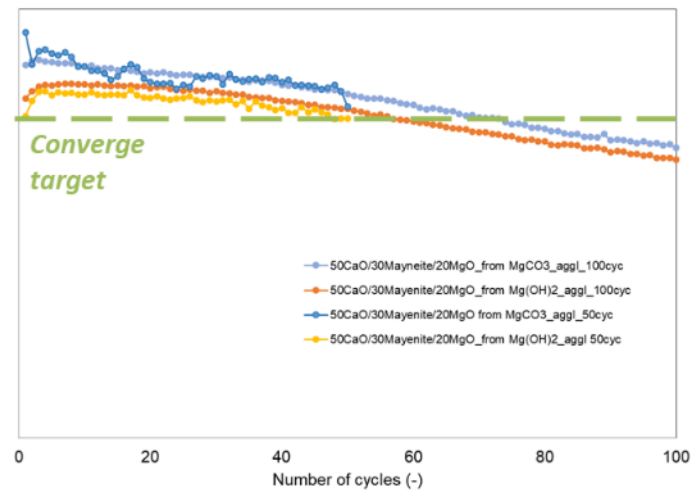

100 cycles test: capacity decreases more severely. The addition of thermally stable agents does not allow reaching the target

- HTSORB – Chosen for experiments

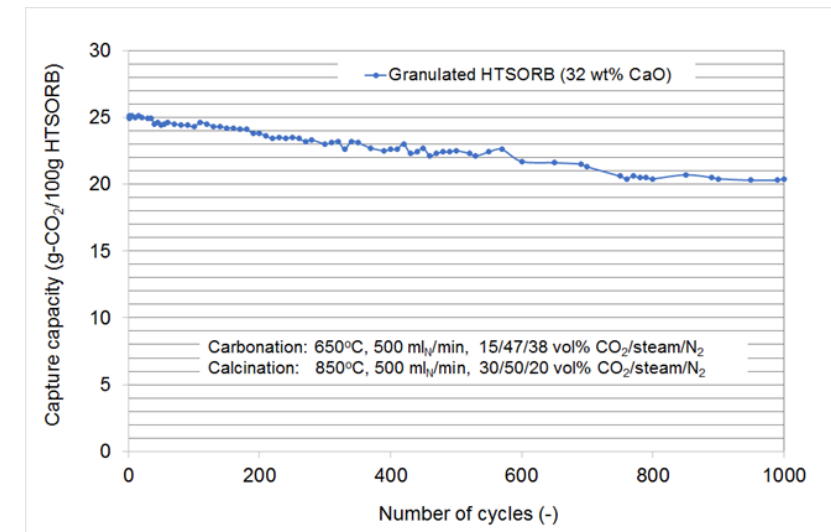

Long-term sorption capacity: stabilized at < 20 g-CO₂/100g sorbent after 1000 carbonation-calcination cycles

Development of catalyst tailored for SER process– Stability test

SER Catalyst testing and aging

- New catalytic set-up designed and constructed within CONVERGE project for “stability” and “kinetic” tests.

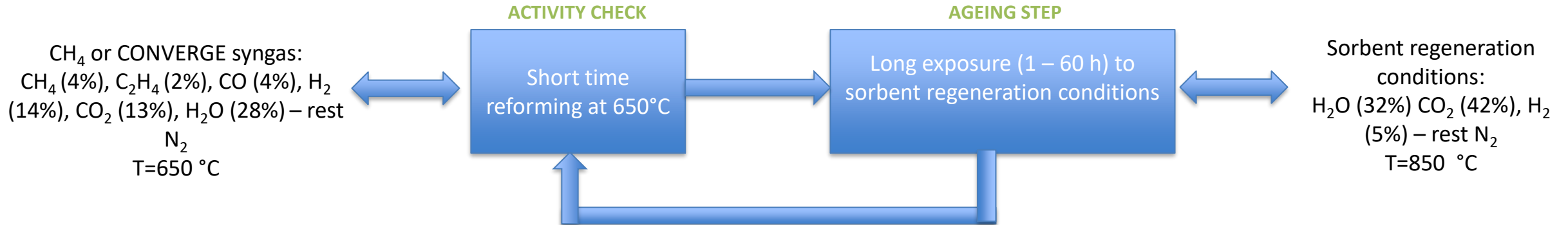

Development of catalyst tailored for SER process– Stability test

SER Catalyst testing and aging

- New catalytic set-up designed and constructed within CONVERGE project for “stability” and “kinetic” tests.

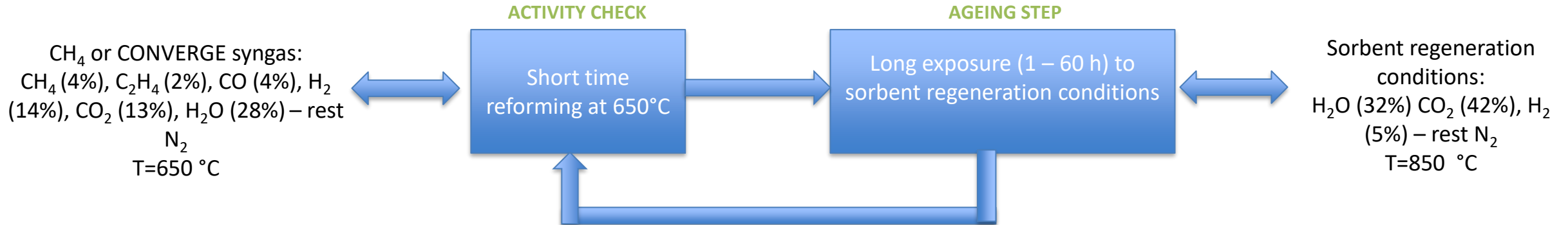

Materials Development and Optimization

Development of catalyst tailored for SER process – Stability test

Stability tests:

Screening a matrix of 15-20 newly synthesized materials

- 5 different supports
- 5-10-15-20 wt % Ni

Satisfactory results, higher activity than commercial reference for some of the prepared catalysts

SEM characterization after 60h of test:

- Nickel sintering well evident in the commercial catalyst
- No evidence of nickel sintering but total nickel loading to be decreased to avoid nickel «envelop» effect

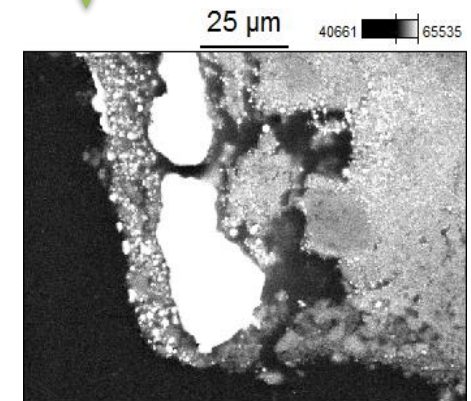
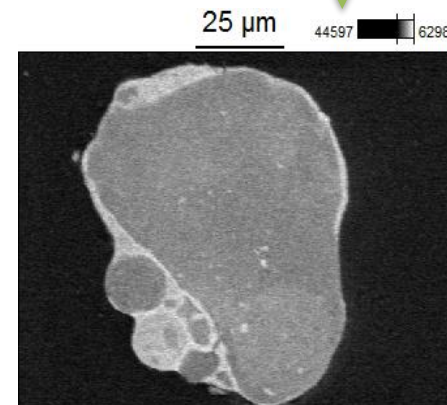
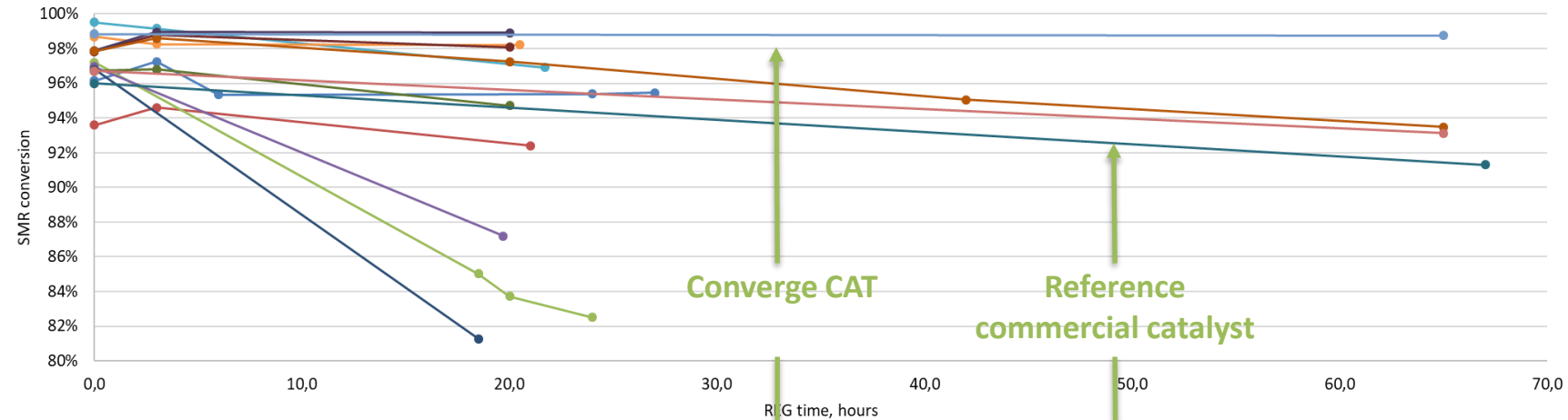

Materials Development and Optimization

Development of catalyst tailored for SER process– Stability test in SMR conditions (Aged 60h)

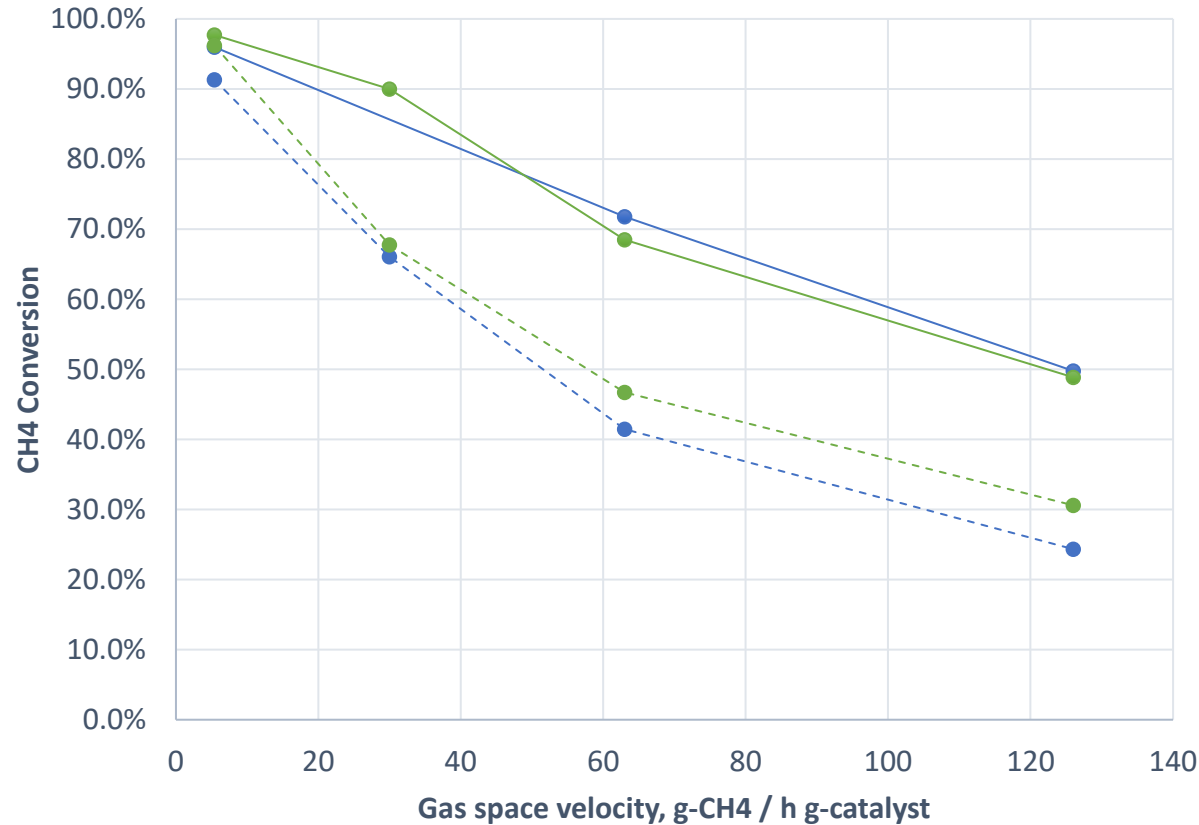

CH₄ conversion

- Converge CAT presents better CH₄ conversion after aging. Difference more apparent in higher GSV.

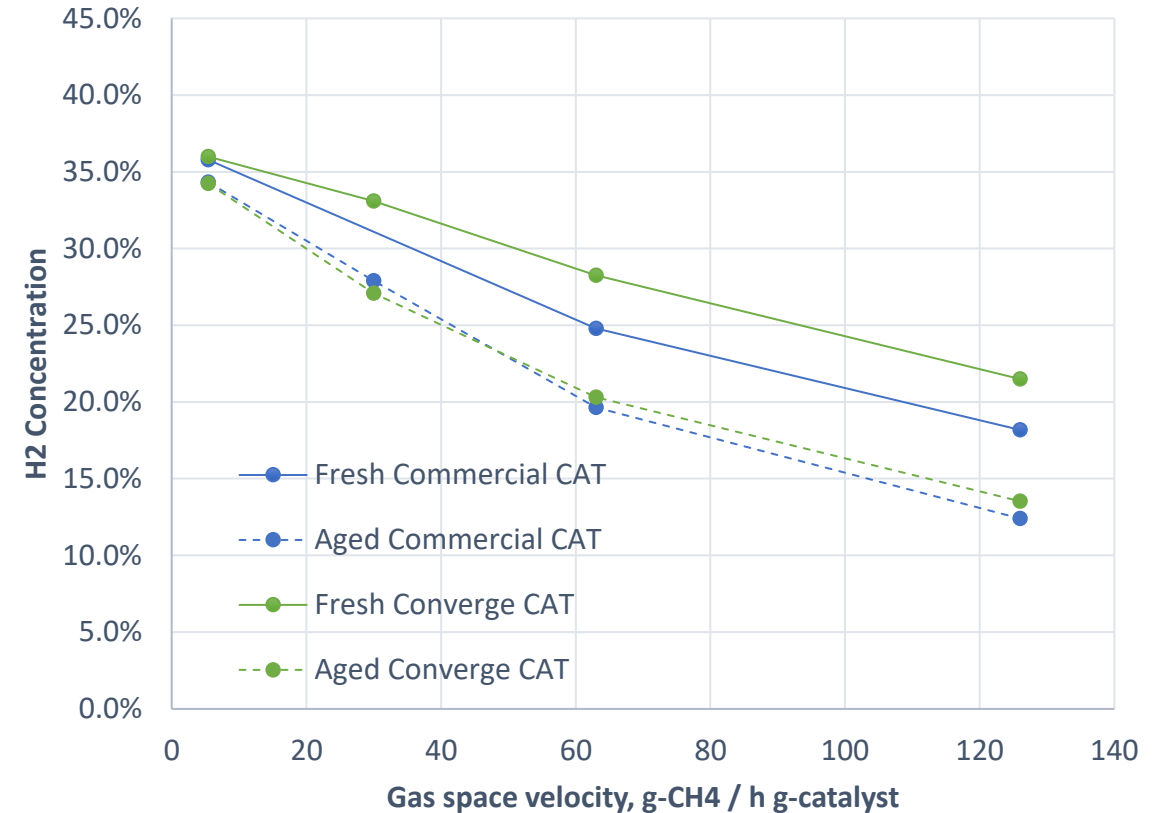

H₂ concentration

- Converge CAT presents better H₂ selectivity fresh and after aging

Materials Development and Optimization

Development of catalyst tailored for SER process– Stability test

Commercial CAT

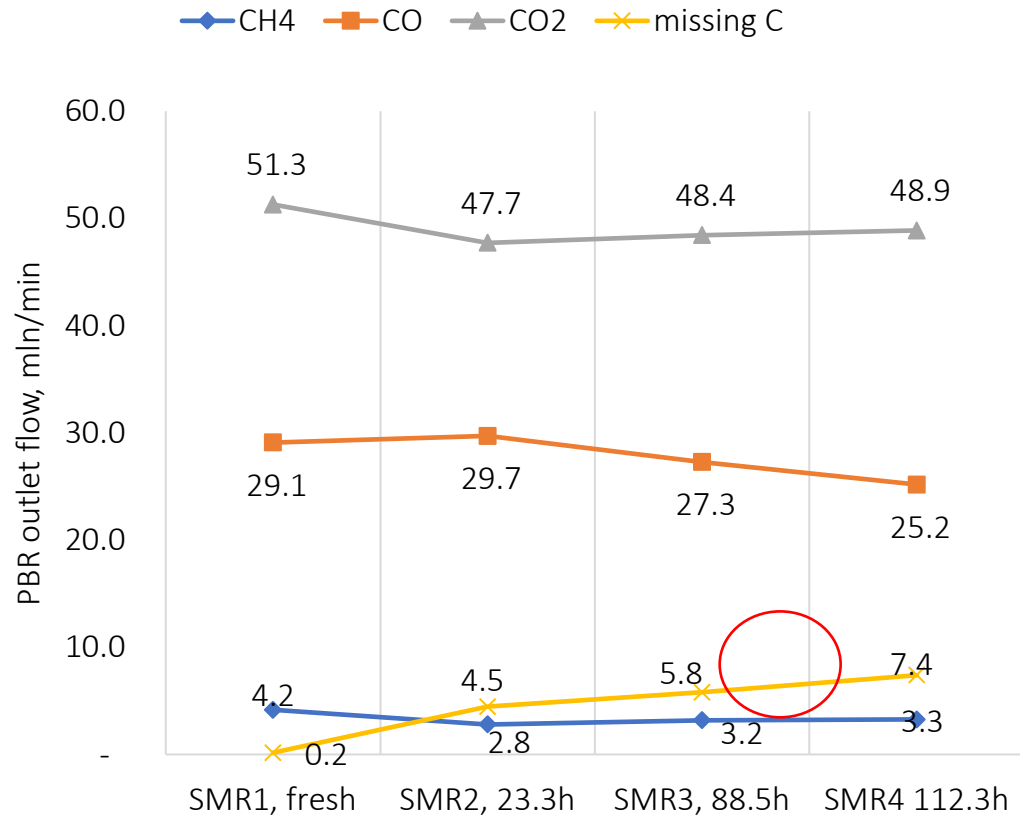

Converge CAT

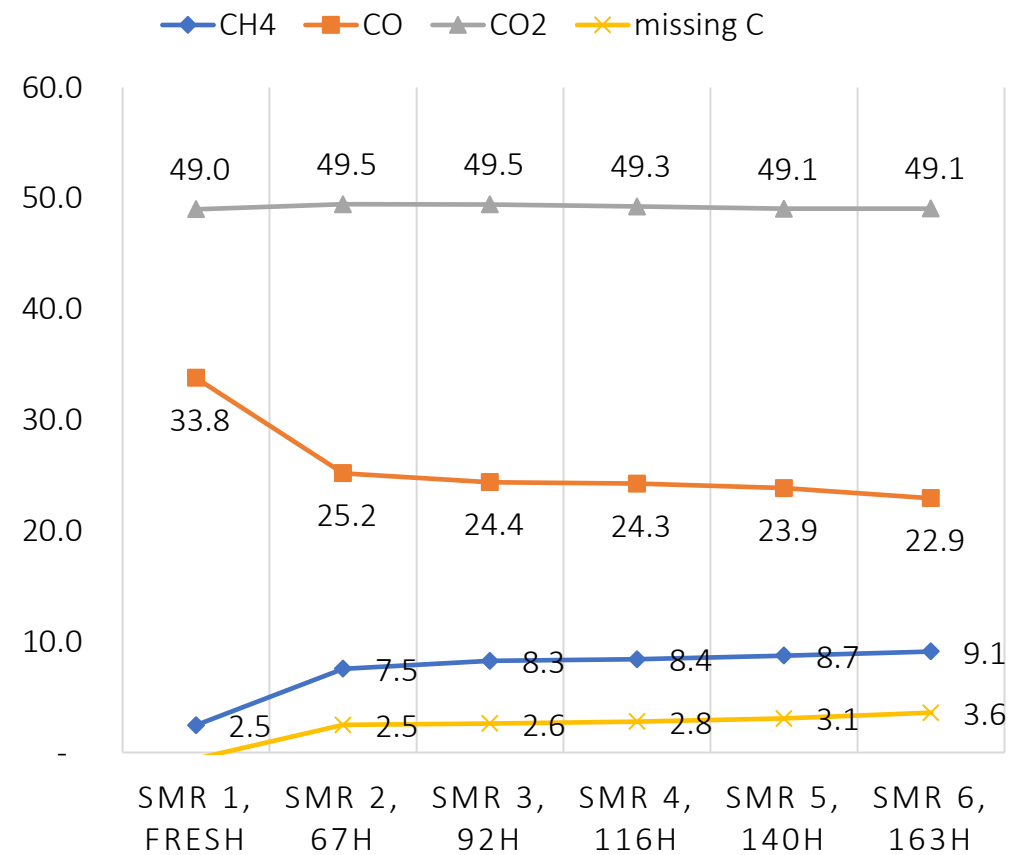

- Increase in carbon deposition. (TPO confirmed)
- Experiment stop after 120h aging – High pressure drop

- No carbon deposition
- Experiment stable during 160h aging

FBR Tests

SER/SEWGS – Equilibrium Trade-off

Process Parameters

Temperature: 650°C

Pressure: 0.5 barg

Fluidization velocity: 0.036 m/s

Feedstock and Materials

Gas Feed: (mol%): 41.9% H₂, 10.0% CO, 32.4% CO₂, 10.5% CH₄, 4.4% C₂H₄, 0.9% N₂

Steam R value: 2.0

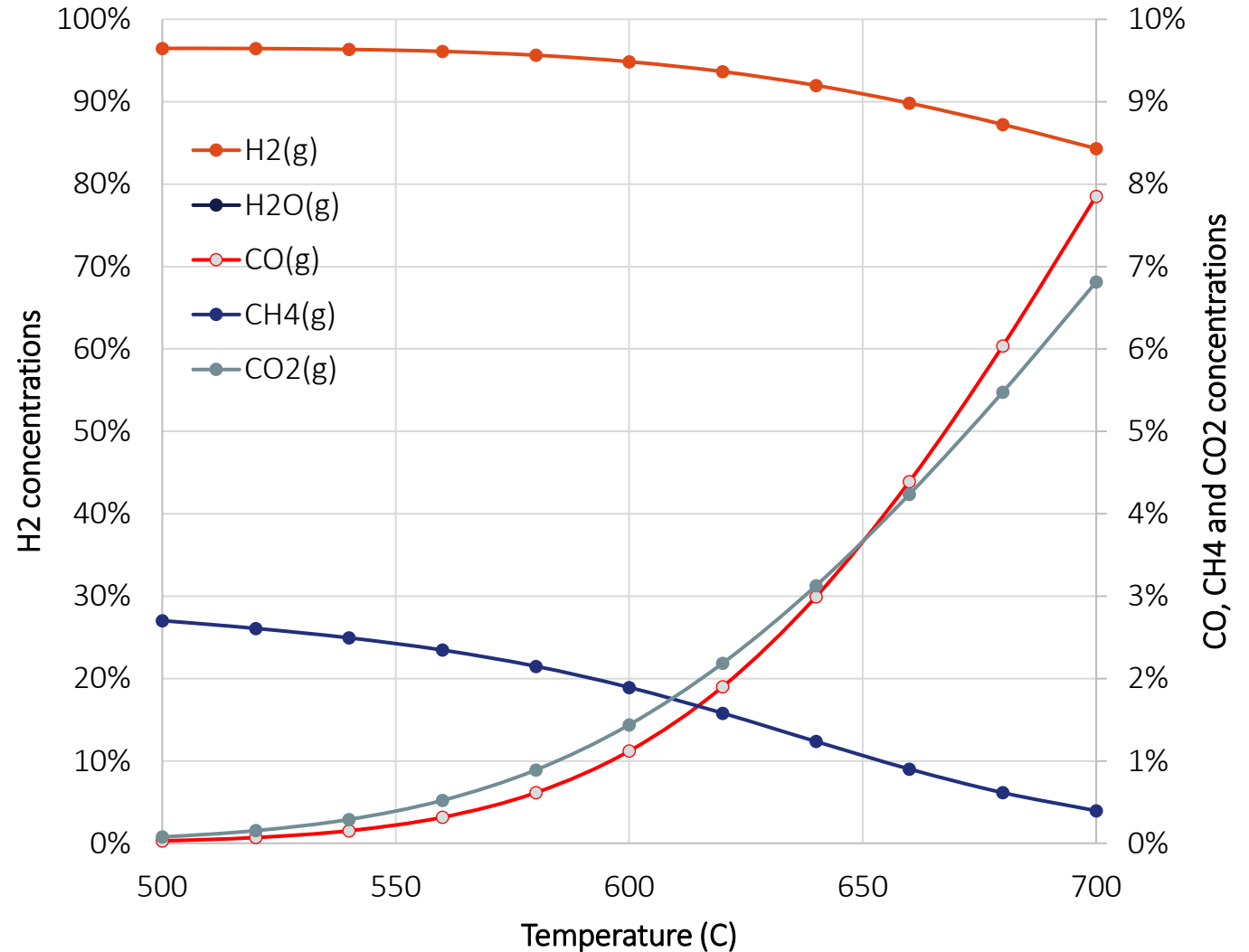

SER/SEWGS – With syngas - Converge Cat

Process Parameters

Temperature: 650°C

Pressure: 0.36 barg

Fluidization velocity: 0.05 m/s

Feedstock and Materials

Gas Feed: (mol%): 41.9% H₂, 10.0% CO, 32.4% CO₂, 10.5% CH₄, 4.4% C₂H₄, 0.9% N₂

Steam R value: 2.0

Materials: 120.7 g CaO sorbent + 12.5 g Converge Cat

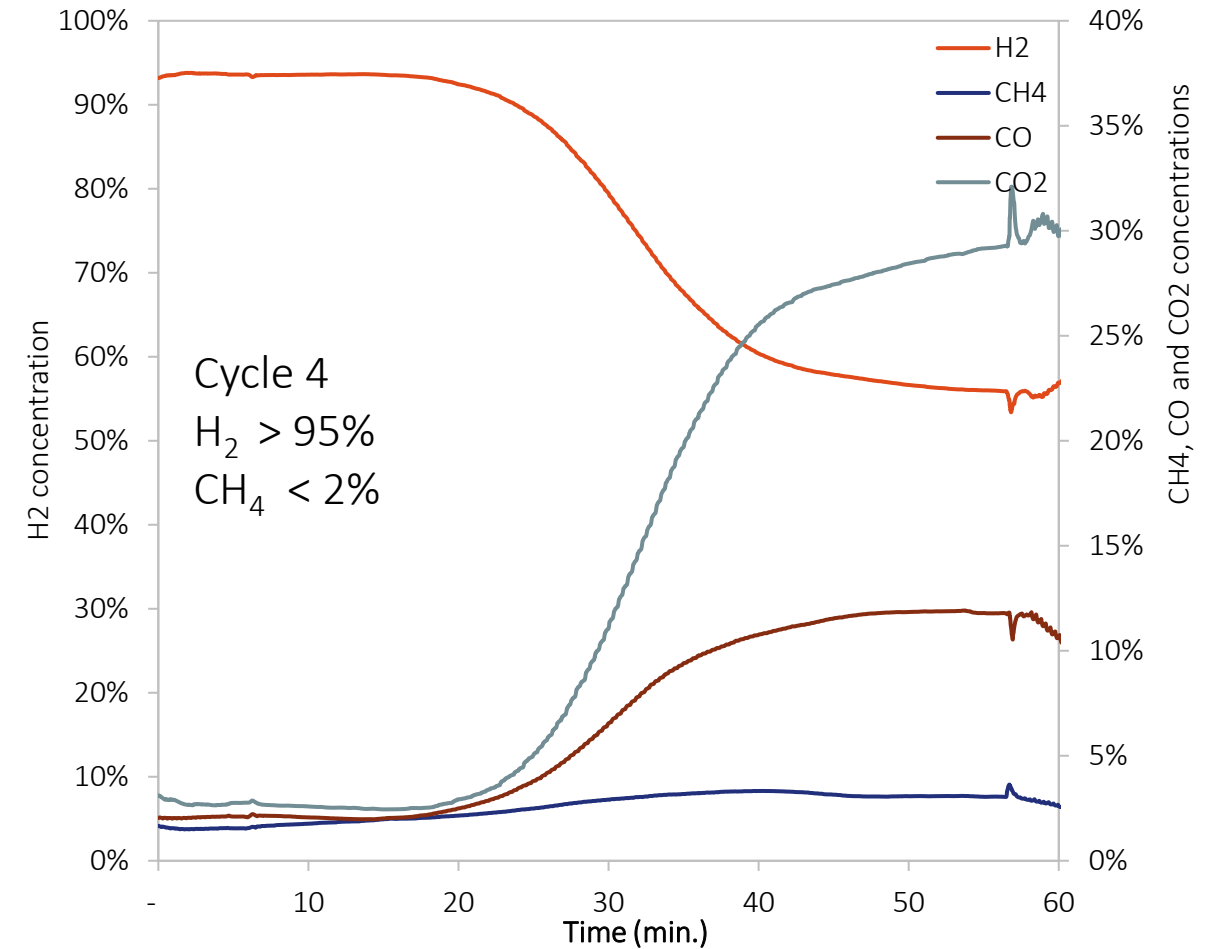
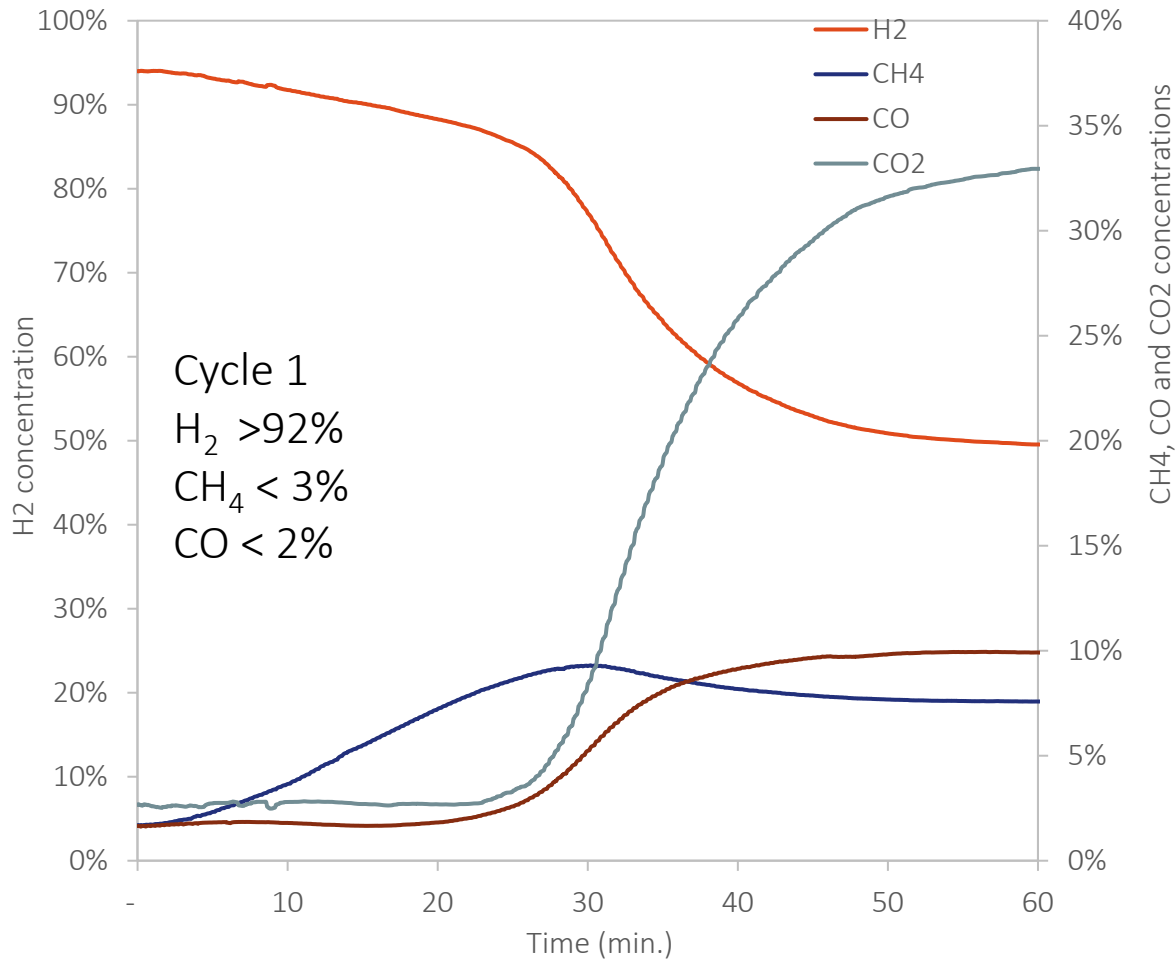

SER/SEWGS – With syngas and glycerol - Commercial Catalyst

Process Parameters

Temperature: 600°C

Pressure: 0.23 barg

Fluidization velocity: 0.053 m/s

Feedstock and Materials

Gas Feed: (mol%): 41.9% H₂, 10.0% CO, 32.4% CO₂, 10.5% CH₄, 4.4% C₂H₄, 0.9% N₂

Liquid Feed: glycerol 5% of gas feed

Steam R value: 2.0

Materials: 102 g CaO sorbent + 15.4 g Commercial Catalyst

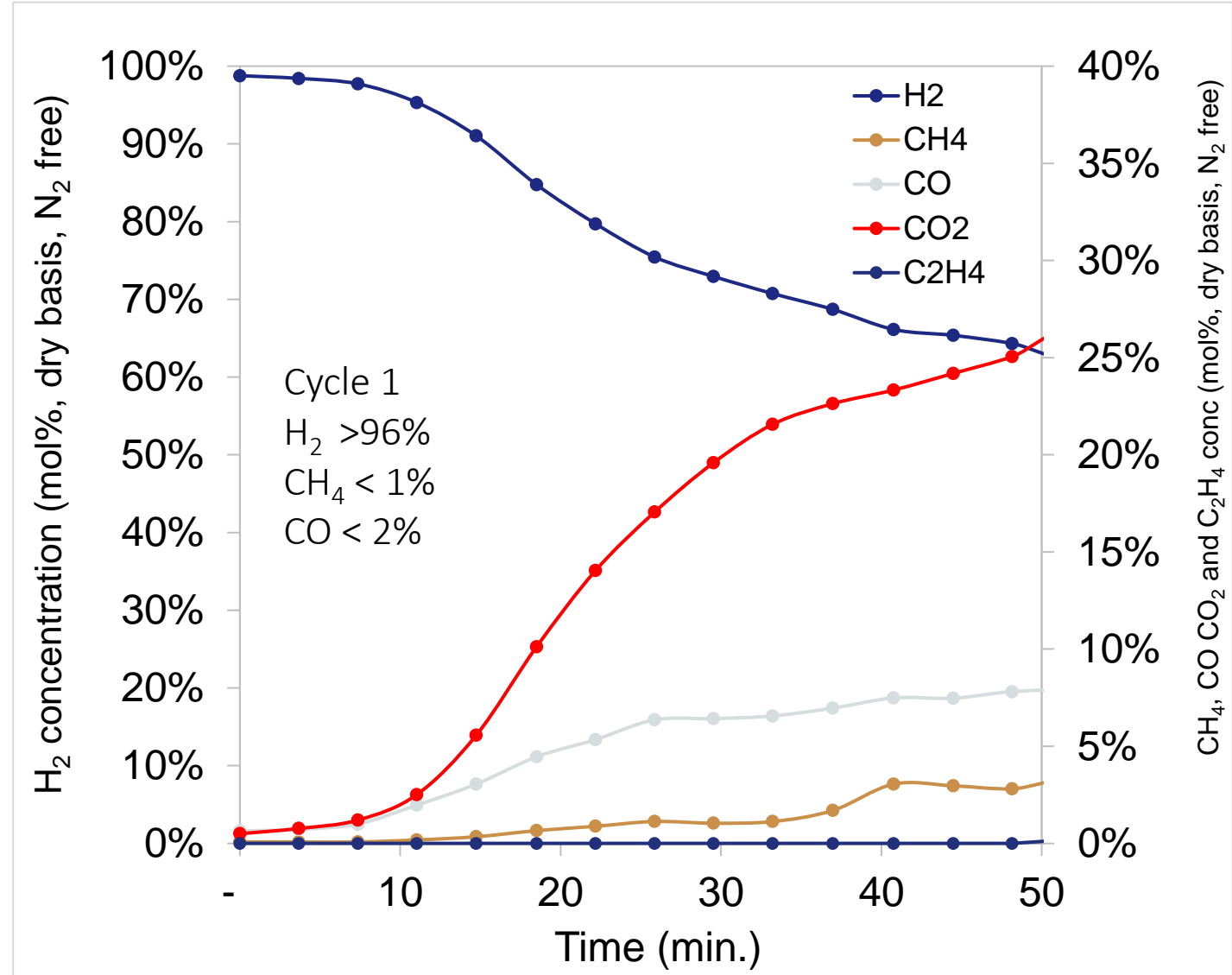

Next Steps

SER – EHC 500h demonstration at the IFE-HyNor Hydrogen Technology Center, Norway



IFE

Beyond CONVERGE

Bio4Fuels - Green Hydrogen from Biogas

Sorption Enhanced Reforming - SER

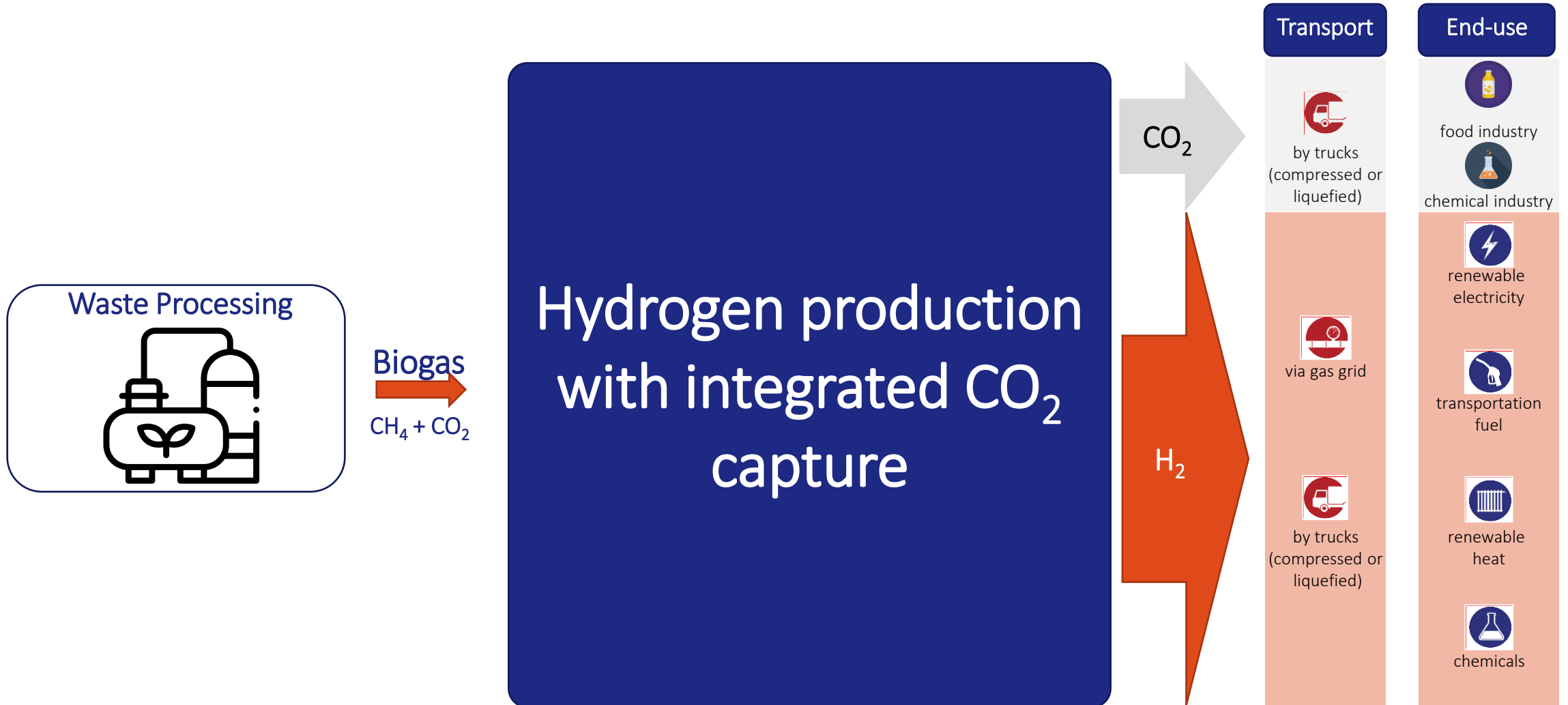

Biogas Upgrading - SER in Numbers

Conversion Efficiency

- H₂ yields (>98%) - for CH₄/CO₂ ratios varying between 1 and 2.33.
- CO₂ is over 98% pure.

Hydrogen Production

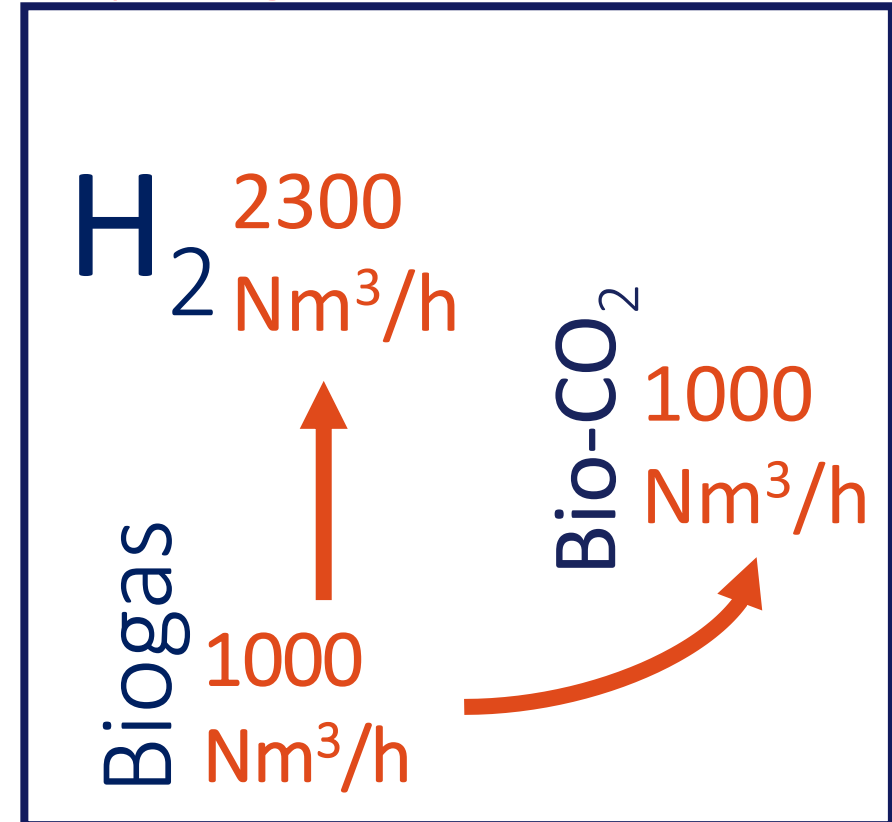

Green Hydrogen from Syngas and Biogas

Sorption Enhanced Water Gas Shift - SEWGS

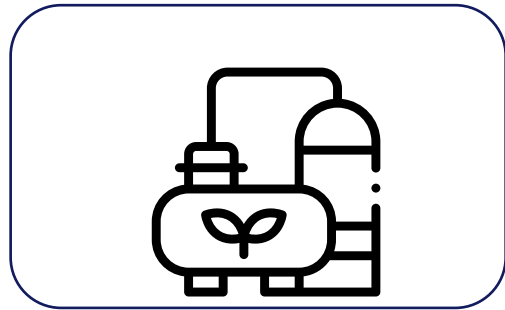

Biogas
 $\text{CH}_4 + \text{CO}_2$

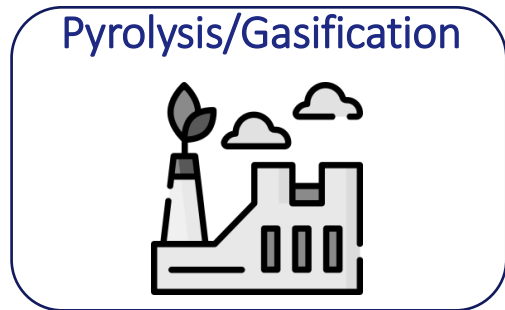

Syngas
 $\text{CO} + \text{H}_2$
 $\text{CH}_4 + \text{CO}_2$

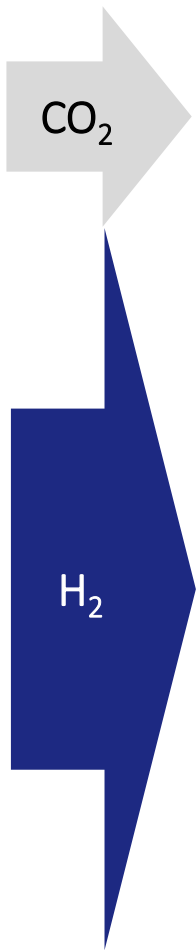
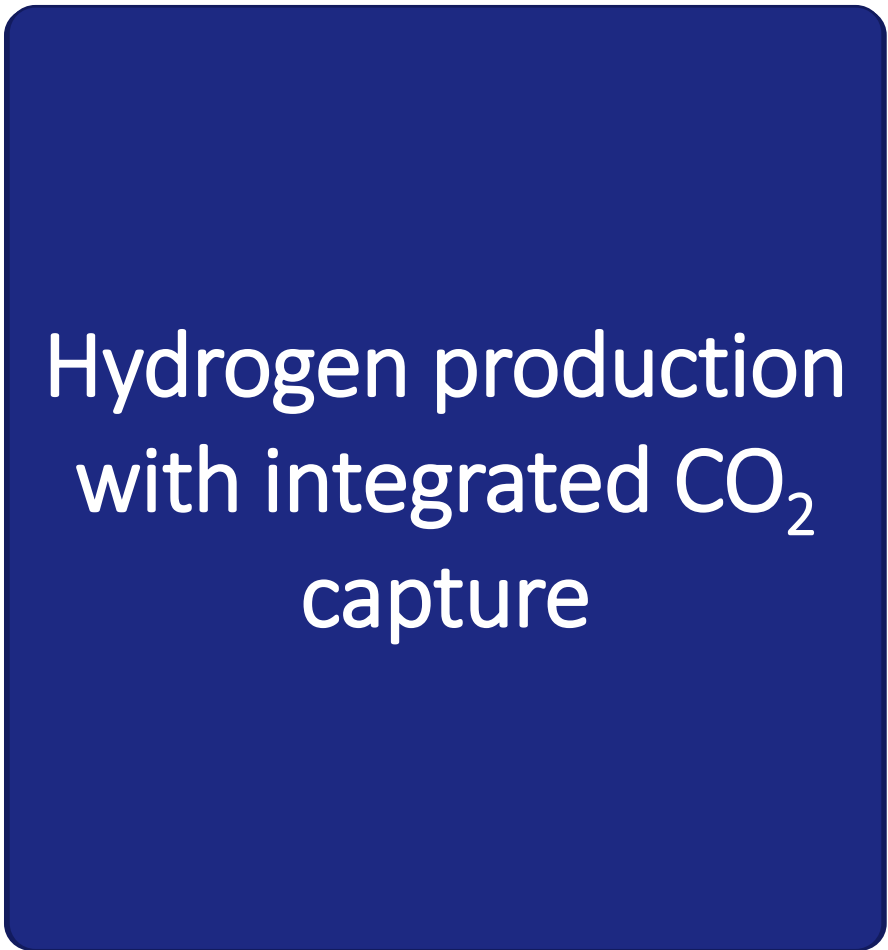

Transport

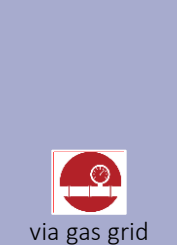
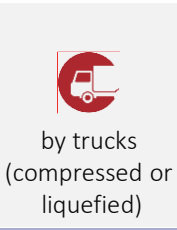

End-use

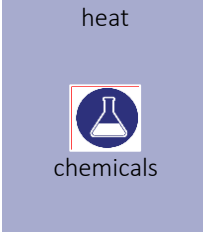
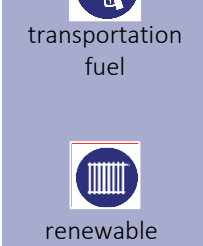
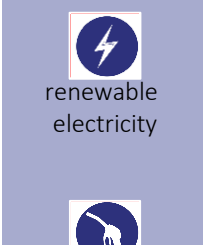
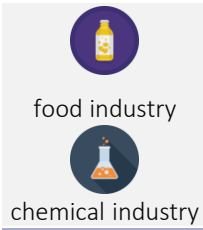

Concluding Remarks

The Sorption-Enhanced Reforming/Shift technology (SER/SEWGS) allows to combine the reforming, shift and CO₂ separation in two reactor vessels only providing the following advantages:

- A simpler and intensified process with fewer reactors, leading to a potentially more compact system
- Fewer costly consumables (no shift catalysts, no CO₂ solvent + additives)
- Improved heat integration possibilities due to CO₂ removal at high temperature
- Separated H₂ (>95 vol%) and CO₂ (> 95 vol%) streams that can be recombined for different fuel/chemical synthesis (methanol, DME) or valorised separately for other markets.
- The excess CO₂ can be sequestered (BECCS), used to substitute fossil CO₂ in industrial applications or as chemical, or combined with renewable H₂ to produce electro-fuels in power-to-X concepts for energy storage.
- The produced H₂ can also be used alone, as chemical or as fuel.
- Can reform liquid such as glycerol
- **These advantages result in CAPEX reduction of about 20-30% compared to conventional commercially available technologies.**



The CONVERGE project has received funding from the European Union's Horizon 2020 research and innovation programme under grant agreement N° 818135

Website: www.converge-h2020.eu

Researchgate: **CONVERGE: CarbON Valorisation in Energy-efficient Green fuels**

Linkedin: **showcase/converge-horizon2020**

Antonio Oliveira
Researcher
antonio.oliveira@ife.no