

Karen B. Lindberg • Marius Bagle • Igor Sartori
Pernille M.S. Seljom • Lisa Kvalbein • Eva Rosenberg
Mohammadreza Ahang • Asgeir Tomasgard
Stefan Jaehnert

Flexbuild Annual Report 1

TECHNICAL REPORT WITH RESULTS ANALYSIS

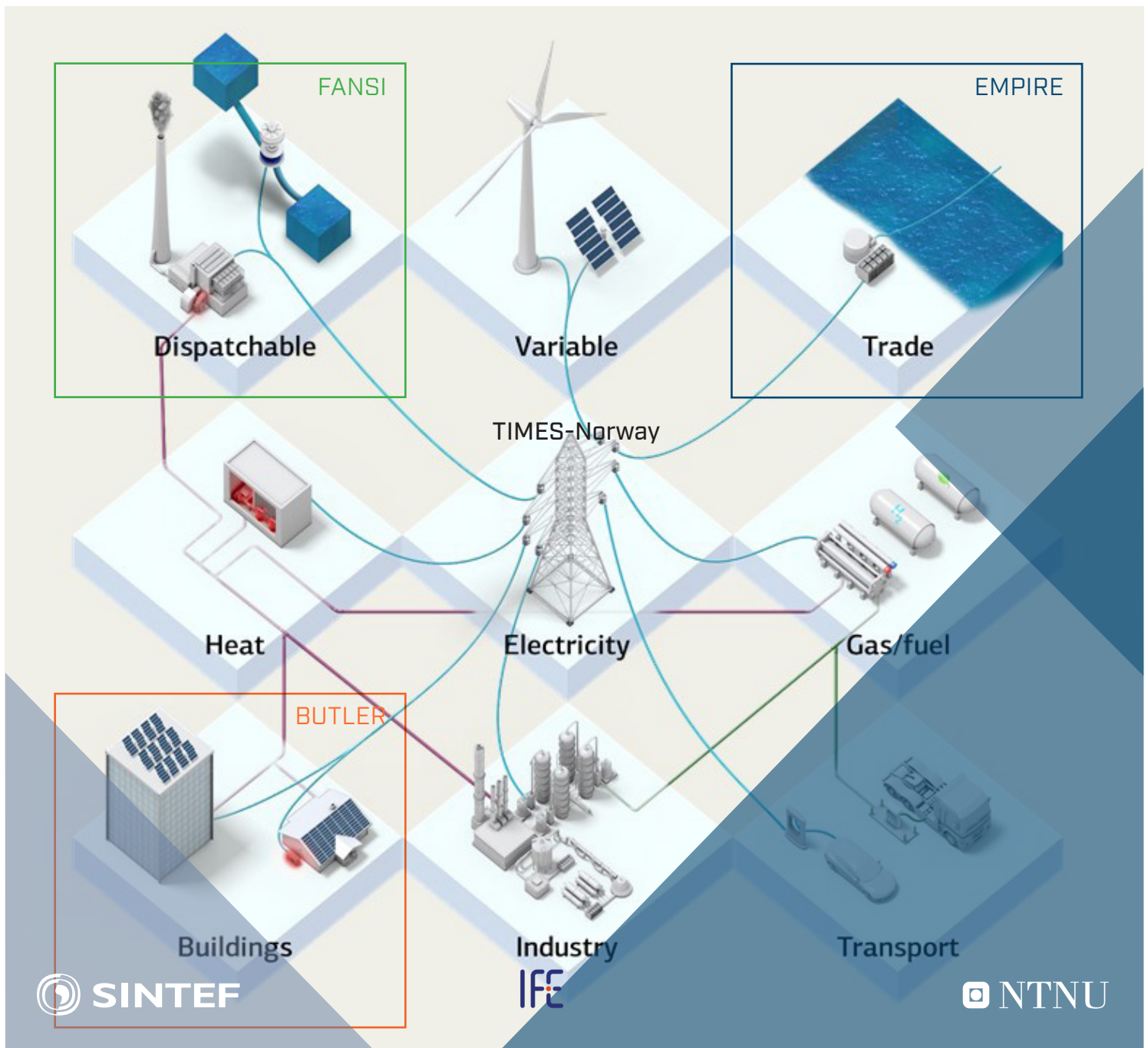

SINTEF Research

Karen B. Lindberg, Marius Bagle, Igor Sartori, Pernille M.S. Seljom, Lisa Kvalbein, Eva Rosenberg, Mohammadreza Ahang, Asgeir Tomasgard and Stefan Jaehnert

Flexbuild Annual Report 1

Technical report with results analysis

SINTEF Academic Press

SINTEF Research 69

Karen B. Lindberg¹⁾, Marius Bagle¹⁾, Igor Sartori¹⁾, Pernille M.S. Seljom²⁾,
Lisa Kvalbein²⁾, Eva Rosenberg²⁾, Mohammadreza Ahang³⁾,
Asgeir Tomasgard³⁾ and Stefan Jaehnert⁴⁾

Flexbuild Annual Report 1

Technical report with results analysis

¹⁾ SINTEF Community

²⁾ Institutt for Energiteknikk, IFE

³⁾ NTNU

⁴⁾ SINTEF Energy

Keywords: End-use flexibility, energy system modelling, buildings energy system, stochastic modelling

ISSN 1894-2466

ISBN 978-82-536-1675-9

Illustration, front cover: IEA, NETP 2016

© Copyright SINTEF akademisk forlag 2020

The material in this publication is covered by the provisions of the Norwegian Copyright Act. Without any special agreement with SINTEF Academic Press, any copying and making available of the material is only allowed to the extent that this is permitted by law or allowed through an agreement with Kopinor, the Reproduction Rights Organisation for Norway. Any use contrary to legislation or an agreement may lead to a liability for damages and confiscation, and may be punished by fines or imprisonment.

SINTEF Academic Press

P.O.Box 124 Blindern

N-0314 OSLO

Phone: +47 400 05 100

www.sintef.no/community

www.sintefbok.no

Preface

This report is a deliverable of the *Flexbuild* project, which is a knowledge-building project for industry (Kompetansebyggende prosjekt for næringslivet – KPN, in Norwegian) co-financed by the Research Council of Norway under the programme EnergiX, with grant agreement nr. 294920/E20 for the period 2019-2024. The industrial partners in the project are: Statsbygg, Omsorgsbygg (Oslobygg), Boligbyggelaget TOBB, Norsk Fjernvarme, Hafslund nett (Elvia) and Statnett; the public actors are: Norges vassdrags- og energidirektorat (NVE) and Enova; the research partners are: Institutt for Energiteknikk (IFE), Norges teknisk-naturvitenskapelige universitet (NTNU) and Danske Tekniske Universitet (DTU), together with SINTEF that is the project leader.

Project webpage: <https://www.sintef.no/projectweb/flexbuild/>

Oslo, 8.12.2020

Partow Pakdel Henriksen
Research Director
SINTEF Community

Igor Sartori
Project Leader
SINTEF Community

FlexBuild

"The value of end-use flexibility in the future Norwegian energy system."

The FlexBuild project will estimate the cost-optimal implementation of end-user flexibility from a socio-economic perspective. The results will quantify the effect of end-user flexibility on electricity consumption in individual buildings, but also on the aggregated national level. What is new in FlexBuild is that the value of end-user flexibility will be analyzed from a system perspective, with a solid stochastic modeling and detailed representation of the building sector. FlexBuild responds to knowledge gaps that have been identified by several actors, both from the supply side (power grid and district heating companies) to the end-user side (building owners) and public actors.

Sammendrag / Executive summary

Sammendrag

Prosjektpartnerne har blitt enige om behovet for å definere langsiktige storylines for eksterne variabler som påvirker modelleringsaktivitetene. Et storyline-verksted for alle industrielle partnere og forskningspartnere ble avholdt i januar 2020. De fire identifiserte "**storylines**" er beskrevet i kapittel 2 og har fått navnene:

- Energinasjonen Norge
- Petroleumsnasjonen Norge
- Naturnasjonen Norge
- Klimapanikk Norge

FlexBuild bruker et sett modeller for å gi innsikt i den fremtidige rollen og verdien av sluttbrukerfleksibilitet som er tilgjengelig i bygninger fra et norsk energisystemperspektiv. I FlexBuild bruker vi tre sektorspesifikke modeller for å gi detaljer om bestemte deler av energisystemet, mens energisystemmodellen brukes til å dekke koblingene mellom de forskjellige delene av energisystemet (se figur nedenfor). Modellene er:

- EMPIRE, for kraftsystemforbindelser utenfor Norge, med resten av Europa
- BUTLER, for byggesektoren i Norge
- TIMES-Norge, for energisystemet i Norge
- FanSi, for å zoome inn på vannkraftsektoren i Norge

Definering av kvantitative data som er i samsvar med de kvalitative storylines, ble utført for hver modell og er beskrevet i de neste kapitlene. Modellene har forskjellige grensesnitt. I TIMES er for eksempel datasett og grensevilkår definert for tre av fire storylines; i EMPIRE er de fire storylines gruppert i to, og identifiserer introduksjonen av CCS-teknologi i Europa. For BUTLER og FanSi er ennå ikke storyline-forskjellene implementert. Dette arbeidet vil fortsette og foredles i de påfølgende årene for å sikre en sammenhengende implementering av storylines i alle modeller. Se påfølgende figur.

Denne metoden gjør det mulig å utnytte styrken til hver modell, men utfordringen med å bruke en rekke modeller er at disse må harmoniseres og kobles sammen på en tilstrekkelig måte for å gi rimelig prosjektinnsikt. Metodikken for kobling av de forskjellige modellene er beskrevet i kapittel 3.

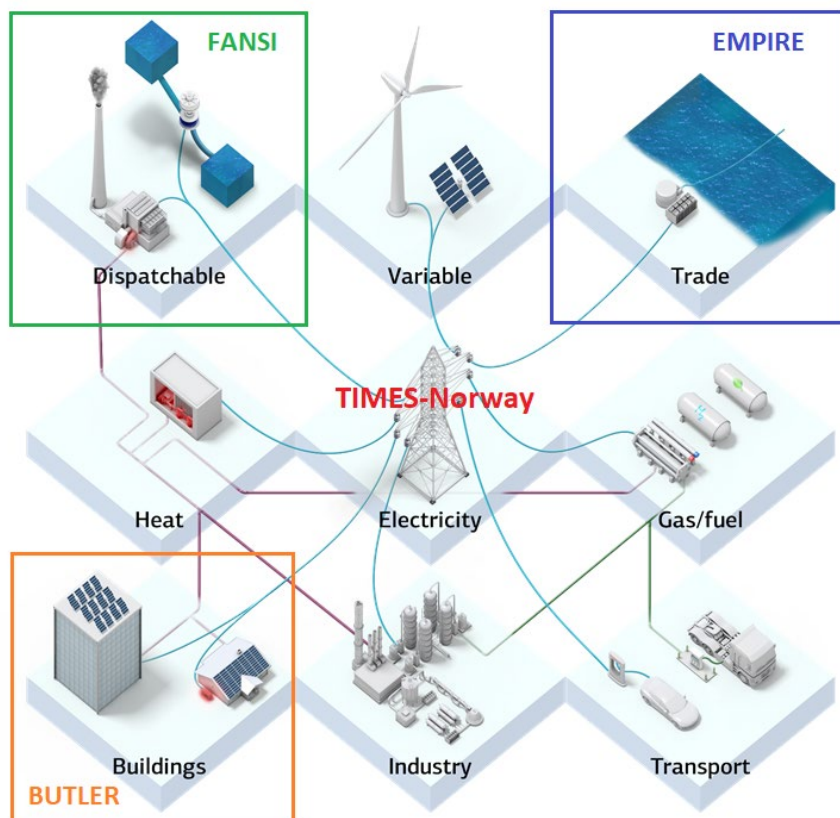

Illustrasjon av sektoriell dekning av de forskjellige FlexBuild-modellene.

Målet med **koblingsmetodikken** var å oppnå en toveis koblingsstrategi med klare og definerte konvergenskriterier mellom TIMES-Norge og de andre modellene. Koblingen mellom modellene er imidlertid i kontinuerlig utvikling, og det er foreløpig noen begrensninger knyttet til i hvor stor grad resultatene fra forskjellige modeller kan sammenlignes. Følgende ble oppnådd i koblingen mellom TIMES-Norge og sektormodellene:

- **EMPIRE:** Forventede strømpriser for land utenfor Norge er et resultat av EMPIRE, som brukes til innspill for TIMES-Norge.
- **BUTLER:** Harmonisering av teknologidata, etterspørselsprofiler (varme, varmt vann og elektrisitetsspesifikt) og solproduksjonsprofiler. De resulterende strømprisene og fjernvarmeprisene fra TIMES-Norge brukes som innspill til BUTLER.
- **FanSi:** Kobling til TIMES ble implementert i et tidligere prosjekt med en lignende kraftmarkedsmodell, som må forbedres ytterligere. Input vær-scenariene i FanSi krever et høyere detaljnivå enn de andre modellene. Eksisterende fremtidige analyser blir sammenlignet med TIMES-Norge for å identifisere riktige sett med innspill for å oversette storyline i FanSi.

Kapittel 4 til 7 beskriver i detalj utviklingen og hovedresultatene for hver modell i løpet av det første året av prosjektet. Et sammendrag av dette følger.

EMPIRE - Kraftsystem Europa:

Hovedresultatet av simuleringene er to scenarier, henholdsvis med og uten CCS-teknologi i Europa. De to scenariene fører til forskjellige energiproduksjonsblandinger, forskjellig utvidelse av overføringskapasitet for Norge og forskjellige priser. Spesielt viser scenarioet uten CCS betydelig høyere prisvariabilitet enn scenarioet med CCS.

BUTLER - Byggsektor Norge:

Hovedresultatet fra BUTLER er simuleringer av effekten forskjellige nettariffer har på enkeltbygg. De vurderte effekttariffene er de som er foreslått av NVE i høring fra 2019: *Daglig topp last, effektabonnement, Sikring differensiert*, pluss gjeldende tollsatser for energipriser (små kunder) og månedlig topplast (store kunder). Selv om de forskjellige oppvarmingsteknologiene påvirkes noe annerledes av nettariff valgene ser det ut til at den daglige topplast-tariffordningen er den mest lovende når det gjelder å redusere topplasten på de kaldeste dagene. Reduksjonen gjelder både vanlige og energieffektive bygninger (med hensyn til bygningskroppen), selv om forskjellen i topplast er betydelig lavere i den energieffektive bygningskategorien.

Figuren under viser at effektabonnement (lyse farger) holder belastningen under abonnementsgrensen (her: 8 kW for REF, 6 kW for rglASHP og 4 kW for effASHP) så lenge som mulig, men med en gang det er nødvendig å gå over denne grensen, ser det ut til å være likegyldig hvor mye grensen er brutt. Derfor reduseres topplasten bare med 1 %, 1 % og 8 % i forhold til toppbelastningen med gjeldende energipriser (solid mørk linje) for hver av de tre bygningskategoriene, henholdsvis REF, rglASHP og effASHP.

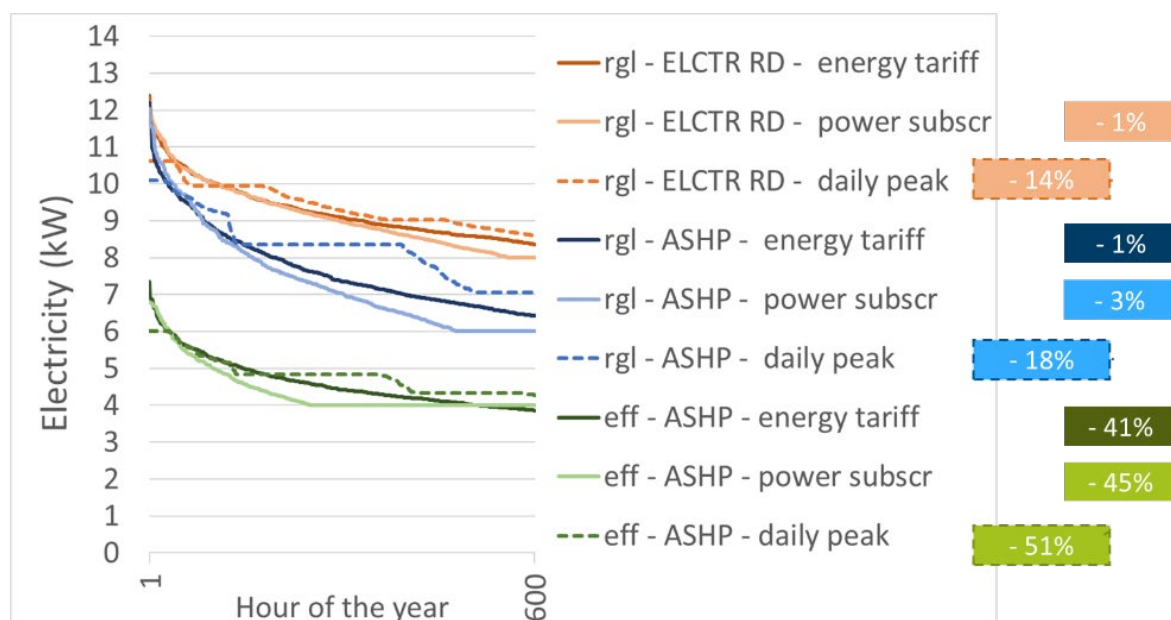

Varighetskurve for netto elektrisk lastprofil med de alternative krafttariffene: gjeldende energipriser (solid mørk linje), strømabonnement (heldekkende lys linje) og daglig målt topp (stiplet linje). Boksene til høyre viser reduksjon av maksimal toppbelastning i forhold til referansen.

Resultatene for den daglige målte topp-tariffen vises med stiplede linjer. Med den daglige målte topp-tariffen er det et sterkere insentiv for å holde topplasten så lav som mulig på alle timer, og topplasten reduseres med henholdsvis 14 %, 17 % og 18 % for REF, rglASHP og effASHP sammenlignet med toppbelastning med gjeldende energipriser for hvert tilfelle.

Hvorfor oppstår disse topplastreduksjonene? Svaret ligger i fleksibiliteten i varmelageret som det vannbårne varmedistribusjonssystemet og varmtvannsberedere tilbyr.

TIMES-Norge - Energisystem Norge

Tre av de fire storylines har blitt kvantifisert som forskjellige inndatasett, og har blitt analysert av den norske energisystemmodellen, TIMES-Norge. Resultatene viser kostnadsoptimale investerings- og driftsvedtak fra det norske energisystemet fra 2020 til 2050 for de fem norske spotprisregionene. Resultatene viser også at investeringer i fornybar energi, strømforbruk fordelt etter sektor, elektrisitetshandel til Europa og strømpriser varierer betydelig mellom storylines. Mer spesifikt for byggesektoren viser resultatene at den kostnadsoptimale bygningsintegreerte PV-produksjonen bidrar til mellom 6 og 8 prosent av den norske strømforsyningen i 2050. Energibruken og topp-elektrisitet avhenger sterkt av den fremtidige utviklingen av energisystemet: Energieffektiviseringstiltakene og et mer sentralisert bosettingsmønster har betydelig innvirkning på topp-elektrisitet og det totale energibehov i bygninger. Et annet funn er at fleksibel EV-lading påvirker integreringen av fornybar energi, og at en fleksibel drift av varmtvannstanker vil senke etterspørselen etter elektrisitet, men i begrenset grad.

Figuren nedenfor viser tilbud og etterspørsel for næringsbygg i 2050 (i kraftkapasitet) for to storylines i NO1.

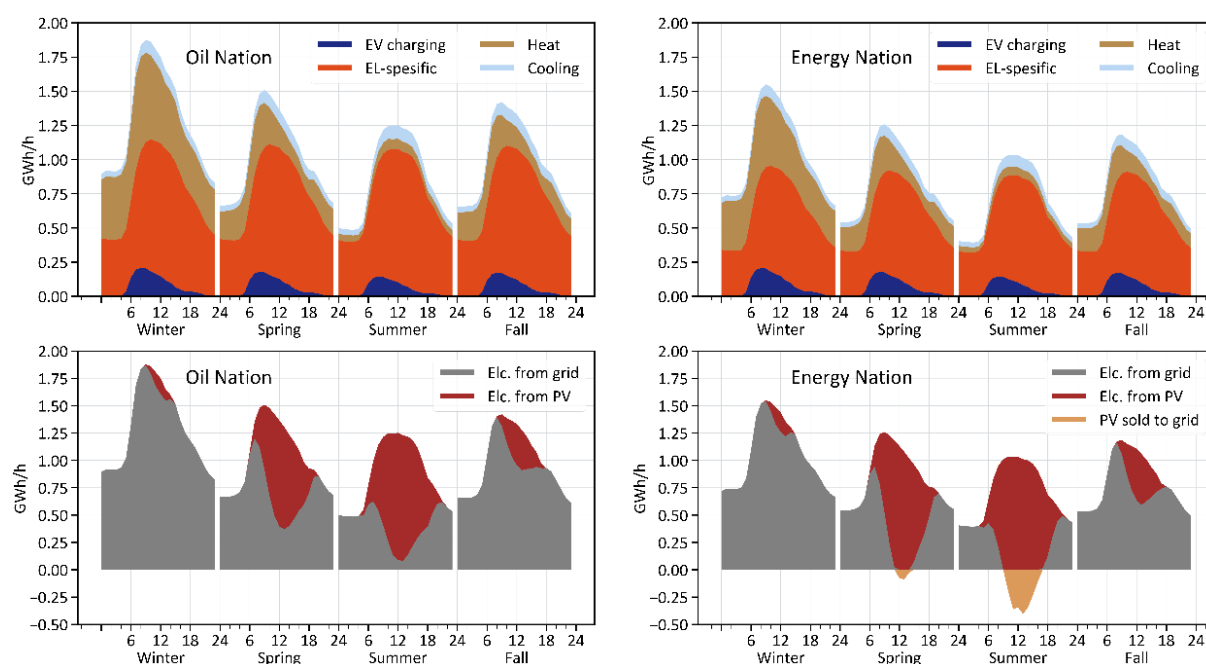

Etterspørsel (øverst) og tilbud (nederst) for næringsbygg i to storylines: Oljenasjon (til venstre) og Energinasjon (til høyre) for spotregionen NO1 i 2050.

Totalt er etterspørselen fra nettet redusert med 3,2 TWh i Oljenasjonen, 5,3 TWh i Energinasjonen og 4,7 TWh i Naturnasjonen på grunn av PV (Photovoltaics) på næringsbygg. Som det også vises i tabell 13, er etterspørsel gjennom året bare redusert marginalt for NO1 og NO2 i alle storylines ettersom etterspørselen skjer i perioder (timer) med lav PV. Endringen i etterspørsel mellom storylines skyldes energieffektiviseringstiltak.

FanSi - Kraftsystem Norge

Hensikten med FanSi – som ikke vil bli videreutviklet i dette prosjektet – er å vurdere effekten av det norske vannkraftsystemet (lønnsomheten av fleksibilitet) ved å koble til resultatene fra TIMES-Norge. Siden koblingen fremdeles er under utvikling, er et sett med tidligere utviklede lavutslippsscenarioer modellert i FanSi blitt sammenlignet med storyline-resultatene fra TIMES-Norge. Hovedvirkningen av forskjellige scenarioer er på kraftprisvariabiliteten (f.eks. antall timer med høy pris) snarere enn prisnivået. Vannkraft har muligheten til å utnytte prisvariabilitet for å oppnå høyere priser enn gjennomsnittet, ved å levere fleksibilitet.

Siden koblingen mellom modellene er i kontinuerlig utvikling, kan ikke modellene sammenlignes direkte. Den viktigste koblingen er mellom BUTLER og TIMES-Norge, fordi sluttbruksfleksibiliteten

(fra byggesektoren) som påvirker energisystemet, er det sentrale fokuset i dette prosjektet. Samtidig er innflytelse fra det europeiske kraftmarkedet og innvirkningen på det norske vannkraftsystemet grensebetingelser, og fordi resultatene fra disse to modellene for det meste er avhengige av hverandre. En sammenligning av resultatene fra disse to modellene (det samlede nivået av markedsområdet NO1 (Sør-Øst-regionen)) viser at det er betydelig samsvar mellom de to modellene. Dette er positivt fordi det viser at når de to modellene er matet med harmonisert inngang, oppnår man harmoniserte utganger til tross for de indre tekniske forskjellene. På den annen side ser det lovende ut å sikte mot konvergens av de to modellene (med et begrenset antall iterasjoner) med en toveis kobling når resultatene allerede er vesentlig like, selv når det er en enkel ensrettet kobling.

Følgende punkter viser et sammendrag av det **fremtidige arbeidet** som forskningspartnerne har foreslått:

- Storylines: Fortsett med definisjonen av datasett og forutsetninger som kvantifiserer storyline-beskrivelsen på en konsistent og harmonisert måte på tvers av modellene.
- Koblingsmetodikk: Neste trinn i koblingen mellom TIMES-Norge og sektormodellene er å utvikle en toveis koblingsstrategi med et klart definert konvergenzkriterium.
- EMPIRE-utvikling: Dette vil bli definert i PhD-planen med kandidaten.
- BUTLER-utvikling:
 - Fortsette med forbedringer av oppvarmingsteknologier, spesielt varmpumper
 - Forbedre modelleringen av lagringsteknologier: varmtvannstank, batteri og EV
 - Implementering av dynamikken i bygningens termiske masse
- TIMES-utvikling:
 - Inkludere en stokastisk modellering av kortsiktig usikkerhet knyttet til PV-produksjon, vindkraft og varmebehov
 - Inkludere modellering av sluttbruk (lagring) fleksibilitetstiltak: varmtvannstank og EV fleksibel lading, lagring i fjernvarme og komfort fleksibilitet (termisk lagring i bygninger)
- FanSi-utvikling:
 - Definere datasett og andre grenseforhold som er sammenhengende/kompatible med storylines, med det nødvendige detaljnivået for å redegjøre for kortsiktige usikkerhetsmomenter for tilstrømning, temperatur og vind- og solkraftproduksjon
 - Vurdere kraftprisstrukturen og lønnsomheten til vannkraft og mulige andre fleksibilitetsalternativer i kraftsystemet for de utviklede storylines

Med bakgrunn i tilbakemeldinger fra industripartnere vil den endelige planen for arbeidet de neste årene av prosjektet bli definert.

Executive summary

The project partners have agreed on the need to define long-term storylines for external variables influencing the modeling activities. A Storyline workshop for all industrial and research partners was held in January 2020. The four identified **Storylines** are described in Chapter 2 and are named:

- Energy nation Norway
- Petroleum nation Norway
- Nature nation Norway
- Climate panic nation

The definition of quantitative data that is consistent with the qualitative long-term storylines is a task that has been performed for each model and is described in the following chapters. The extent to which this has been feasible during the first year of the project varies between the models. For example, in TIMES datasets and boundary conditions have been defined for three out of four storylines; in EMPIRE the four storylines have been grouped into two, identifying the introduction of CCS technology in Europe as the biggest discriminant, while BUTLER and FanSi have not yet implemented storylines differentiations. This work will continue and be refined in the following years to ensure a coherent implementation of the storylines in all models.

FlexBuild uses a set of models to provide insights on the future role and value of end-use flexibility available in buildings from a Norwegian energy system perspective. In FlexBuild, we use three sector-specific models to provide details of specific parts of the energy system, whereas the energy system model is used to cover the connections between the different parts of the energy system (see Figure below). The models are:

- EMPIRE, for the power system interconnections outside Norway, with the rest of Europe;
- BUTLER, for the building sector in Norway;
- TIMES-Norway, for the energy system in Norway
- FanSi, for a zoom-in on the hydropower sector in Norway.

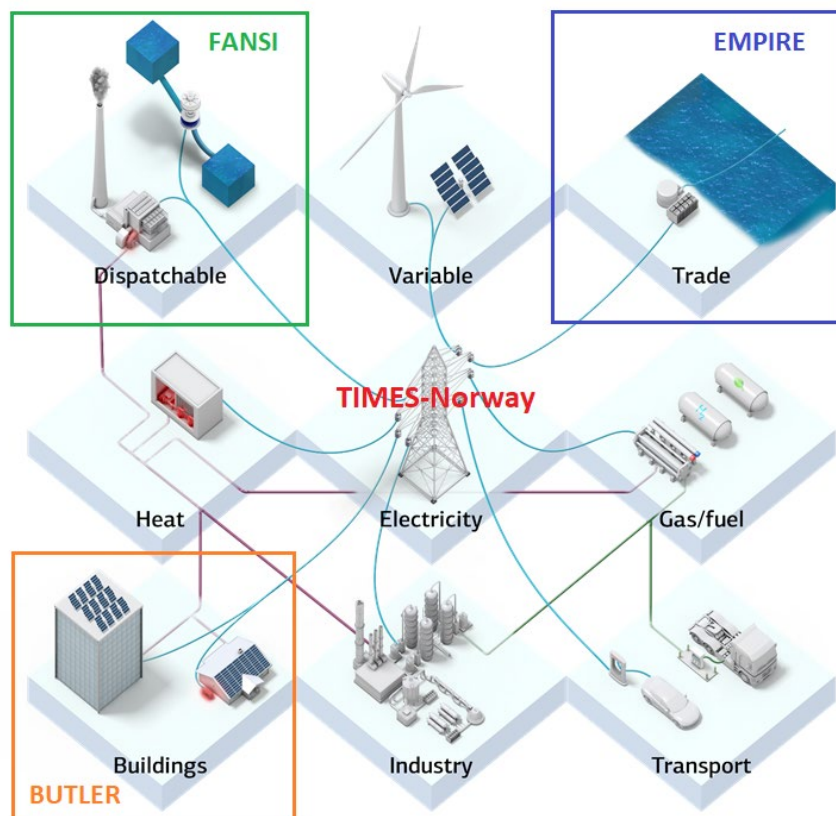

Illustration of sectoral coverage of the various FlexBuild models.

This approach allows us to exploit the strength of each model, but the challenge of using numerous models is that these models need to be harmonized and linked in an adequate manner to provide reasonable project insight. The methodology for linking the different models is described in Chapter 3.

The aim of the **linking methodology** is to achieve a bi-directional linking strategy with clearly defined convergence criteria, between TIMES-Norway and the other sectorial models. However, the linking between the models is an ongoing development, and so the extent to which results from different models can be compared is somewhat limited for the time being. In particular, this has been achieved by now in the linking between TIMES-Norway and the sectorial models:

- EMPIRE: the expected electricity prices for countries outside Norway are a result of EMPIRE that is used in input to TIMES-Norway;
- BUTLER: harmonization of the technical data, demand profiles (heat, hot water, and electricity specific) and solar generation profiles. The resulting electricity prices and district heat prices from TIMES-Norway is used as an input to BUTLER;
- FanSi: Linking to TIMES was implemented in an earlier project with a similar power market model, which needs to be further improved. The input weather scenarios in FanSi require a higher level of detail than the other models. Existing future analyses are compared with TIMES-Norway to identify proper sets of input for translating the storyline in FanSi.

Chapters 4 to 7 describe in detail the developments and main results for each model during this first year of the project, for which a summary is given here.

EMPIRE – Power system Europe:

The main result is the simulation of two scenarios, respectively, with and without CCS technology in Europe. The two scenarios lead to different energy production mixes, different transmission capacity expansion for Norway, and different prices. In particular, the scenario without CCS shows significantly higher price variability than the scenario with CCS.

BUTLER – Building sector Norway:

The main result is the simulation of the effect of different grid tariffs on single buildings. The tariff schemes considered are those proposed by NVE in its proposal's hearing of 2019, *Daily peak power*, *Power subscription*, *Fuse differentiated*, plus the current tariffs *energy pricing (small customers)* and *Monthly peak power (large customers)*. Although different heating technologies are affected somewhat differently by the grid tariff, the daily peak power tariff scheme appears to be most promising to reduce peak power during the coldest days. The reduction applies to both regular and efficient buildings (in terms of goodness of the building envelope), although the difference in peak power is significantly lower in the efficient type, to begin with.

Most of the work has been concentrated on enhancing the models for space heating technology, and to introduce an EV model. An effort has also been put in harmonizing technology data and weather data with TIMES-Norway, and to aggregate the result for a geographical area.

The Figure below shows that the subscription tariff (light colors) keeps the load below the subscribed limit (here: 8 kW for *REF*, 6 kW for *rglASHP*, and 4 kW for *effASHP*), as long as possible, but once it is necessary to go above this limit, the model seems to be indifferent to how much the limit is violated. Hence, the peak load is only reduced by 1%, 1%, and 8% relative to the peak load with current energy pricing (solid dark line) for each of the three-building cases *REF*, *rglASHP* and *effASHP*, respectively.

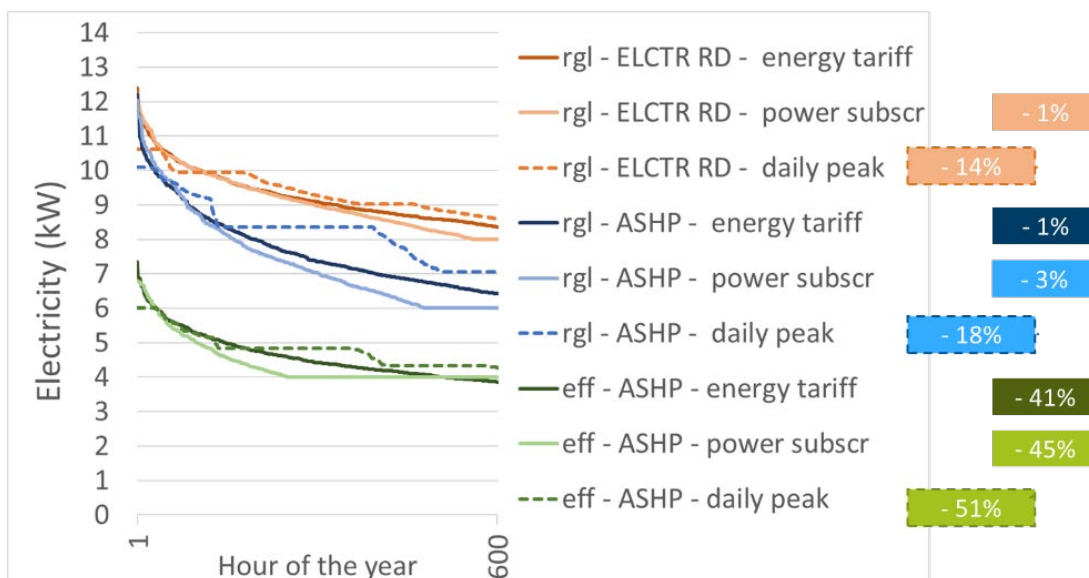

Duration curve of the *net electric load* profile with the alternative power tariffs: current energy pricing (solid dark line), power subscription (solid light line), and daily measured peak (dashed line). The boxes to the right show the reduction of the maximum peak load relative to the reference case.

Results for the daily measured peak tariff are shown with dashed lines. With the daily measured peak tariff, there is a stronger incentive to keep the peak load as low as possible in all hours, and the peak load is reduced by respectively 14%, 17% and 18% for *REF*, *rglASHP*, and *effASHP* compared to the peak load with current energy pricing for each of the cases. Why do these peak load reductions occur? The answer lies in the flexibility of the heat storage that the waterborne heat distribution system offers, in addition to the domestic hot water tank.

TIMES-Norway – Energy system Norway

Three out of the four storylines have been quantified as different input datasets and analyzed by the Norwegian energy system model, TIMES-Norway. The corresponding results provide cost-optimal investment and operational decisions of the Norwegian energy system from 2020 to 2050 for the five Norwegian spot price regions. The results show that investments in renewables, electricity consumption by sector, electricity trade to Europe and electricity prices varies significantly between the storylines. More specific for the building sector, the results demonstrate the cost-optimal building-integrated PV generation contributes to between 6% and 8% of the Norwegian electricity supply in 2050, the energy use and the peak electricity demand highly depends on the future evolvement of the energy system; the energy efficiency measures and a more centralized settlement pattern has a significant impact on peak electricity and total energy demand in buildings. Another finding is that flexible EV charging influences the integration of renewables and that a flexible operation of hot water tanks will lower the peak electricity demand, but to a limited extent.

The figure below demonstrates the supply and demand of commercial buildings in 2050 (in power capacity) for two storylines for NO1.

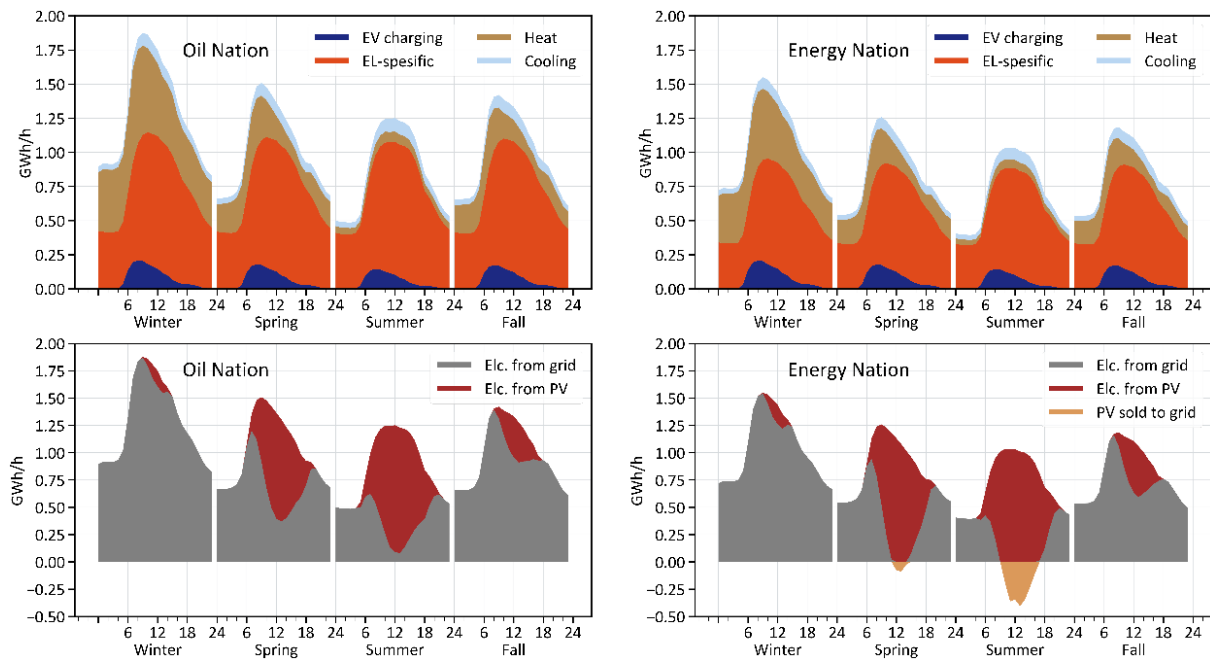

Demand (top) and supply (bottom) for commercial buildings in the two storylines Oil Nation (left) and Energy Nation (right) for the spot region NO1 in 2050.

In total, the demand from the grid is lowered by 3.2 TWh in the *Oil nation*, 5.3 TWh in *Energy nation* and 4.7 TWh in *Nature nation* due to PV on commercial buildings.

FanSi - Power system Norway

The purpose with FanSi – which will not be further developed in this project – is to assess the effect of the Norwegian hydropower system for the profitability of flexibility, by linking with the results from TIMES-Norway. Since the linking is still under development, a set of previously developed low-emission scenarios modeled in FanSi have been compared with the Storyline results from TIMES-Norway. A major outcome is that the main impact of different scenarios is on power price variability (e.g. number of hours with high price) rather than price levels. Hydropower has the ability to exploit price variability in order to achieve higher prices than average by delivering flexibility.

Since the linking between the models is an ongoing development, the extent to which results from different models can be compared is somewhat limited for the time being. The most essential linking is between BUTLER and TIMES-Norway, both because the end-use flexibility (from the building sector) impact on the energy system is the central focus of this project – while influence from the European power market and impact on the Norwegian hydropower system are boundary conditions – and because the results of these two models are mostly interdependent. A **comparison of the results** from the two models on the aggregated level of market area NO1 (South-East region) shows that there is substantial agreement between the two models. This is encouraging because it shows that once the two models are fed with harmonized input, one obtains harmonized outputs despite the inner technical differences. On the other hand, it looks promising to aim at the convergence of two models (with a limited number of iterations) with a bi-directional linking when the results are already substantially similar, even when there is a simple uni-directional link.

The following points are the summary of the **future work** proposed by the research partners:

- *Storylines*: continue with the definition of datasets and assumptions that quantify the storyline description in a consistent and harmonized way across the models;
- *Linking methodology*: the next step of the linking between TIMES-Norway and the sectorial models is to develop a bi-directional linking strategy with a clearly defined convergence criterion;
- *EMPIRE developments*: this will be defined within the Ph.D. plan with the candidate;

- *BUTLER developments:*
 - continue with heating technologies improvements, especially heat pumps.
 - Improve the modeling of storage technologies: hot water tank, battery and EV.
 - Implementation of the thermal mass dynamics of buildings;
- *TIMES developments:*
 - include stochastic modeling of short-term uncertainty related to PV generation, wind power, and heat demand.
 - Include modeling of end-use (storage) flexibility measures: hot water tank and EV flexible charging, storage in district heating, and (comfort) flexibility: thermal storage in buildings.
- *FanSi developments:*
 - define datasets and other boundary conditions that are coherent/compatible with the Storylines, with the necessary level of detail to account for the short-term uncertainties for inflow, temperature, wind- and solar power generation.
 - Assess the power price structure and profitability of hydropower and potential other flexibility options within the power system for the developed storylines.

Finally, the final priorities for future work in the next year(s) of the project will be defined considering the feedback from the industrial partners, included in their Annual Memo.

Contents

PREFACE	3
FLEXBUILD.....	5
SAMMENDRAG / EXECUTIVE SUMMARY	5
SAMMENDRAG	5
EXECUTIVE SUMMARY	10
1 STORYLINES	17
1.1 ENERGINASJONEN NORGE / ENERGY NATION NORWAY	17
1.2 PETROLEUMSNASJONEN NORGE / PETROLEUM NATION NORWAY	18
1.3 NATURNASJONEN NORGE / NATURE NATION NORWAY	19
1.4 KLIMAPANIKKNASJON / CLIMATE PANIC NATION	19
2 INTRODUCTION – THE LINK BETWEEN THE MODELS.....	21
3 POWER SYSTEM EUROPE – EMPIRE	24
3.1 SHORT DESCRIPTION OF THE EMPIRE MODEL.....	24
3.2 GENERATION CAPACITIES, ENERGY MIX, AND TRANSMISSION EXPANSION	25
3.3 CORRESPONDING “ELECTRICITY PRICES”.....	26
3.4 REFERENCES.....	28
4 BUILDING SECTOR NORWAY – BUTLER.....	30
4.1 INTRODUCTION: BRIEF MODEL DESCRIPTION.....	30
4.2 MODEL STRUCTURE.....	31
4.2.1 <i>Building categories</i>	31
4.2.2 <i>Regular and efficient buildings</i>	32
4.2.3 <i>Building's heat distribution system</i>	33
4.2.4 <i>Total BUTLER modes</i>	34
4.3 TECHNOLOGY ENHANCEMENTS.....	35
4.3.1 <i>Heat pumps</i>	35
4.3.2 <i>Battery (without binaries)</i>	36
4.3.3 <i>Grid tariffs</i>	37
4.3.4 <i>EV-demand (driving demand per week)</i>	38
4.3.5 <i>Renovation (insulation & VBV)</i>	39
4.3.6 <i>Stochasticity/stochastic database</i>	39
4.4 INPUT AND OUTPUT DATA	40
4.5 AGGREGATION	43
4.6 RESULTS /INPUT TO TIMES.....	44
4.6.1 <i>Impact of new power tariffs on a single residential building</i>	44
4.6.2 <i>Aggregated results for NOI</i>	47
4.7 FURTHER WORK.....	50
4.8 REFERENCES.....	50
5 ENERGY SYSTEM NORWAY – TIMES-NORWAY	53
5.1 TIMES-NORWAY MODEL DESCRIPTION	53
5.1.1 <i>Building sector</i>	54
5.2 STORYLINE ASSUMPTIONS FOR TIMES-NORWAY	55
5.2.1 <i>Technology learning: Green hydrogen</i>	56
5.2.2 <i>Technology learning: Solar power and stationary batteries</i>	57
5.2.3 <i>Cost for building-integrated solar power</i>	57
5.2.4 <i>Wind power potential</i>	57
5.2.5 <i>Technology learning: Wind power</i>	58
5.2.6 <i>Transmission grid expansion</i>	58
5.2.7 <i>Settlement patterns and energy efficiency in buildings</i>	59
5.2.8 <i>Transport demand projection</i>	60
5.2.9 <i>Industry demand projections</i>	61
5.2.10 <i>European electricity prices</i>	62

5.3	MODEL RESULTS.....	63
5.3.1	<i>Electricity balance</i>	63
5.3.2	<i>Transmission Capacity</i>	65
5.3.3	<i>Electricity Prices</i>	66
5.3.4	<i>Residential heating technologies</i>	67
5.3.5	<i>Commercial heating technologies</i>	69
5.3.6	<i>Buildings electricity balance</i>	69
5.3.7	<i>Sensitivity: Impact of the EV charging profile</i>	71
5.3.8	<i>Sensitivity: Impact of charging profile of hot water tank</i>	73
5.3.9	<i>Sensitivity: Impact of electricity grid tariffs for solar power</i>	74
5.4	SUGGESTIONS FOR FURTHER WORK.....	75
5.5	APPENDIX A – TECHNICAL ASSUMPTIONS OF THE BUILDING SECTOR.....	76
6	HYDROPOWER MARKET SIMULATION TOOLS – FANSI.....	78
6.1	POWER MARKET SIMULATION MODELS FOR HYDROPOWER SYSTEMS.....	78
6.1.1	<i>FanSi</i>	79
6.2	REPRESENTING STORYLINES IN THE NORDIC POWER MARKET MODELS.....	80
6.3	FURTHER WORK.....	84
6.4	REFERENCES.....	84
7	COMPARISON OF MODELS' RESULTS AND CONCLUSIONS.....	86
7.1	COMPARISON OF MODELS' RESULTS.....	86
7.2	FUTURE WORK.....	89

1 Storylines

Asgeir Tomasgard (NTNU)

The project partners have agreed on the need to define long-term storylines for external variables influencing the modeling activities, such as the future developments of the building stock (new constructions, demolitions, energy-efficient renovations), technology development, EU directives, building norms, economic growth, consumer preferences, and political instability.

A Storylines workshop for all industrial and research partners was held in January 2020. The workshop has given a common understanding of key external uncertainties related to the future integration of the building sector to the energy system. Based on an explorative scenario approach, the workshop ended up with a selected number of long-term storylines, representing possible futures, that will set the basis for further project work. The four identified Storylines are presented below both in English and in Norwegian.

The definition of quantitative data that is consistent with the qualitative long-term storylines is a task needed to ensure consistent input to the various models and to further clarify the model assumptions. The data can, for example, include data on technical learning curves, energy prices, and quantifiable policy targets. This task has been performed for each model and is described in the following chapters. The extent to which this has been feasible during the first year of the project varies between the models. For example, in TIMES datasets and boundary conditions have been defined for three out of four storylines; in EMPIRE the four storylines have been grouped into two, identifying the introduction of CCS technology in Europe as the biggest discriminant; while BUTLER and FanSi have not yet implemented storylines differentiations. This work will continue and be refined in the following years to ensure a coherent implementation of the storylines in all models.

1.1 Energinasjonen Norge / Energy nation Norway

English

There is wide political will in both Norway and Europe to tackle the climate crisis. Both regulations and market mechanisms such as the EU ETS (Emission Trading System) stand strong. The society is increasingly electrified since CCS technology never becomes commercial. This also means that by 2050 the Norwegian oil and gas will be completely out of the market, and the petroleum sector will be phased off the Norwegian economy.

Norway supports in large scale the deployment of renewable energy, mainly offshore and onshore wind, but also building-integrated PV. Solar cells become common roofing in new buildings and roof renovations. Energy efficiency is not supported with subsidies but is implemented where profitable. It is focused on freeing generation capacity that can be exported.

In addition to exports, the increased energy volumes make Norway an attractive country for energy-intensive industries. Norway becomes a major exporter of energy products (goods with high energy content). The increase in electricity demand comes mainly from the industry.

Without fossil fuels, the transport sector is based on battery electric vehicles, hydrogen and supplemented by biofuels. Power-to-X technologies receive increased attention and provide increased flexibility in the power sector. Other sources of flexibility are active consumers and flexible buildings and neighborhoods.

The energy system has increased decentralized energy production, but transmission lines are used to provide the system with the flexibility, including export cables.

Norwegian

Det er stor politisk vilje både i Norge og Europa til å håndtere klimakrisen. Både regulering og markeds mekanismer som EU ETS står sterkt. Samfunnet elektrifiseres, siden CCS teknologien aldri blir kommersiell. Det betyr og at i 2050 er norsk olje og gass helt borte fra markedene og petroleumssektoren er faset ut av norsk økonomi.

Norge satser på storstilt utbygging av fornybar energi, hovedsakelig offshore og onshore vind, men og solceller integrert i bygg. Solceller blir den vanlige taktekkingen på nye bygg og for rehabilitering av tak. Energieffektivisering støttes ikke med subsidier, men gjennomføres dersom det er lønnsomt. Da fokuseres det på å frigjøre energi og effekt som kan eksporteres.

I tillegg til eksport gjør de økte energivolumene Norge til et attraktivt land for energiforedlende industri. Norge blir en stor eksportør av energivarer (varer med et stort energiinnhold). Økningen i el-etterspørsel kommer hovedsakelig fra industri.

Uten fossile drivstoff er transportbransjen basert på batterielektrisk, hydrogen og supplement fra biodrivstoff. Power-to-X teknologier får økt fokus og gir økt fleksibilitet i kraftsektoren. Andre fleksibilitetskilder er aktive konsumenter og fleksible bygg/nabolag.

Systemet har økt desentralisert energiproduksjon, men transmisjon benyttes til å forsyne systemet med fleksibilitet, inklusive utenlandskabler.

1.2 Petroleumsnasjonen Norge / Petroleum nation Norway

English

There is wide political will in both Norway and Europe to tackle the climate crisis. Both regulations and market mechanisms such as the EU ETS (Emission Trading System) stand strong. CCS technology becomes commercial during the next decade. This means that by 2050 there is still demand Norwegian oil and gas, and we have found large quantities of new gas. CO₂ is a commercial product, and CCU (Carbon Capture and Utilization) stands strong. Hydrogen is considered one of the major sources of flexibility. The focus is on centralized large-scale solutions for energy production. Renewable energy grows sharply, although, in Norway, it is mainly wind power and mostly offshore.

The transport sector uses mainly hydrogen and battery electric vehicles. Household consumption is approximately at today's level or slightly increased. Energy efficiency has economic motivation. The Norwegian power export is moderate, and there is less need for wind power. This is market-driven, and there is a political acceptance that for several years there is power deficit and net import. In addition to industry CCS, we see increasing electrification of industry.

Norwegian

Det er stor politisk vilje både i Norge og Europa til å håndtere klimakrisen. Både regulering og markeds mekanismer som EU ETS står sterkt. CCS teknologien blir kommersiell i løpet av det neste tiåret. Det betyr at i 2050 er norsk olje og gass fortatt etterspurt og vi har funnet store mengder ny gass. CO₂ er et handelsprodukt og CCU står sterkt. Hydrogen regnes som en av de store fleksibilitetskildene. Fokuset er på sentraliserte storskalaløsninger for energiproduksjon. Fornybar energiproduksjon øker kraftig, men i Norge hovedsakelig vindkraft og mest til havs.

Transportsektoren benyttet hovedsakelig hydrogen og batterielektrisk. Forbruket i husholdninger er omtrent som i dag eller økende. Energieffektivisering er økonomisk motivert. Norsk krafteksport er moderat, og det er mindre behov for vindkraft. Dette drives av markedet, og det er politisk aksept for at det i mange år er kraftunderskudd og netto import. I tillegg til industri CCS ser vi en økende elektrifisering av industri.

1.3 Naturnasjonen Norge / Nature nation Norway

English

The national identity is in focus, and the protection of nature gets increased support. Intervention on nature is minimized. This creates an increased focus on energy efficiency, renovation, circular economy, and other resources utilization, such as waste heat.

In the energy sector, the focus is on reducing demand, and there is acceptance for lower economic growth. Development and new industrial activity are mainly created in other sectors than renewable energy production. Densification and urbanization lead to more efficient systems for transport and energy supply.

CCS is commercialized before 2030, and centralized solutions in the local environment or cities play a large role in energy security and energy supply. Hydrogen production with CCS and power generation from natural gas with CCS play a role in the European power system, and the Norwegian economy depends on this. Waste incineration and heat production with CCS play an important role in the transformation of large cities.

At the same time, there is less acceptance for transmission lines and large intervention on nature, except for export cables and offshore wind.

Personal CO₂ quota is being discussed. Politicians propose establishing markets for it, preferably at a European level. An EU Emission Trading System – Personal is established for all European countries.

Norwegian

Nasjonal identitet er i fokus og vern av natur får økt oppslutning. Naturinngrep minimeres. Det skaper økt fokus på energieffektivisering, rehabilitering, sirkulær økonomi og annen ressursutnyttelse, for eksempel spillvarme.

Innenfor energisektoren er fokuset på å redusere etterspørsel og det er aksept for lavere økonomisk vekst. Utvikling og ny næring skapes i hovedsak i andre sektorer enn fornybar energiproduksjon. Fortetting og urbanisering leder til mer effektive systemer for transport og energiforsyning.

CCS kommersialiseres før 2030 og sentraliserte løsninger i lokalmiljøet eller byer spiller en stor rolle i energisikkerhet og energiforsyning. Hydrogenproduksjon med CCS og kraftproduksjon fra naturgass med CCS spiller en rolle i det europeiske kraftsystemet og norsk økonomi avhenger av dette. Avfallsforbrenning og varmeproduksjon med CCS spiller en viktig rolle i omstillingen av storbyene.

Samtidig er det mindre aksept for transmisjon og store naturinngrep i Norge, men unntak av eksportkabler og offshore vind.

Personlige CO₂-kvoter diskuteres, men politikerne foreslår å etablere markeder for disse, gjerne på europeisk nivå. EU Emission Trading System -Personal etableres for alle europeiske land.

1.4 Klimapanikknasjon / Climate panic nation

English

Norway, Europe, and the rest of the world spend the next ten years discussing climate solutions. There is broad agreement that the 1.5-degree target will be reached with the help of negative emissions and CCS. In 2030, two important and surprising events take place. First, large parts of the Antarctic ice melt in a short time as a result of changes in ocean currents. At the same time, we see sudden and dramatic climate changes that turn parts of Europe into the desert, while other parts are experiencing huge increases in precipitation or disappearing into the sea. CCS technology does not succeed on a scale necessary to deal with the crisis.

All western countries introduce a climate minister who is the supreme decision-making authority over government and parliament. This leads to strong state control in the period 2030-2050.

In the new situation, energy demand drops dramatically, but so does energy production since coal and gas are phased out overnight. New nuclear power plants are being planned but will not be in place before 2050.

For end-users, this means rationing and all end-user flexibility is exploited. We see a dramatic increase in wind and solar in a short time from 2030. Transmission and energy storage become important. Hydrogen plays a major role in absorbing surplus production.

In Europe, energy deficits lead to the nationalization of energy systems and markets and to focus each on its own country and resources. Central control and regulation stand strong. In Norway we see the merging of NVE + Statnett + Enova + Statkraft + Equinor. The focus is on the maximal exploitation of resources, but it comes too late. All measures are implemented: energy efficiency, recycling, waste heat, renewables, circular economy, rationing.

Norwegian

Norge, Europa og resten av verden bruker de neste 10 årene på å diskutere klimaløsninger. Det er bred enighet om at 1,5 gradersmålet vil nåes ved hjelp av negative utslipp og CCS. I 2030 skjer 2 viktige og overraskende hendelser. Først smelter store deler av isen ved Antarktis på kort tid som en følge av endringer i havstrømmer. Samtidig ser vi brå og dramatiske klimaendringer som gjør deler av Europa om til ørken, mens andre deler får enorme økninger i nedbør eller forsvinner i havet. CCS teknologien lykkes ikke i en skala som er nødvendig for å håndtere krisen.

Alle vestlige land innfører en klimaminister som er øverste beslutningsmyndighet over regjering og storting. Dette fører til sterk statlig styring i perioden 2030-2050.

I den nye situasjonen går energietterspørselen dramatisk ned, men det samme gjør energiproduksjon siden kull og gass fases ut over natten. Nye atomkraftverk prosjekteres, men de kommer ikke på plass for 2050

For sluttbrukere betyr dette rasjonering og at all sluttbrukerfleksibilitet tas ut. Vi ser en dramatisk økning av vind og sol på kort tid fra 2030. Transmisjon og energilagring blir viktig. Hydrogen spiller en stor rolle for å ta av overskuddsproduksjon.

I Europa fører energiunderskudd til nasjonalisering av energisystem og marked og fokus på egne land og ressurser. Sentral styring og regulering står sterkt. I Norge ser vi sammenslåing NVE + Statnett + Enova + Statkraft + Equinor. Fokuset er på maksimal ressursutnyttelse, men det kommer for seint. Alle tiltak gjennomføres: energieffektivisering, gjenvinning, spillvarme, fornybar, sirkulær økonomi, rasjonering.

2 Introduction – The link between the models

Pernille Seljom (IFE), Igor Sartori (SINTEF Community)

FlexBuild uses a set of models to provide insights on the future role and value of end-use flexibility available in buildings from a Norwegian energy system perspective. To address this complex topic, we use mathematical models to systemize and concretize dependencies and competition in the future energy system. Nevertheless, since there is no one perfect model that can capture all related issues, our approach is to use a set of different models who have their own specific strengths. However, the challenge of using numerous models is that these models need to be harmonized and linked in an adequate manner to provide reasonable project insight.

An energy system covers the production, distribution, and end-use of energy. Consequently, the energy system captures the interaction and competition between different energy sources, e.g., between electricity and district heat, as well as the competition between technologies, e.g., between wind and solar power, with more intermittent renewable electricity generation and end-use electrification, the dependencies between the various sectors of the energy system increases. Each of the four FlexBuild models has different sectoral coverage, and consequently captures different aspects of the future energy system.

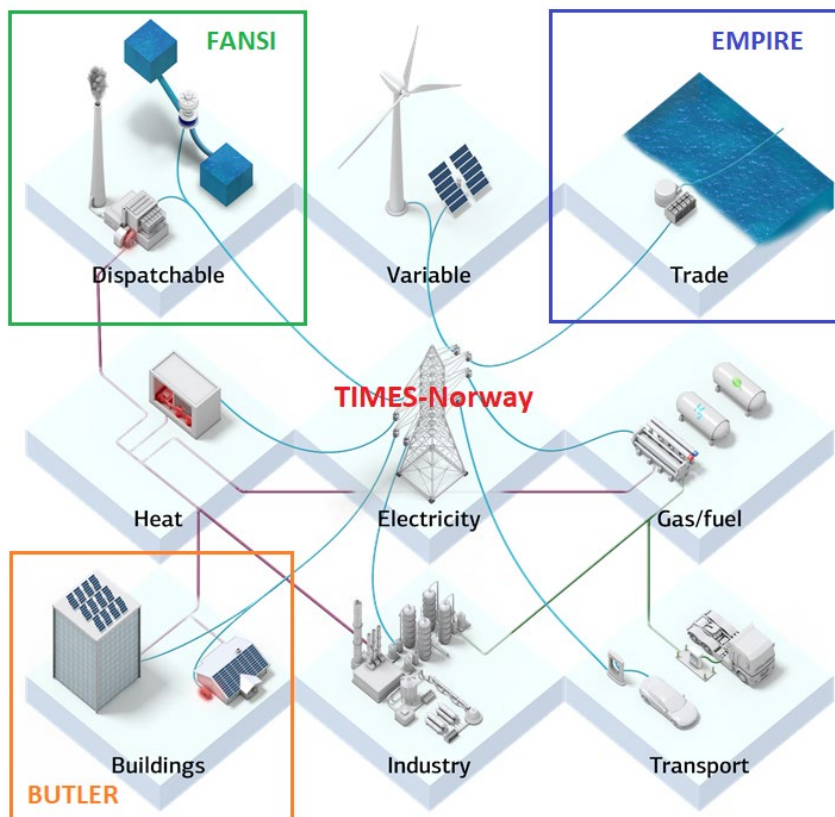

Figure 1: Illustration of sectoral coverage of the various FlexBuild models

Figure 1 gives an illustration of the sectoral coverage of the various FlexBuild models. Three of the models cover parts of the Norwegian energy system, BUTLER, FanSi, and EMPIRE, whereas TIMES-Norway covers all parts and relationships of the energy system. Models that covers sub-parts of the energy system can include more detail than holistic energy system models, such as TIMES-Norway, due to computational complexity. In FlexBuild, we use the sector-specific models to provide details of specific parts of the energy system, whereas the energy system model will be used to cover the connections between the different parts of the energy system. This includes the interaction between the Norwegian building, transport, and industrial end-use sectors with the Norwegian hydropower and European power market.

BUTLER covers the Norwegian building sector and optimizes the cost-optimal energy system solutions in Norwegian buildings. BUTLER has a detailed characterization of the Norwegian building sector but does not explicitly capture the interaction between the surrounding energy system. For example, the model assumes a given electricity and district heat price and assumes that the implementation of energy efficiency measures or local PV generation in a building does not influence these prices. Furthermore, using BUTLER alone cannot capture the competition and interaction between end-user flexibility in buildings with other flexibility sources, such as the flexibility available in the hydropower, industry, and transport sectors. However, by linking BUTLER with TIMES-Norway, we can capture these dependencies.

The linkage will be designed to analyze how energy solutions in the Norwegian building sector should develop from a socio-economic perspective, and how Norwegian buildings can facilitate cost-efficient decarbonization of the Norwegian energy system. Note that TIMES-Norway also covers the Norwegian building sector but with a coarser detail level than BUTLER. The linkage between the BUTLER and TIMES-Norway will, therefore, be used to address what is the necessary detail level of the building sector in energy system models to give an appropriate representation of end-use flexibility in Norway. Furthermore, since BUTLER optimize from a building perspective, and TIMES-Norway optimize from an energy system perspective, FlexBuild will use the two models to analyze whether there is a mismatch on what energy solutions that is cost-optimal from a building developer perspective compared to a central-planner perspective.

The methodology for linking BUTLER and TIMES-Norway is an ongoing development. For the first project year, the focus has been to harmonize the technology data, demand profiles (heat, hot water, and electricity specific) and solar generation profiles. The resulting electricity prices and district heat prices from TIMES-Norway is also used as an input to BUTLER for the analysis presented below. The next step of the linking between the two models is to develop a bi-directional linking strategy with a clearly defined convergence criterion. An option is to use the demand for electricity and district heat from BUTLER to TIMES-Norway and to use the corresponding energy prices from TIMES-Norway to BUTLER.

Since the regional coverage of TIMES-Norway is limited to the five Norwegian spot price regions, the model does not explicitly capture the interaction with the European power market. This includes how the future Norwegian energy system is influenced by the European power market, and how the Norwegian electricity trade influences the European power market. Since the Norwegian energy system, including the role of end-use flexibility, to a high degree influences with the European power market, these aspects should be covered in the FlexBuild analysis. This is done by linking TIMES-Norway with EMPIRE, a long-term optimization model of the European power and heat market.

The methodology for linking TIMES-Norway with EMPIRE is also an ongoing development. For the first project year, it is used expected electricity prices for countries outside Norway from EMPIRE to TIMES-Norway. This is to ensure that the presented storylines are consistent with the development assumptions of the European power market. The next step is to exchange a set of European power prices with weather-dependent realizations of renewable power generation and electricity demand. This requires that consistent modeling of the renewable electricity generation and demand through the development of weather-dependent stochastic scenarios. For example, it is necessary to ensure wind power in Norway is correlated with, e.g., the wind power in Sweden and Germany. A next step of the

linking between the two models is to develop a bi-directional linking strategy with a clearly defined convergence criterion. It is an option to use the electricity prices from EMPIRE as an input to TIMES-Norway and to use the corresponding electricity trade with Europe from TIMES-Norway as an input to EMPIRE.

To address the FlexBuild objectives, it is necessary to capture the interaction between hydropower and end-use flexibility since Norway has extensive flexibility available in the large hydro reservoirs. With five model regions and wide sectoral coverage, TIMES-Norway has an aggregated representation of the hydropower. In order to assess the inherent flexibility of Norwegian hydropower, the model FanSi is applied. FanSi is an optimization model for power markets with a detailed representation of the Nordic hydropower system, including cascaded hydro courses with numerous reservoirs and power plants. The motivation by the linkage is to ensure that the FlexBuild analyzing considers the characteristics of Norwegian hydropower in an appropriate manner.

Installed generation, transmission capacity, and electricity demand are inputs to FanSi and model results from TIMES-Norway. The first step of linking is to exchange these parameters between the models to simulate the effect of a given storyline on the Norwegian hydropower system. In this way, we can address how various developments of the future energy system influence the operation of the Norwegian hydropower. A next and ambitious step of the linking between the two models is to develop a bi-directional linking strategy with a clearly defined convergence criterion. This linkage is necessary to ensure that the investments of BUTLER, TIMES-Norway, and EMPIRE considers the detailed characteristics of the Norwegian hydropower system.

3 Power system Europe – EMPIRE

Mohammadreza Ahang, Asgeir Tomasgard (NTNU)

3.1 Short description of the EMPIRE model

The EMPIRE, European Model for Power system Investment with Renewable Energy (Skar, Doorman, & Tomasgard, 2014). is a power system investment model, formulated as a multi-horizon (Kaut et al., 2014) stochastic program. It can optimize investments under operational uncertainty and incorporates long-term and short-term system dynamics.

EMPIRE is designed to facilitate decarbonisation studies of the European power system with transmission infrastructure investments. The spatial detail of the model includes all the nationalities represented in the ENTSO-E except Cyprus, Iceland and Montenegro. The granularity of model paves the path to investigate the challenges to mitigate climate change, supported by the European Commission. Figure 2 shows interconnection between countries and each country is represented by one node.



Figure 2: Spatial detail of the EMPIRE model

A large-scale deployment of intermittent production to mitigate climate change imposes challenges regarding the balance between supply and demand. Planning investments of technologies, transmission, and storage systems is affected by short-term uncertainty. EMPIRE is a stochastic programming model, which is able to capture the effect of operational uncertainty on the investment decision.

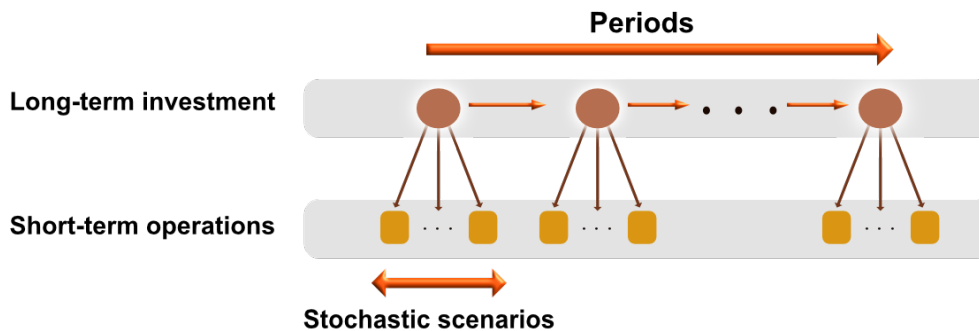

Figure 3: Temporal and stochastic scenario setup in EMPIRE

Figure 3 illustrates the reduced multi-horizon representation of multi-stage stochastic programming problems. In each period, the short-term decisions are in connection with a specific strategic (long-term) decision, while the current operational decisions do not have any influence on the operational or/and long-term decisions from other periods. This assumption helps us to avoid the curse of dimensionality when modeling operational uncertainty in a long-term model. In addition, two types of temporal aggregation are used to reduce the problem size and computational effort. As the main goal of EMPIRE is the long-term expansion of the power system, the dynamic details regarding annual steps are ignored by considering five-year time blocks for investment periods. Furthermore, using a reduced set of operational hours instead of computing a full year dispatch, 8760 hours, can reduce the problem size.

3.2 Generation capacities, energy mix, and Transmission expansion

Figure 4 shows the generation capacity and expected annual production mixes in the scenario with CCS technology. This figure uses the aggregated data and shows the crucial role of wind and solar power until 2060 in consistence with European environmental policies. Therefore, it can help us to achieve a long-term commitment to reduce domestic greenhouse gas emissions in the European Union by 80–95 %, relative to 1990 levels.

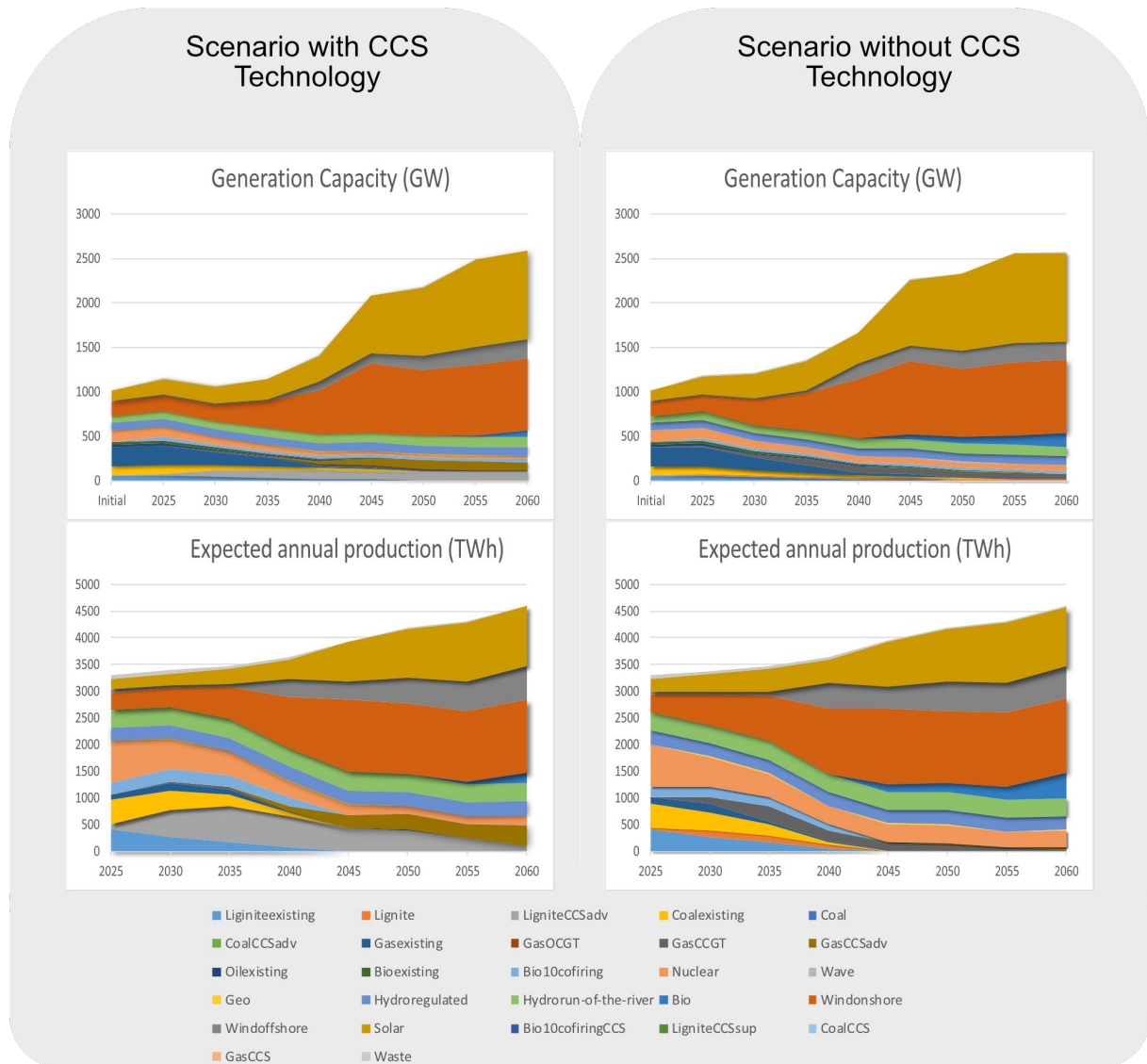

Figure 4: European generation capacity and expected annual production.

In this figure, we have two scenarios include “with CCS” and “without CCS”. As the results show, the role of nuclear and biofuel is important in the absence of CCS technology.

When it comes to the transmission expansion, the most notable country in connection with Norway is Sweden. Figure 4 compares the transmission installed capacity between Norway and other European countries. It shows that transmission expansion is a solution to provide more flexibility and balance demand and supply volume in Europe. Figure 4 indicates the results of the scenario without CCS, while scenario with CCS technology results in a lower level of transmission expansion between Norway and Sweden. It is worth mentioning that EMPIRE is the European power system model, and here we mentioned a part of the entire story that is related to Norway.

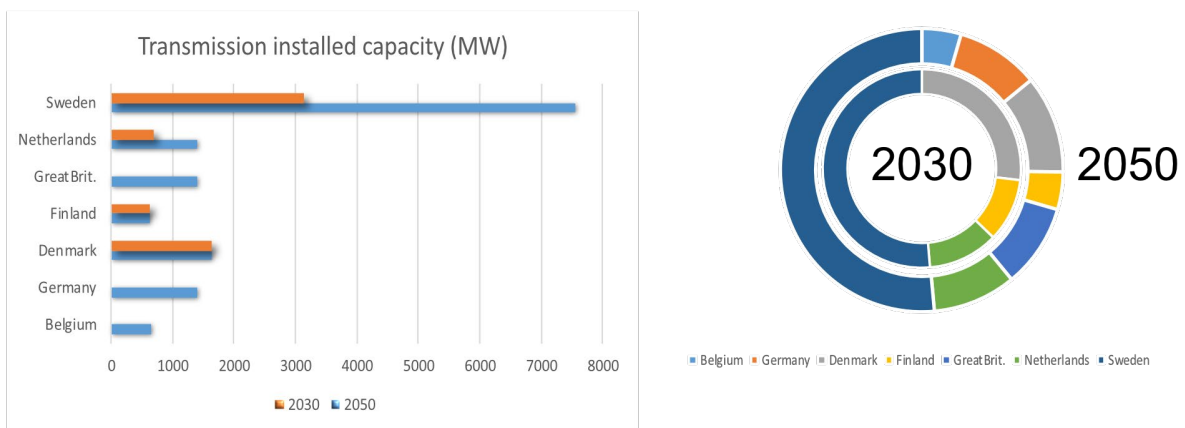

Figure 5: The transmission expansion between Norway and neighboring countries, from 2030 to 2050

3.3 Corresponding “electricity prices”

Electricity prices in EMPIRE reflect the annual shadow price of commodity balance. All commodities in EMPIRE are traded in perfectly competitive markets, and this strong assumption should be taken into consideration.

Figure 6 compares electricity prices from Germany and Sweden that are important players in the power market and electricity trade with Norway. The results show that two scenarios include “with CCS” and “without CCS” can have different effects on the price level. Broadly speaking, including CCS technologies in the model can increase the level of electricity prices in comparison with the “without CCS” scenario. Nevertheless, regarding two different scenarios, electricity prices have different trends from 2030 to 2050.

The results from the “without CCS” scenario in the case of Germany and Sweden show that prices have a downward trend from 2030 to 2050. While the results from the “with CCS” scenario do not follow this pattern, and sometimes prices at 2050 are higher than prices in 2030.

Scenario without CCS Technology

Scenario with CCS Technology

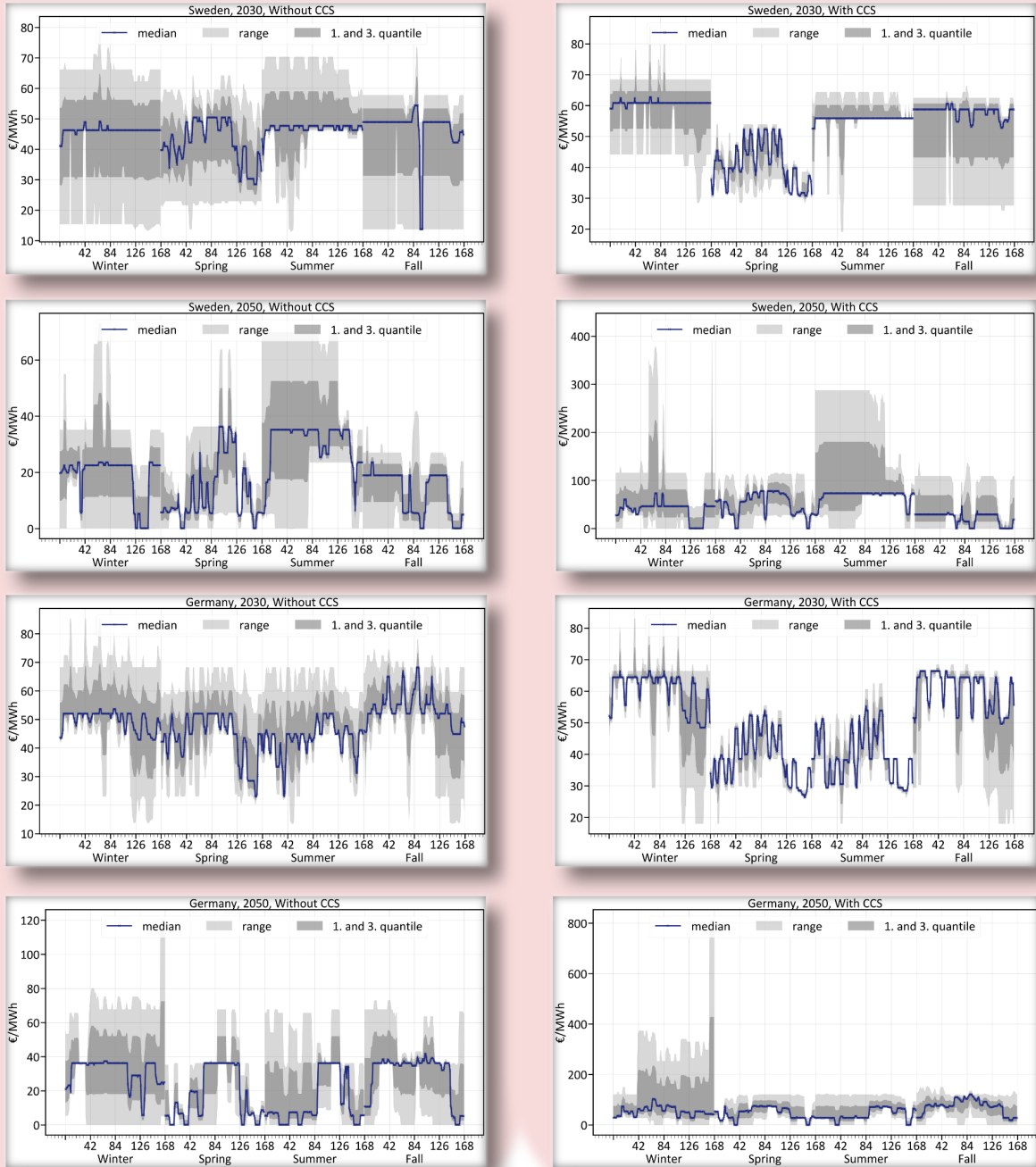

Figure 6: Electricity prices from Sweden and Germany for two scenarios; "With CCS" and "Without CCS"

3.4 References

- Andersen, I. M. (2018). *Stochastic Optimization of Zero Emission Buildings*. Norwegian University of Science and Technology.
- Bagle, M., & Lindberg, K. B. (2019). *Investigation into the impact of thermal energy flexibility on cost optimal design and operation of Zero Emission Buildings*. NTNU.
- Bjelland Eriksen, A. et. al. (2020). *Endringer i nettleiestrukturen*. Retrieved from http://publikasjoner.nve.no/rme_hoeringsdokument/2020/rme_hoeringsdokument2020_01.pdf
- Bøhn, T. I., Palm, L. T., Bakken, L., Nossun, Å., & Jordell, H. (2012). Potensial- og barrierestudie: Energieffektivisering i norske yrkesbygg. Bakgrunnsrapport. *Enova Report 2012-01.2*.
- Dorfner, J. (n.d.). urbs: A linear optimisation model for distributed energy systems — urbs 1.0.0 documentation. Retrieved March 18, 2020, from <https://urbs.readthedocs.io/en/latest/>
- Drammen Fjernvarme AS. (2020). Produksjonsanlegg. Retrieved May 5, 2020, from <https://df.no/om-oss/produksjonsanlegg>
- Fortum Varme. (2020). Fjernvarmenettet i Oslo. Retrieved May 5, 2020, from <https://www.fortum.no/bedrift-og-borettslag/fjernvarme/om-fjernvarme/fjernvarmenettet-i-oslo>
- Kaut, M., Midthun, K. T., Werner, A. S., Tomasgard, A., Hellemo, L., & Fodstad, M. (2014). Multi-horizon stochastic programming. *Computation Management Science*, *11*, 179–193. <https://doi.org/10.1007/s10287-013-0182-6>
- Korpås, M. (2004). *Distributed Energy Systems with Wind Power and Energy Storage*.
- Lien, S. K., Langseth, B., Spilde, D., & Lindberg, K. B. (2018). *LEAP-NORGE 2016*.
- Lindberg, K. B. (2017). *Impact of Zero Energy Buildings on the Power System: A study of load profiles, flexibility and system investments* (Norwegian University of Science and Technology). Retrieved from <https://ntnuopen.ntnu.no/ntnu-xmlui/handle/11250/2450566>
- Lindberg, K. B., Bakker, S. J., & Sartori, I. (2019). Modelling electric and heat load profiles of non-residential buildings for use in long-term aggregate load forecasts. *Utilities Policy*, *58*, 63–88. <https://doi.org/10.1016/j.jup.2019.03.004>
- Lindberg, K. B., Fischer, D., Doorman, G. L., Korpås, M., & Sartori, I. (2016). Cost-optimal energy system design in Zero Energy Buildings with resulting grid impact: A case study of a German multi-family house. *Energy and Buildings*, *127*, 830–845.
- Mitsubishi ZUBA Cold Climate Air Source Heat Pumps/Encore Geothermal. (n.d.). Retrieved March 18, 2020, from <https://web.archive.org/web/20141021195035/http://encore-geothermal.ca/sustainable-solutions/air-source-heat-pumps/>
- Mjønes, C., Pettersen, F. V. H., Kristoffersen, B. S., Birkeland, B. M., Essen, J. von, Haaberg, K. J., & Myhre, L. (2012). Potensial- og barrierestudien. Boliger. *Enova Report 2012-01.1*.
- Nett, H. (n.d.). Nettleiepriser og tariffer - privat- og næringskunder - Haugaland Nett. Retrieved February 14, 2020, from <https://haugaland-nett.no/kunde/nettleie/nettleiepriser-tariff/>
- Nordic Energy Technology Perspectives 2016 - Cities, flexibility and pathways to carbon-neutrality. International Energy Agency. <https://www.nordicenergy.org/wp-content/uploads/2015/12/Nordic-Energy-Technology-Perspectives-2016.pdf>
- Norgesnett. (n.d.). Nettleie - Norgesnett. Retrieved February 14, 2020, from <https://norgesnett.no/nettleie/#/effektbasert-nettleie/>
- Oslofjord Varme AS. (2020). Produksjonsanlegg Sandvika. Retrieved May 5, 2020, from <https://www.oslofjordvarme.no/anlegg/sandvika/>
- Pedersen, L., Stang, J., & Ulseth, R. (2008). Load prediction method for heat and electricity demand in buildings for the purpose of planning for mixed energy distribution systems. *Energy and Buildings*, *40*(7), 1124–1134. <https://doi.org/10.1016/j.enbuild.2007.10.014>
- Rocha, P., Kaut, M., & Siddiqui, A. S. (2016). Energy-efficient building retrofits : An assessment of regulatory proposals under uncertainty. *Energy*, *101*, 278–287. <https://doi.org/10.1016/j.energy.2016.01.037>
- Sandberg, N. H., Sartori, I., Vestrum, M. I., & Brattebø, H. (2017). Using a segmented dynamic dwelling stock model for scenario analysis of future energy demand: The dwelling stock of Norway 2016–2050. *Energy and Buildings*, *146*, 220–232. <https://doi.org/10.1016/j.enbuild.2017.04.016>
- Seljom, P., & Tomasgard, A. (2015). Short-term uncertainty in long-term energy system models - A case study of wind power in Denmark. *Energy Economics*, *49*, 157–167. <https://doi.org/10.1016/j.eneco.2015.02.004>

- Skar, C., Doorman, G., & Tomasgard, A. (2014). The future European power system under a climate policy regime. *ENERGYCON 2014 - IEEE International Energy Conference*, 318–325. <https://doi.org/10.1109/ENERGYCON.2014.6850446>
- SN/TS 3031:2016. (n.d.). Retrieved March 18, 2020, from <https://www.standard.no/no/Nettbutikk/produktkatalogen/Produktpresentasjon/?ProductID=859500>
- Spilde, D., & Skotland, C. (2016). *Hva betyr elbiler for strømmettet ?*
- Staffell, I., Brett, D., Brandon, N., & Hawkes, A. (2012, November). A review of domestic heat pumps. *Energy and Environmental Science*, Vol. 5, pp. 9291–9306. <https://doi.org/10.1039/c2ee22653g>
- Statkraft. (2020a). Varmeproduksjon Ås 2019. Retrieved May 5, 2020, from <https://www.statkraftvarme.no/om-statkraftvarme/vare-anlegg/norge/Aas/>
- Statkraft. (2020b). Varmeproduksjon Gardermoen 2019. Retrieved May 5, 2020, from <https://www.statkraftvarme.no/om-statkraftvarme/vare-anlegg/norge/gardermoen/>
- Statkraft. (2020c). Varmeproduksjon Moss 2019. Retrieved May 5, 2020, from <https://www.statkraftvarme.no/om-statkraftvarme/vare-anlegg/norge/Moss/>
- Statkraft. (2020d). Varmeproduksjon Sandefjord 2019. Retrieved May 5, 2020, from <https://www.statkraftvarme.no/om-statkraftvarme/vare-anlegg/norge/sandefjord/>

4 Building sector Norway – BUTLER

Karen B. Lindberg, Marius Bagle (SINTEF Community)

4.1 Introduction: Brief Model Description

BUTLER (BUilding's opTimaL Energy design and opeRation) is a building energy system optimization model, initially developed in (Lindberg, 2017), and further developed in (Andersen, 2018) and (Bagle, 2019). The model optimizes investments and operations concurrently by minimizing costs. The model has hourly time resolution and maybe run in a deterministic mode with 8760 hours, or in a stochastic mode with 5 to 21 scenarios for four representative weeks. As opposed to general energy system modeling tools that allow for determining the time of investment, the investment decision in BUTLER is at the start, i.e., year zero. There are two reasons for this; first, a building needs to invest in an energy system within the building at the time of construction, and second, to keep computational and programming complexity low.

The main benefits of BUTLER are the detailed description of technology operation¹ at the building level, as well as the financial perspective of the building owner. General energy system modeling tools minimize costs from a national perspective where taxes are considered as an income and subsidies as expenditures. BUTLER investigates the optimal investments from the building owner's perspective, allowing for analyzing incentives that are influenced by energy taxes and grid tariffs as actual costs, this especially important for e.g., investments of local PV and batteries.

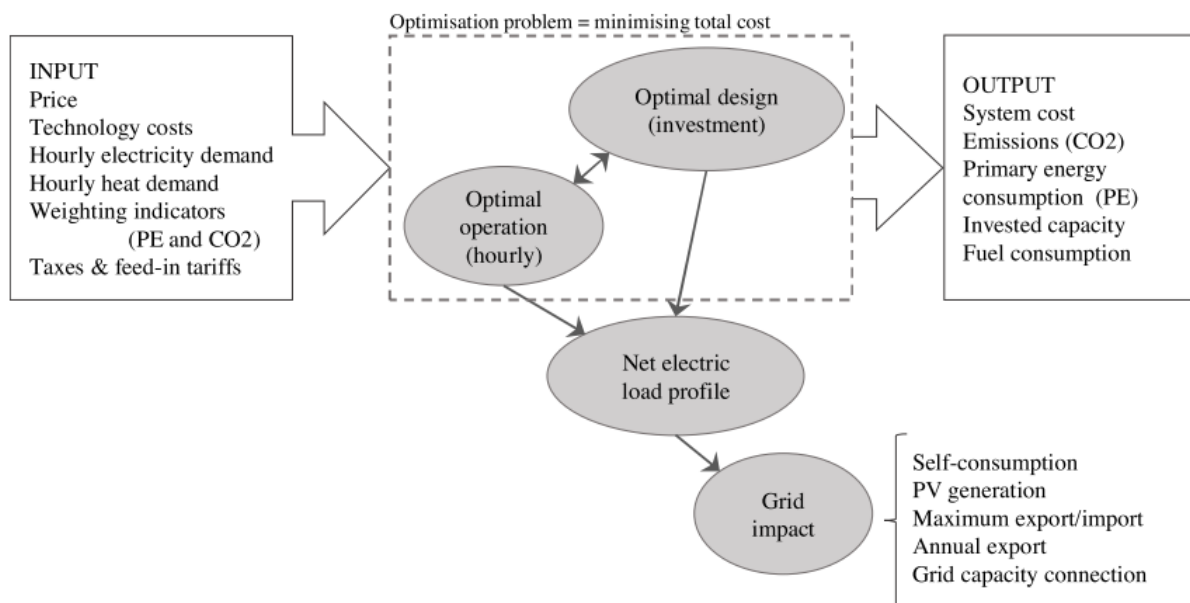

Figure 7: Model description with main inputs and outputs. Grid impacts are consequences of the optimal design and operation. (Lindberg, Fischer, Doorman, Korpås, & Sartori, 2016)

Objective function

The objective is to minimize the total discounted energy costs of the building over its entire lifetime. The lifetime is set exogenously, often used is 40 years or 60 years, even though some buildings may live more than 160 years. The investment decision happens in year one, and hence, postponed or later investments are currently not possible.

Investments are decided by finding the least-cost *combination* of energy technologies and their installed *capacity*. Investment costs are formulated as a discontinuous linear function, with the discontinuity representing a fixed cost representing the installation cost of the technology. The lifetime of technology determines the number of reinvestments required. For example, if the building's lifetime is 60, a heat pump with 25 years life will be reinvested twice. At the end of the building's lifetime, the third heat

¹ This is important especially for heat pumps (HP) and combined heat and power units (micro-CHP).

pump has a salvage value of 15 years, which is corrected for in the technology's discounted investment cost.

The operational costs are calculated in detail for one year, multiplied with the lifetime, and discounted back to the net present value. There are two modes of operation; deterministic and stochastic.

- Deterministic model:
 - The time resolution is 8736 hours reflecting 52 weeks á 168 hours, and sequential operation.
- A stochastic model accounting for short-term uncertainties:

We have built a two-stage stochastic programming tool (inspired by (Rocha, Kaut, & Siddiqui, 2016; Seljom & Tomasgard, 2015)) where the first-stage variables are the investment decision, and the operational decisions are the second-stage variables. Due to the possible high number of scenarios, the number of operational hours was reduced to four representative weeks (winter, spring, summer, fall). The time resolution is still hourly. Hence the total number of hours equals #scenarios*4 weeks*168 hours/week and could range from 3 360 to 14 112 hours, depending on the number of scenarios.

Model enhancements

Model enhancements presented in this report includes both structural changes and energy technology improvements:

Structural improvements

- Heating distribution system within the building:
 - Two modes are possible: waterborne heating system (WB) and point source heating (PS)
 - There is a separate set of heating technologies available for each of them
- Heat demand is split in two:
 - Space heating demand (SH) and domestic hot water demand (DHW)

Energy Technology improvements

- New technologies included:
 - air-to-air heat pumps (A2A) and battery
- Improved modeling of
 - the air-sourced heat pump (ASHP) and ground-source heat pump (GSHP)
- The thermal mass of the building envelope
 - Building internal thermal energy storage (BITES)
- Costs of refurbishment
 - Post-insulation and waterborne heating system (floor heating and/or radiators)

Aggregation procedure

- Aggregating results from BUTLER to a regional net-electric load profile

4.2 Model structure

4.2.1 Building categories

In Norway, the building types may be categorized in different ways. The register of buildings (Matrikkelen) defines 9 residential and 11 non-residential building types, whereas Statistics Norway (SSB) uses the international NACE coding principles of economic activity. Therefore, the energy statistics published by SSB follows the 21 NACE codes according to the economic activity carried out within the building, whereas the Matrikkelen provides data distributed on building types. This causes challenges when analyzing energy use in buildings as some building types (especially offices) contain several NACE economic activities.

Based on evaluations made in 'Potensial og barrierestudien', the size of the Norwegian building stock was estimated to 356 mill m² in 2010, of which 73% are households. The energy statistics on the other hand, show that the energy end-use in buildings (sum of 'Private households' and 'Private and public services') is about 80 TWh², of which approximately 58% is used in households. Hence, even though service buildings only account for 27 % of the building stock, they are responsible for 42 % of the energy use in buildings.

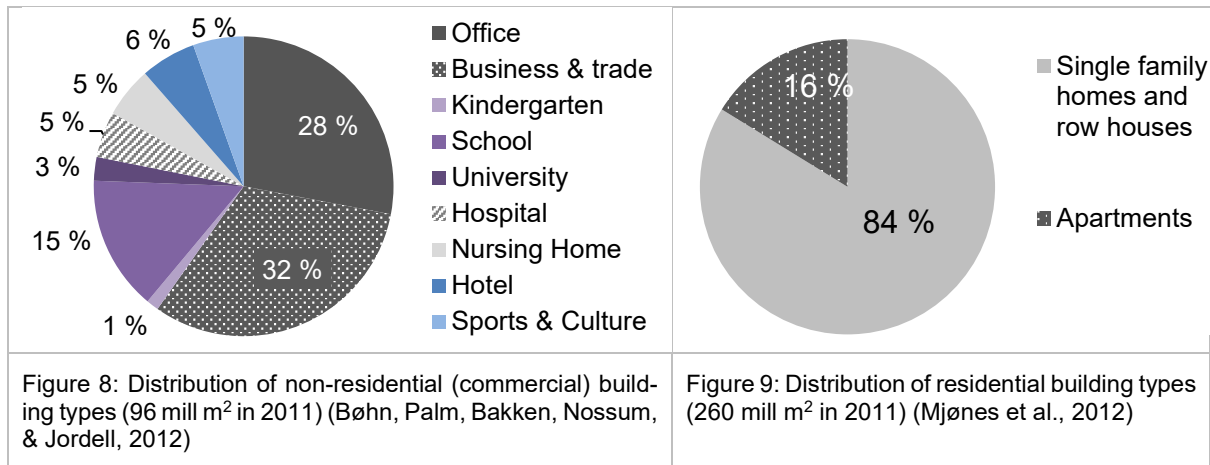

Within the BUTLER modeling framework, we run the model for an individual building, followed by a procedure that aggregates the energy load on a local, regional or national scale, according to stock information (in mill m²). The aggregation procedure is elaborated in Section 0.

4.2.2 Regular and efficient buildings

The technical standard of a building has a high impact on its energy needs and thus its energy consumption. The technical regulations in Norway, TEK10, ensure new buildings to have a high technical standard. However, existing buildings built in the 1960s or 1970s or even in the early 1900s do not have the same standard.

Although we know the annual energy demand per building standard, the hourly energy demand is less known. One of the main inputs to BUTLER is the load profiles for heat and electric specific demand. To investigate the impact of district heating and heat pumps on the power system, the hourly heat demand must be separated from the electric specific demand. This is challenging in Norway as most buildings are heated by electricity, and thus separating what is used for heating from the electric specific demand is challenging.

In FlexBuild, we use hourly load profiles obtained from (Lindberg, Bakker, & Sartori, 2019; Pedersen, Stang, & Ulseth, 2008) that uses hourly measurements from over 100 buildings. Regression models are established that predicts the heat load and electricity load profiles for one year. The regression models are sampled under an umbrella called **PROfet** and take the outdoor temperature as an input variable. This makes it possible to predict load profiles for different geographical locations and climatic years. As explained in Section 5.5, BUTLER takes demand profiles for each of the five regions in Norway (NO1 to NO5), and for a TMY climatic year (in deterministic mode) or for 5-30 different climatic years (in stochastic mode). Please also confer Chapter 5.4 for more details.

² Numbers for 2017 from Statistics Norway, <https://www.ssb.no/energi-og-industri/statistikker/energibalanse>

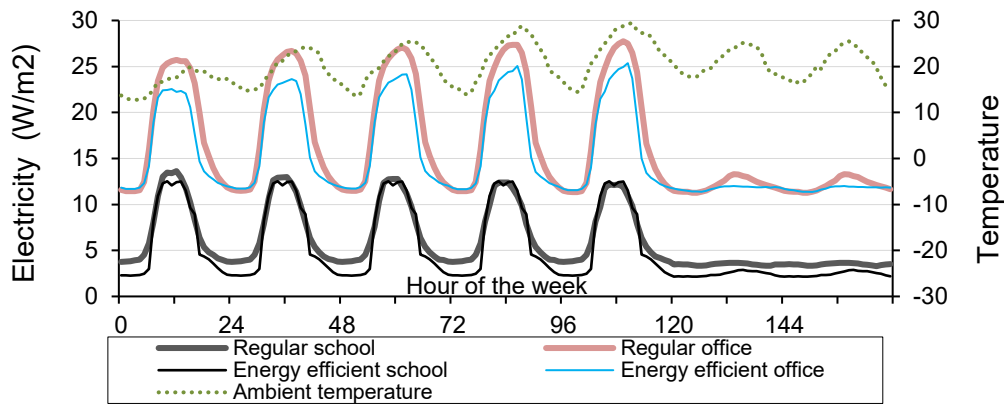

Figure 10: Electric load profiles predicted by PROfet for a week in summer. Regular (thick) and efficient (thin) schools (black) and office buildings (blue). (Lindberg et al., 2019)

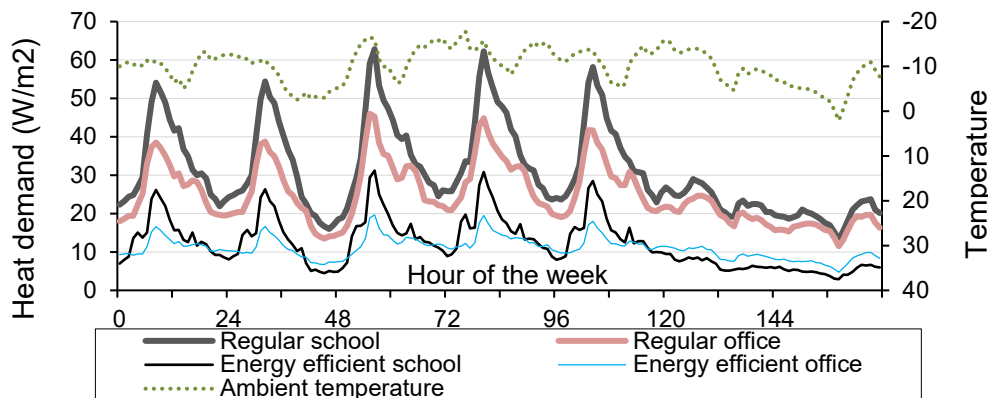

Figure 11: Heat load profiles predicted by PROfet for a cold week in winter. Regular (thick) and efficient (thin) schools (black) and office buildings (blue). (Lindberg et al., 2019)

4.2.3 Building's heat distribution system

A building may be heated either by point-source heating technologies that are installed separately in every single room. This includes, e.g., electric radiators, fire-place, and air-to-air heat pumps. This is the most common way to heat residential buildings in Norway. Alternatively, the building may be heated through a waterborne heat distribution system that transfers heat to the room through floor heating or radiators. The technologies that heat the water is usually placed in a separate technical room in the basement, and often provides heat to meet the hot tap water demand as well as the space heating demand.

In FlexBuild, the BUTLER-model has been extended so that buildings with point-source heating technologies are modeled. Table 1 presents the technologies available for the two modes: 'waterborne (WB)' and 'point-source (PS)'.

A building with a *waterborne heat distribution system* may be heated by different boilers such as electric boiler or pellets boiler, or by air-to-water or brine-to-water heat pumps (see Figure 12). A building that does not have a waterborne heating system is heated by so-called *point-source heating technologies*, meaning that they provide heat from one point source and cannot heat several rooms, e.g., fireplace or an air-to-air heat pump (see Figure 13).

Table 1 Energy technologies modeled in BUTLER

	Heat distribution system within building	
	Waterborne (WB) (radiators and/or floor heating)	Point-source (PS)
Electric Radiator		X
Fireplace (FP)		X
HP air-to-air (A2A)		X
HP air-to-water (ASHP)	X	
HP brine-to-water (GSHP)	X	
Bio boiler (BB)	X	
District heating (DH)	X	
Electric Boiler	X	X
Hot water tank (HWT)	X	X
Heat storage (HS)	X	
Battery (BA)	X	X
Solar cells (PV)	X	X

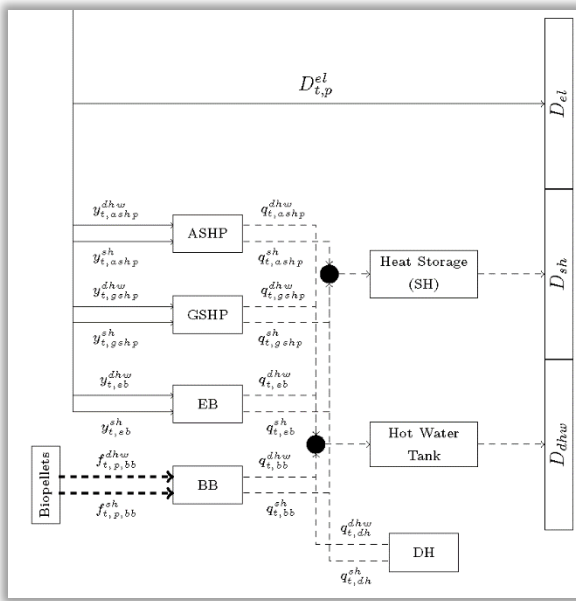

Figure 12: Model structure with a *waterborne heating* system.

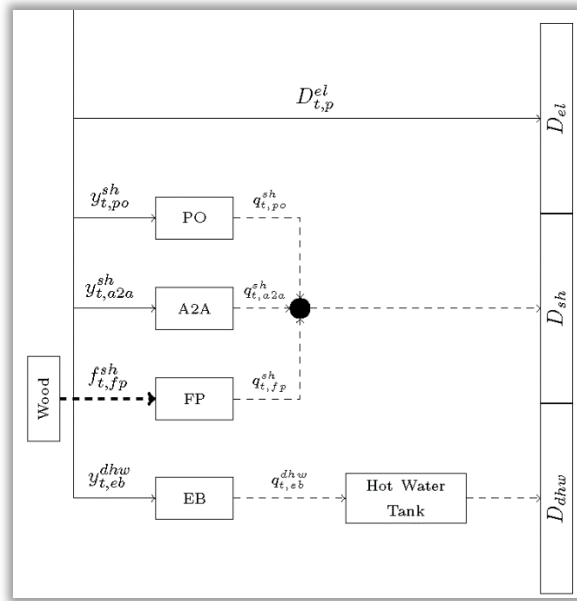

Figure 13: Model structure with *point source heating* technologies.

4.2.4 Total BUTLER modes

Summed up, the total number of individual buildings to be optimized in BUTLER depends on the number of building categories (i), building standard (j), technology modes dependent on whether a waterborne heating distribution system is present (n), for all regions (r). As illustrated in Figure 14, the buildings are classified according to the building category, the technical standard, and the heat distribution system within the building. Currently, the model is set up for $3*(1*3)*1 = 9$ sub-models:

- Three building categories (average service building (3000 m2), single-family home (160 m2) and apartment block (1600 m2)): $i = 3$
- One building standard (R, E): $j = 1$
- Three technology modes (wb_DH, wb, ps): $n = 3$
- Five regions (NO1 to NO5): $r = 5$

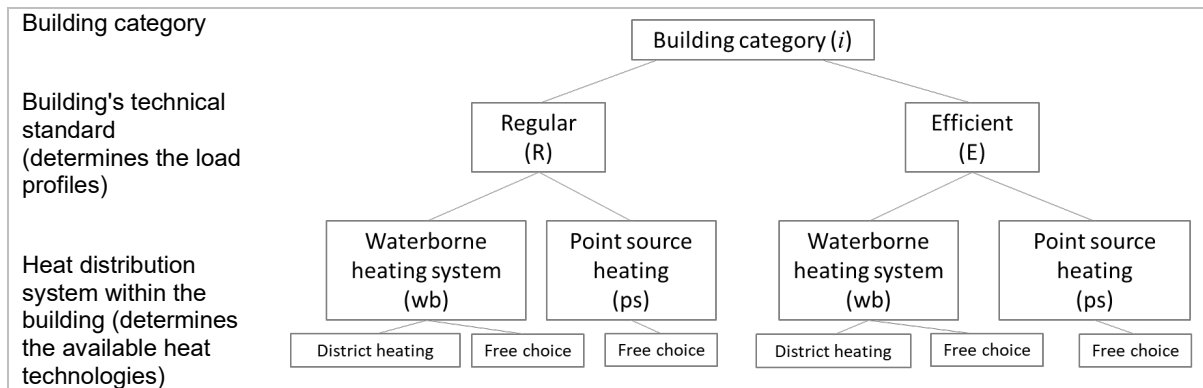

Figure 14: Overview of the BUTLER framework

4.3 Technology Enhancements

4.3.1 Heat pumps

In BUTLER, there is a set of heat pumps that can be chosen as heating technologies, depending on whether the system is of type waterborne or point-source. For the waterborne model, the following two heat pumps are available:

- GSHP, ground-source heat pump (brine-to-water)
- ASHP, air-source heat pump (air-to-water)

The coefficient of performance for a heat pump depends on the temperature of the heat source T_{source} , and the supply temperature of the heating system T_{supply} , often denoted as delta T, ΔT . For the GSHP, T_{source} equals the temperature in the ground, here assumed to be constant throughout the year, whereas the ASHP T_{source} equals the ambient temperature, which has hourly variations. The supply temperature for domestic hot water equals 55-65 C, but the supply temperature for space heating depends on the outdoor temperature (following a heating curve) and whether the heat is transferred via radiators or floor heating.

Further, for the ASHP, the heat provided by the heat pump is reduced when the ambient temperature declines, and ΔT becomes too high. Therefore, the maximum available capacity at each timestep is constrained based on the outside temperature. Here, we have used **the indicative performance values for different heat pump types from the Norwegian standard NS/TS-3031:2016 (“SN/TS 3031:2016,” 2016) (shown in Figure 15)**. For ambient temperatures above 7 degrees, these heat pumps are assumed to produce heat at their rated output. For temperatures below -15 degrees, we assume that the effective heat output drops to zero. This may be revised at a later stage.

Staffell, Brett, Brandon, & Hawkes (2012) is a review paper that contains similar polynomials to the ones presented here.

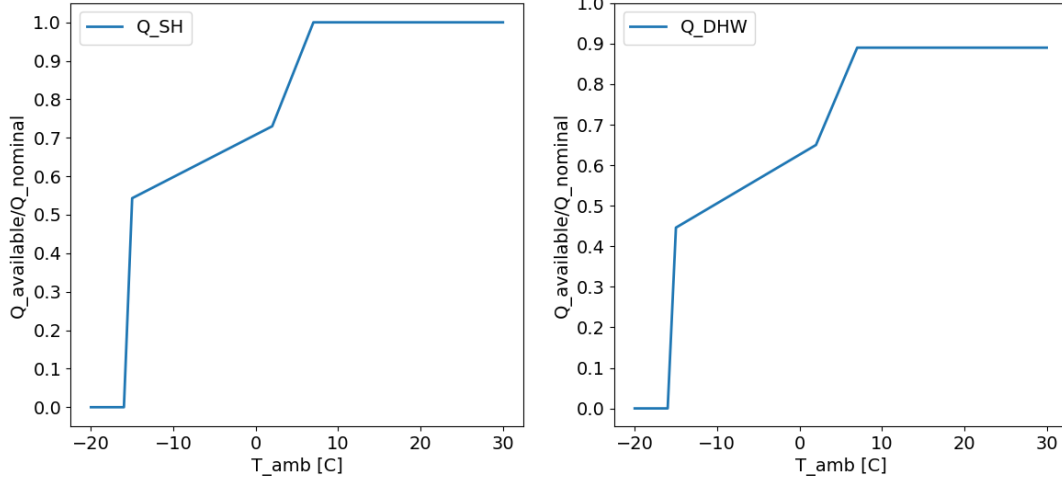

Figure 15: ASHP restrictions on delivered heat for space heating (left) and domestic hot water (right). (“SN/TS 3031:2016,” 2016)

For the point-source BUTLER-model, the only available heat pump is the air-to-air (A2A) heat pump. This technology can only be used for space heating demand. The calculation of the COP of this technology is done in a cruder manner, creating a polynomial directly from COPs claimed by Mitsubishi for their ZUBA Cold Climate air source heat pump (“Mitsubishi ZUBA Cold Climate Air Source Heat PumpsEncore Geothermal,” n.d.). An issue with this manner of calculating COPs is that they are unrealistically high during the summer. In BUTLER, this is alleviated by the fact that the space heating demand usually is quite small in this period, which means that little heat is produced with these COPs (cooling is not considered in the model yet). Similar to the ASHP, the delivered heat from the A2A heat pump is constrained by the outdoor temperature using the same standard NS/TS-3031:2016 (“SN/TS 3031:2016,” 2016).

4.3.2 Battery (without binaries)

Batteries may turn out to be an essential enabler of flexibility in the future energy system. Therefore, we consider it to be important that the battery model in BUTLER is as accurate as possible, without increasing the run time significantly. Prior to the start-up of FlexBuild, the battery was modeled with binaries, ensuring the battery to avoid being charging and discharging at the same time. Running the deterministic model in full creates (8736-time steps) creates $8736 \cdot 2 = 17472$ extra binary variables to ensure either charging or discharging of the battery. A high number of binary variables increases the computational overhead of a MILP-problem. Therefore, an alternative way to describe the battery, without explicitly forcing the mutual exclusivity of charging and discharging was implemented.

The new formulation is inspired by (Korpås, 2004) and introduce a net charging variable, y_t^s :

$$y_t^s + y_t^{ch} - y_t^{dch} = 0 \quad \forall t \in \mathcal{T}$$

Furthermore, we introduce a variable y_t^{dump} , which absorbs any surplus production of electricity that cannot be charged to the battery, consumed or exported. This yields the following balance for electricity:

$$D_t^{el} = y_t^{imp} - \sum_{i \in \mathcal{J}_{el}} y_t^i + \sum_{i \in \mathcal{J}_{prod}} y_t^i + y_t^s - y_t^{dump}$$

Despite this notational trick, there is no a priori guarantee that charging and discharging of the battery does not take place in the same time step. However, we consider the model speed-up to be more important than any edge cases that may arise with the rare special circumstances needed for simultaneous charging and discharging. Besides, we have created a simple function to do a column-wise XOR-check on the resulting time-series of the variables y_{dch} and y_{ch} , such that any such cases can be flagged a posteriori.

4.3.3 Grid tariffs

The current grid tariff structure in Norway consists of two schemes, one for small customers (mostly households) and one for large customers (mostly non-residential buildings, and industry companies). For small customers, energy pricing is the current grid tariff, whereas large customers with a power demand exceeding 100 kW, are charged with a monthly measured maximum tariff (Haugaland Nett, 2020), or the average of several measured maximums within a month (Norgesnett, 2020).

Before the startup of FlexBuild, the only grid tariff model implemented in BUTLER was 'energy pricing,' which is the current scheme for all residential electricity customers. To get a better understanding of how different grid pricing models can influence the utilization of flexibility in buildings, it is necessary to implement additional schemes. NVE published on February 5th, 2020 a proposal for new grid tariff schemes (Bjelland Eriksen, 2020), including the following three high-level models:

Daily measured peak power (*målt effekt*) / Max power:

- The customer pays for the highest measured power outtake from the grid in a day. Since the AMS only captures power on an hourly resolution (?), this means that the measured power outtake is an hourly average [kWh/h]. This fits well with the time resolution of BUTLER.

Power subscription (*Abonnert effekt*):

- The customer pays for the maximum power normally needed. When this limit is exceeded, a premium must be paid for the penalty volume, i.e., the electricity imported above the subscription limit. Somewhat inaccurately, this can be compared to a data subscription for a cell phone. In theory, this subscription can be done on any time horizon (daily, weekly, monthly), but in order to diminish the need for customer intervention, NVE envisions a yearly subscription (?).

Fuse differentiated (*Sikringsdifferensiert nettleie*):

- The customer pays for the maximum possible power outtake, i.e. based on the size of the main fuse.

The input-data of the five different structures of the grid tariff is based on data from NVE and on available data from Hafslund Nett. Please confer Table 2.

Table 2: Grid tariffs. Input data and notation

Name	Description	Value	Domain
Energy pricing			
C^{fxd_ep}	Fixed-term [€]	118.4	Single-valued
$C_m^{spe_ep}$	Energy term [€/kWh]	0.046	Single-valued
y_t^{imp}	Electricity import [kWh/h]	Variable	T
Monthly Peak power			
C^{fxd_pp}	Fixed-term [€]	404.04	Single-valued
$C_m^{spe_pp}$	Energy term [€/kWh]	$0.0069 \mathbf{w}^3, 0.0039 \mathbf{s}^4$	M
$C_m^{pty_pp}$	Power term [€/kW]	$14.85 \mathbf{dw}^5, 7.92 \mathbf{sw}^6, 2.28 \mathbf{s}$	M
y_t^{imp}	Electricity import [kWh/h]	Variable	T
$y_m^{max_imp}$	Max measured power [kWh/h]	Variable	M
Power subscription			
C^{fxd_ps}	Fixed-term [€]	108	Single-valued (None)
C^{spe_ps}	Energy term [€/kWh]	0.005	Single-valued
C^{var_ps}	Subscription cost [€/kW]	54	Single-valued
C^{pty_ps}	Penalty cost [€/kWh]	0.08	Single-valued
y_t^{imp}	Electricity import [kWh/h] in t	Variable	T
γ^{max_ps}	Subscription limit [kW]	Variable	Single-valued
y_t^{pty}	Penalty volume [kWh/h] in t	Variable	T
Daily Peak power			
C^{fxd_dp}	Fixed-term [€]	148	Single-valued
$C_d^{pty_dp}$	Power term [€/kW]	$0.18 \mathbf{w}, 0.1192 \mathbf{s}$	D (If d in \mathbf{w} , else d in \mathbf{s})
C^{spe_dp}	Energy term [€/kWh]	0.005	Single-valued
y_t^{imp}	Electricity import [kWh/h]	Variable	T
$y_d^{max_imp}$	Max measured power [kWh/h]	Variable	D
Fuse differentiated			
C^{fxd_fd}	Fixed-term [€]	175	Single-valued
C^{var_fd}	Subscription term [€/kW]	34.3	Single-valued
C^{spe_fd}	Energy term [€/kWh]	0.05	Single-valued
γ^{max_fd}	Subscription limit [kW]	Variable	Single-valued
y_t^{imp}	Electricity import [kWh/h]	Variable	T

4.3.4 EV-demand (driving demand per week)

Due to the increasing penetration of electric vehicles (EVs), both worldwide and in Norway, the charging of these vehicles will take up a larger share of the demand for electricity. Since a large amount of these EVs will be charged either at home or while at work, the electricity demand for charging will become a part of the building's energy demand. As flexible charging options will constitute one of the largest flexible resources for buildings, this energy demand is included in the BUTLER model.

A challenge that arises in this regard is the lack of available data on EV charging. In the future, we assume that EVs will have larger batteries with less frequent charging needs. Therefore, instead of (or in addition to) limiting ourselves to inaccurate data on charging profiles, we have formulated the need for EV charging demand on a weekly (or semi-daily) basis, instead of using load profiles, and let BUTLER decide when to charge the EVs.

In BUTLER we have classified the weeks for winter and summer in which the operation is to be optimized since the electricity use per km varies significantly between summer and winter (initial

³ **w**: Winter, nov.-mar.

⁴ **s**: Summer, apr.-oct.

⁵ **dw**: Deep winter, dec.-feb.

⁶ **sw**: Shallow winter, nov., mar.

numbers 0.13 kWh/km summer 0.30 kWh/winter (Spilde & Skotland, 2016)) due to electrochemical effects.

Based on numbers from Statistics Norway, the average weekly driving distance for a personal car is 232,8 km [16]. The statistics reflect the current Norwegian car fleet which consists of approximately 90% fossil-fuelled cars [ref.], so the driving distance is under the assumption that EVs will have similar driving patterns as fossil cars.

The constraint is defined per week. First, the average weekly temperature is found. Then, the working hours (here defined as hours 8 to 16 in weekdays) are filtered out of the set of time steps. Finally, it is stated that the sum of EV charging in these filtered time steps must be greater than or equal to the driving demand. In the end, a restriction is placed on the charging rate; as this is usually either 3,6 kW or 7,2 kW in domestic parking spots, we set it temporarily to 5 kW (as an average of the two).

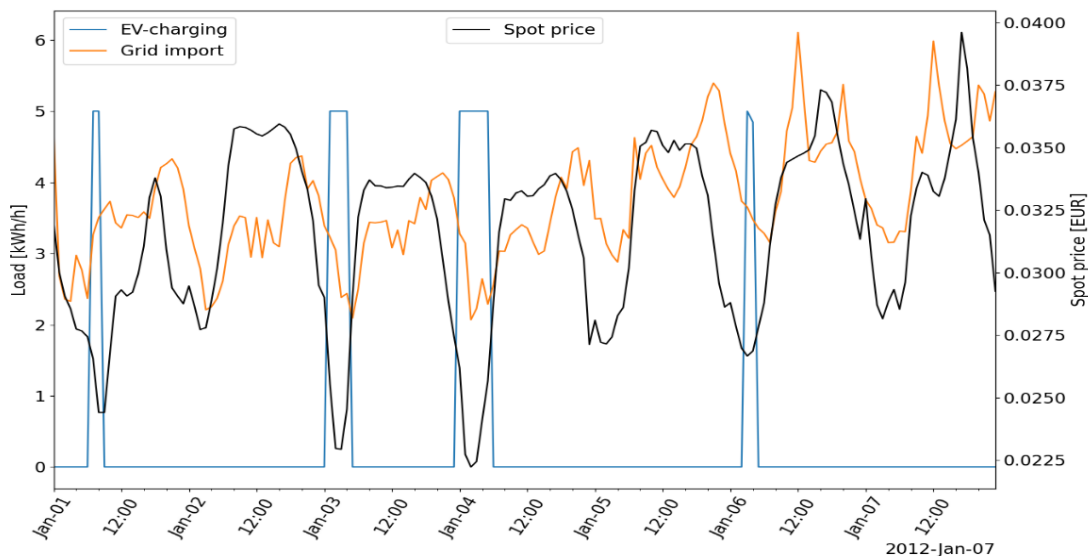

Figure 16: EV-charging profile

A test run is shown in Figure 16. The vehicle is charged at night and early in the morning, which is in accordance with the constraints and fits well with the spot price of electricity (black line).

4.3.5 Renovation (insulation & VBV)

The choice of renovation, such as post-insulation and/or waterborne heating, is included in the long-term storylines, and not a part of the cost-optimal choice within BUTLER. The penetration of renovation will be determined by model runs in TIMES and partly by evaluating the renovation potential based on Nina H. Sandbergs Ph.D. work (Sandberg, Sartori, Vestrum, & Brattebø, 2017).

4.3.6 Stochasticity/stochastic database

Substantial work has been carried out to prepare the BUTLER model for the stochastic optimization mode. This involves categorizing input data such as load profiles into representative four weeks of the year within each price zone. We define the following limits for winter, spring, summer, and fall:

- Winter: Dec. 3rd – Mar. 4th
- Spring: Mar. 5th – Jun. 3rd
- Summer: Jun. 4th – Sep. 2nd
- Fall: Sep. 2nd – Dec. 2nd

In addition, Dec. 30th, 31st and Feb. 29th (in leap years) are removed to get exactly 52 weeks in each year. The load profiles are now ready to be used in a scenario selection process, and subsequently as input parameters in a stochastic framework. The associated temperature profiles are also included in

this dataset. PV-profiles are provided by IFE (Renewables.ninja is used). Spot prices for all these years can be accessed through the FTP-servers of NordPool.

A script for creating scenario trees with adjacent probability is created. Now we are ready to populate them with scenarios selected from the scenario generation work of WP1 in the second year of the project. A simple method that could be used as a reference case is k-means clustering developed in (Andersen, 2018)

4.4 Input and output data

In this chapter, the input parameters Load profiles, spot price, solar radiation, COPs for heat pumps, are presented. Since the BUTLER framework includes several building categories and types/standards, only some selected buildings will be presented.

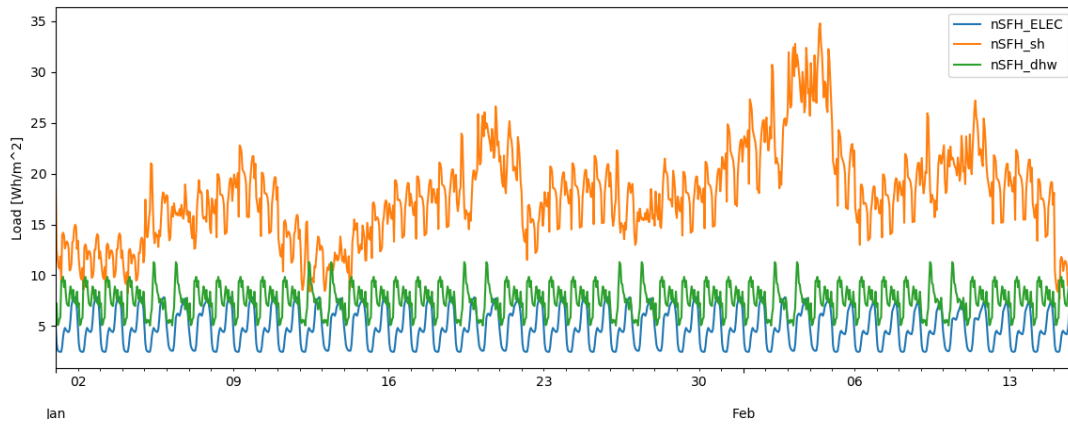

Figure 17: Load profiles for regular SFH (1st January – 15th February)

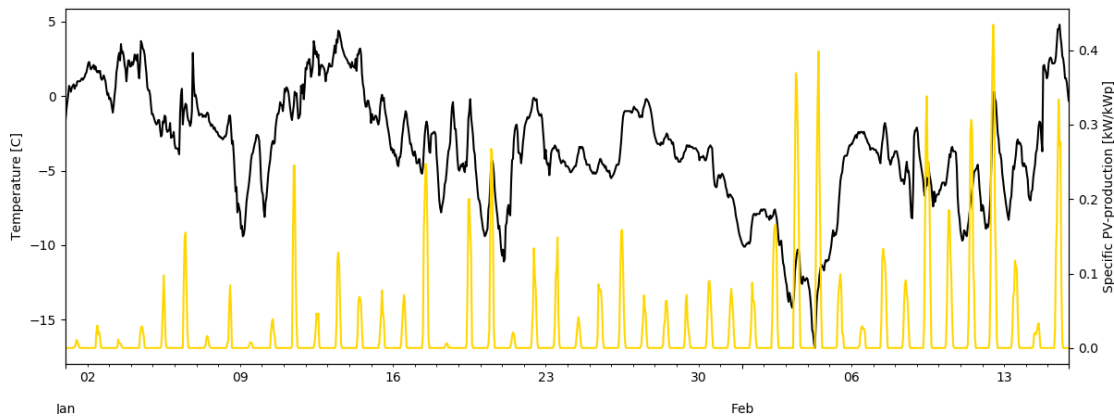

Figure 18: PV production profiles and outdoor temperature (1st January – 15th February)

Figure 17 shows the load profiles for a "regular" Single Family House (nSFH). Starting from the bottom, we have the specific electric load, representing the electricity use of a building not related to space or water heating, i.e., lighting, electric appliances, and electronic devices. The green profile shows the domestic hot water (DHW) profile. This load shows a similar periodicity as the electric specific load, but with the peak shifted to the left (in the morning). Finally, the red curve depicts the space heating load. This is the most energy-demanding load in the plotted period, as it is during winter. It also exhibits a strong correlation with the outdoor temperature, which is plotted in Figure 13, along with the specific PV-production [kW/kWp]. As expected, solar production is relatively low in winter.

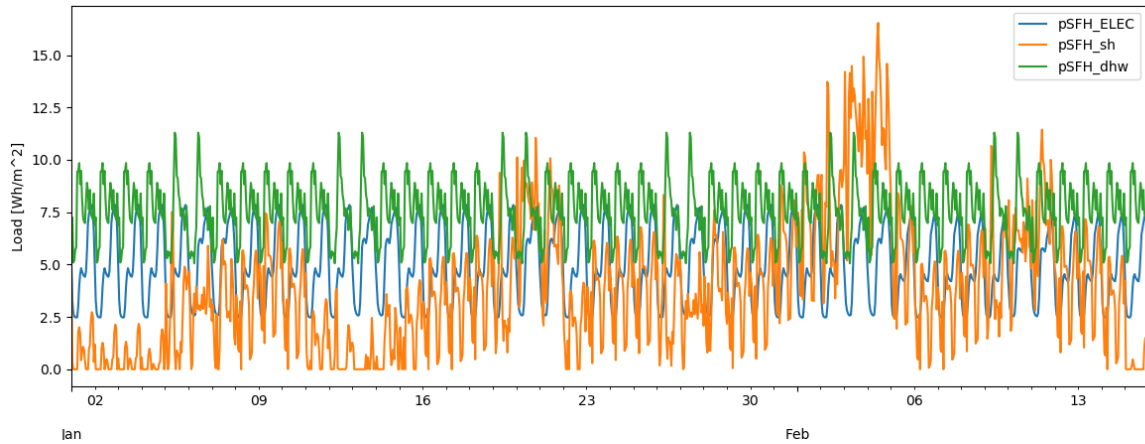

Figure 19: Load profiles passive SFH

To illustrate the difference between regular and energy-efficient building standard, the load profiles for a passive Single Family House (pSFH) is plotted in Figure 14. Here, the space heating load is lower than the load for both DHW and electric specific demand, except when the temperature reaches -10°C and below. This drastically reduced space heating demand might lead to other optimal energy systems than for the regular SFH.

We can also look at the load profiles for the Office category to investigate the DHW load. Generally, we would expect the hot water usage in offices to be quite low compared to the other loads, since people generally do not shower at the office. By inspecting the plot, we see that this in fact is the case. The DHW load fluctuates around 2 Wh/m^2 , while the SH-load varies between ca. 8 and 35 Wh/m^2 .

Finally, some remarks must be made about units for the load profiles. Before each optimization run, the load profile is scaled up by the conversion factor $\frac{\text{arch_area}[\text{m}^2]}{1000[\frac{\text{Wh}}{\text{kWh}}]}$, where arch_area is the archetype area.

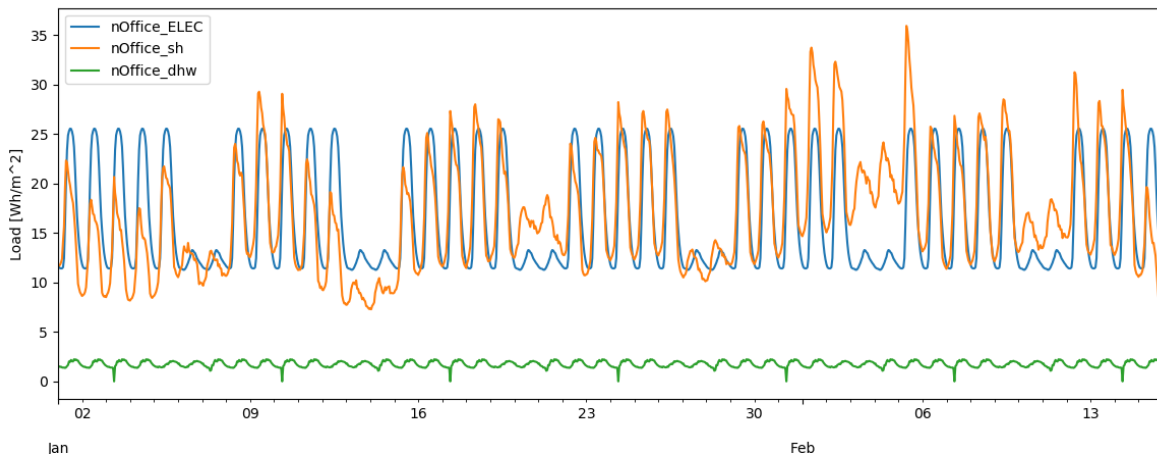

Figure 20: Load profiles for a regular Office building

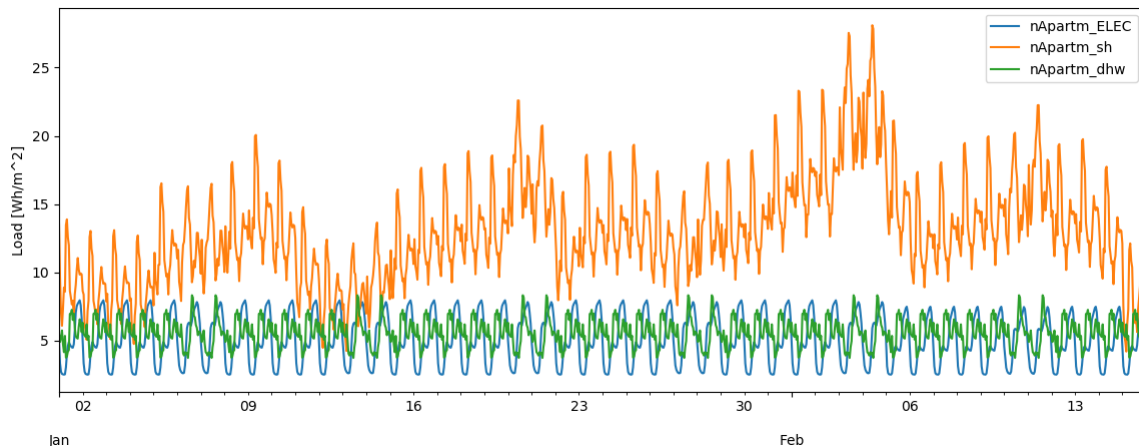

Figure 21: Load profiles for a regular Apartment block

Since BUTLER shall be used for large-scale energy system optimization and analysis in FlexBuild, it is necessary to build a functionality that enables storing and reading to and from the model. Furthermore, plotting of optimization results should also be as effortless as possible. The plotting is done in Python, and the optimization model is implemented in Pyomo. Hence, an interface between the two is necessary. Fortunately, such an interface already exists in the linear programming software package *urbs* developed at the Technical University of Munich. This module, *pyomoio* (Dorfner, 2020), is used in the data management framework of BUTLER.

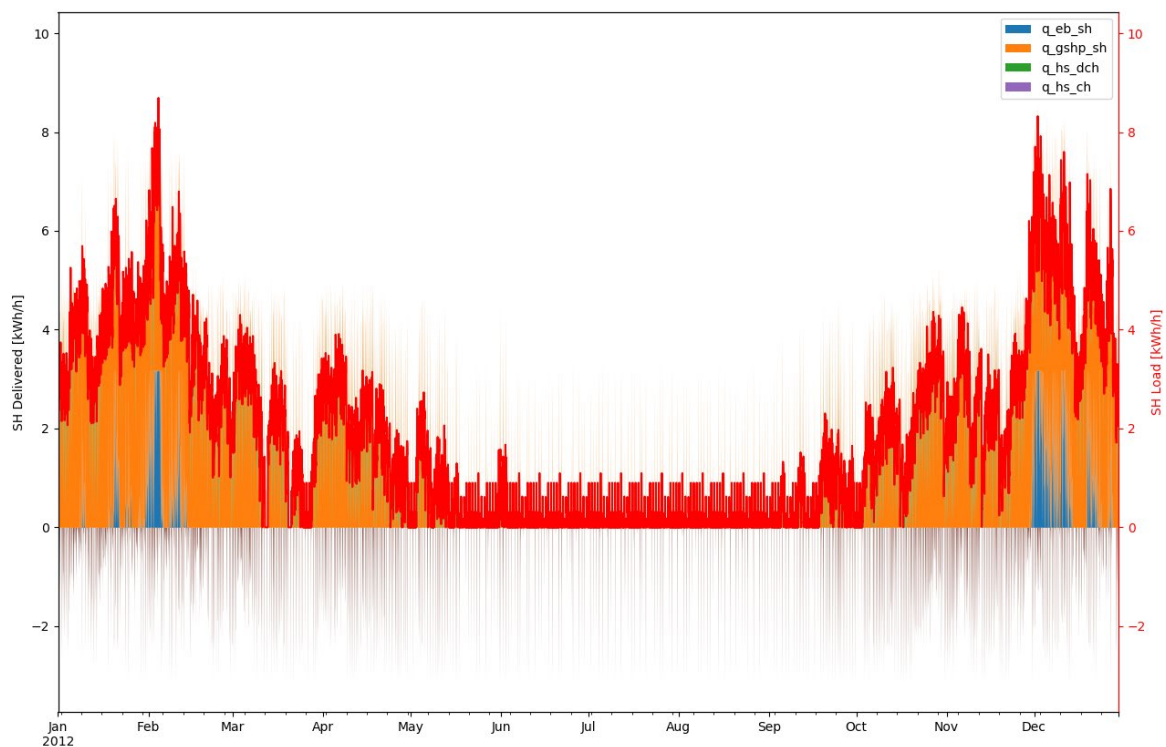

Figure 22: Annual plot example for space heating load

Scripts for creating result plots for each of the three demand types (electric specific load, space heating load, DHW load) have been developed. Figure 22 show an example of a result plot for space heating demand. Further, plots are also created for the coldest week of the year, which is found by taking the highest accumulated space heating load, assuming the space heating load as a proxy for the outside temperature.

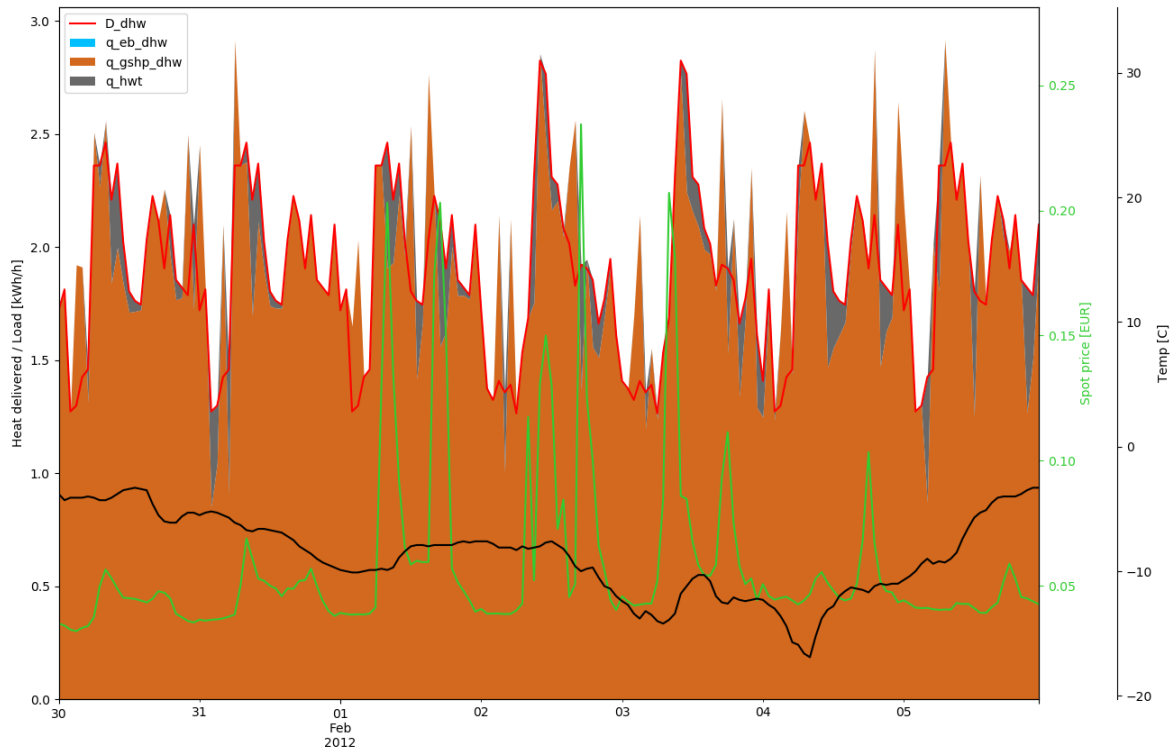

Figure 23: Coldest week plot example for DHW load

A quick analysis of Figure 23: The GSHP covers almost the entire DHW-load (with a little buffering from the hot water tank (HWT), even in the coldest week of the year, due to the stable source temperature in the ground. Further, the usage of the buffer capacity in the hot water tank coincides with the peaks in the spot price. In the hours prior to a peak, the HWT is charged, followed by a discharge of heat in the hours after. This is an example of an idealized Model Predictive Control (MPC).

4.5 Aggregation

To evaluate the results of BUTLER (carried out on a building level) on the regional or national level, we apply an aggregation procedure. The methodology is presented in the following.

BUTLER minimizes total discounted costs for a single building. A BUTLER model is run for one archetype building representing each of the 11 building categories presented in Section 5.2.1. The investment costs of the technologies are scaled according to building size, i.e., small, medium, and large (see details in Section 5.2.2). The BUTLER model provides optimal investments and optimal operation of the building's energy system. One of the outcomes is the net-electric load profile (see Figure 1), in kWh per hour over the entire year (8760 hrs). The net electric load profile equals electricity used minus electricity produced at the building level and might also show negative values in certain hours, reflecting the export of electricity to the distribution grid.

The aggregation procedure takes the net electric load profile from BUTLER, divides it by the size of the archetype building, creating a relative net electric load profile in kWh/hr per m². Secondly, the load profiles are aggregated according to the size of the building stock within each region. In FlexBuild, we have defined five regions in Norway, one for each bidding zone of the power market; NO1 to NO5.

The aggregation process is carried out after the optimization.

To complete the aggregation procedure, data describing the building stock is required. More specifically, estimates on the total square meters of each building category within each region have been provided by the NVE (Lien, Langseth, Spilde, & Lindberg, 2018).

4.6 Results /input to TIMES

4.6.1 Impact of new power tariffs on a single residential building

The first results of analyzing the impact of the new power tariffs introduced by NVE are found in the following. (The details of the proposed power tariffs where introduced Chapter 5.3.3).

A case study of a single-family house with a size of 250 m² was investigated with the following three configurations:

- Reference case (*REF*): Regular standard (R), with point-source heating (ps) using direct electric heating and an electric hot water tank → marked with red in the graphs
- Case 2 (*rglASHP*): Regular standard (R), with waterborne heating (wb) using an air-source heat pump for both space heating and DHW → marked with blue in the graphs
- Case 3 (*effASHP*): Efficient standard (E), with waterborne heating (wb) using an air-source heat pump for both space heating and DHW → marked with green in the graphs

BUTLER finds the installed capacity for the heating technologies for each of the three cases by minimizing the total costs. The operation is also optimized according to the fluctuating spot price and the power tariff in question.

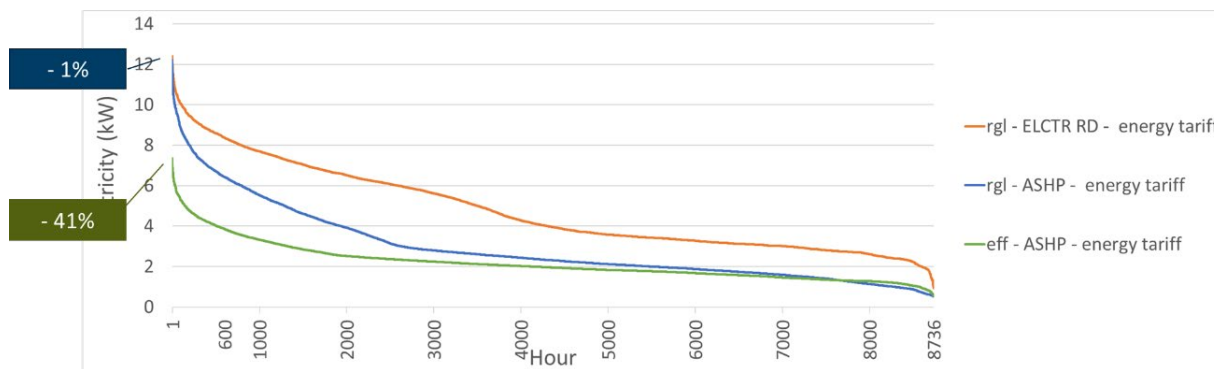

Figure 24: Duration curve of the *net electric load* profile with the current energy tariff for SFH for cases 1, 2, and 3.

Figure 24 shows the load duration curve of the net electric load profile of the three cases when using the current energy tariff pricing scheme. The area below the lines sums to the annual electricity consumed, and we see that a regular existing SFH heated by electric radiators would benefit from installing an ASHP, but the peak load is only reduced by 1%. Hence, this investment is beneficial for the house owner, but the grid owner (DSO) still needs to have a grid capacity that can handle the peak loads. In case 3, the house has done substantial upgrading by insulating and tightening the building envelope, and both the yearly electricity consumption, as well as the peak load is reduced by respectively 50 and 41%.

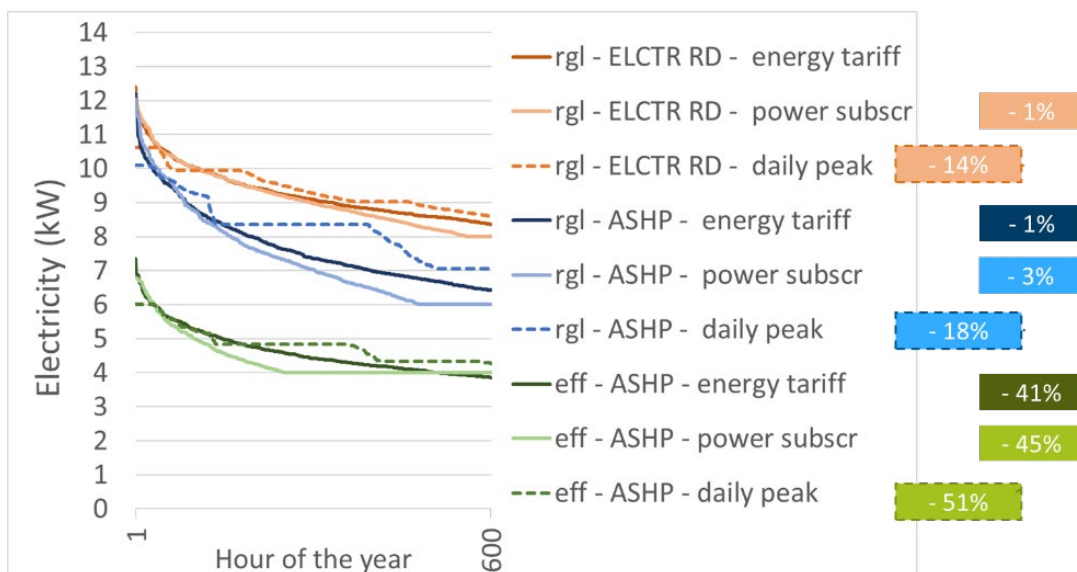

Figure 25: Duration curve of the *net electric load* profile with the alternative power tariffs: current energy pricing (solid dark line), power subscription (solid light line), and daily measured peak (dashed line). The boxes to the right show the reduction of the maximum peak load relative to the reference case.

The power tariffs proposed by the NVE seek to give incentives to reduce the peak power for each customer. Figure 25 shows that the subscription tariff (light colors) keeps the load below the subscribed limit (here: 8 kW for *REF*, 6 kW for *rglASHP*, and 4 kW for *effASHP*), as long as possible, but once it is necessary to go above this limit, the model seems to be indifferent to how much the limit is violated. Hence, the peak load is only reduced by 1%, 1%, and 8% relative to the peak load with current energy pricing (solid dark line) for each of the three cases *REF*, *rglASHP* and *effASHP*, respectively. Results for the daily measured peak tariff are shown with dashed lines. With the daily measured peak tariff, there is a stronger incentive to keep the peak load as low as possible in all hours, and the peak load is reduced by respectively 14%, 17% and 18% for *REF*, *rglASHP*, and *effASHP* compared to the peak load with current energy pricing for each of the cases. Why do these peak load reductions occur? The answer lies in the flexibility of the heat storage that the waterborne heat distribution system offers, in addition to the domestic hot water tank. To explain the mechanisms in play, we here take a closer look at the space heating demand of the *rglASHP* case. Figure 26 and Figure 27 show the operation of the technologies covering the space heating demand in the *rglASHP* case. In addition, the building also uses electricity for DHW and electric specific demand, which will together determine the total net electric load of the building (see Figure 28).

Figure 26 shows an hourly operation for a week in winter for *rglASHP* with a subscribed power tariff of 6 kW. The temperature (black line) hits below -15°C on the 6th day, making the air-source heat pump⁷ (blue area) unable to operate, and the space heating demand (red line) is solely covered by the electric top-up coil (brown area). What is interesting to observe is the use of heat storage (a grey area), which is charged when the electricity prices (green line) is low and discharged when prices are high. However, heat storage is little used to lower the electric peak load. Therefore, our initial results show that a penalty cost of 8 ct/kWh/h (1 NOK/kWh/h) for the power consumption above 6 kW does not give enough incentives for reducing the peak load. In other words, the subscription tariff schemes motivate the user to stay below the subscribed limit as much as possible, but when violating the limit is unavoidable, the user seems indifferent to when it is violated, i.e., regardless of the hour it occurs. Hence, the incentive for reducing the peak load at the peak load hours is very weak with the power subscription tariff scheme.

⁷ The assumption that the ASHP is unable to operate at outdoor temperatures below -15°C is under evaluation and will be improved in the next phase of the FlexBuild research project.

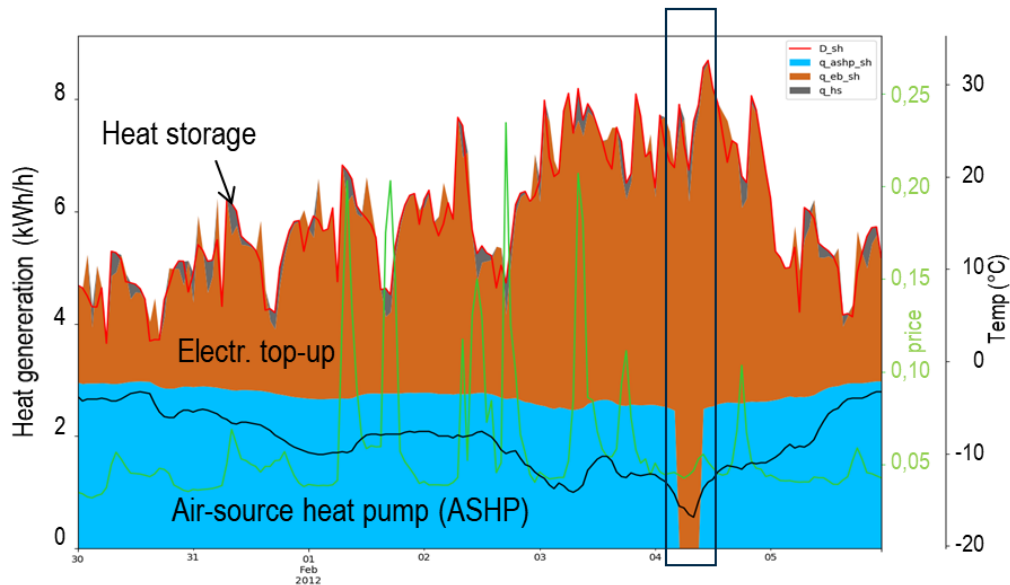

Figure 26: Technologies covering the space heating demand for *rglASHP* with subscription tariff. Peak load occurring on 4th Feb, shown in the black box.

The results of the same case, *rglASHP*, with the daily peak load tariff, is presented in Figure 27. In contrast to the subscription tariff in Figure 26, the heat storage (a grey area) is used more frequently, and in addition to reducing the load at high spot prices, the heat storage is used to reduce the load at the peak load hours. This is confirmed in Figure 28, showing the net electric load of the building. Here, the daily peak tariff is able to reduce the peak load in the hour from 1300-1400, whereas the net electric load with power subscription tariff seems to follow the optimal load of the energy tariff. Going back to Figure 27, the storage is charged in hour no.2 (the orange area is above the red line), and discharged in the hour no. 5, 8, 9, and no.13, keeping the net electric load constant at 10 kW between 0900-1700. Further, to avoid the high electricity price in an hour no. 17, the heat storage is charged the previous hour, and the net electric load is reduced to 7 kW, cf. Figure 28, by discharging the heat storage.

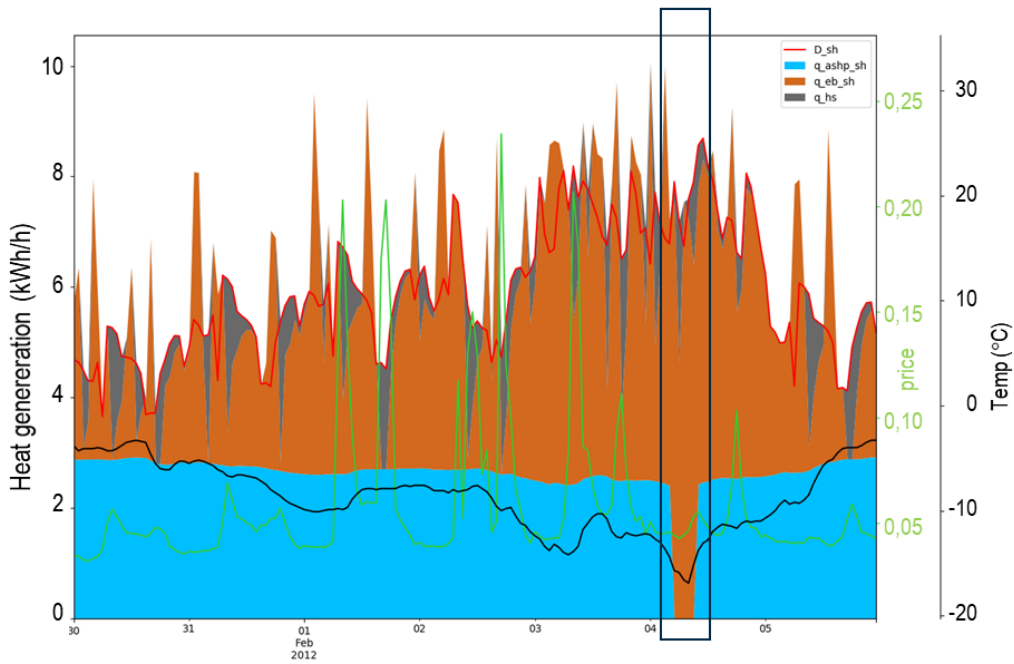

Figure 27: Technologies covering the space heating demand for *rgIASHP* with daily measured peak. Peak load occurring on 4th Feb is shown in the black box.

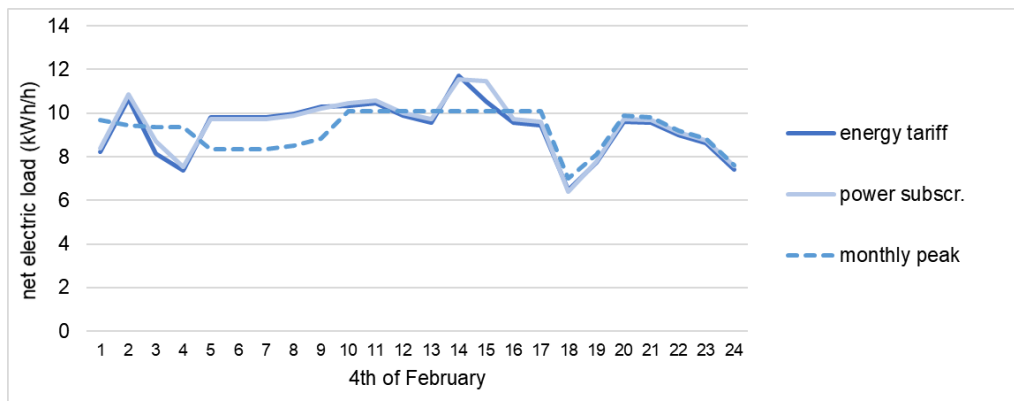

Figure 28: Net electric load on the peak day for *rgIASHP* with three different grid tariffs.

To sum up, the mechanism in play at the building level for peak load reduction through load shifting is very complex. BUTLER is able to take into account the impact of variable electricity prices, variable outdoor temperatures, different grid tariffs, and various long-term investment options. Analyzing the grid tariffs, our conclusions are that the daily peak tariff is able to reduce the net electric peak load to a greater extent than the power subscription tariff.

On the other hand, a further question is whether it is important to keep the peak load of the individual building low, as long as there is enough grid capacity available. For instance, in the previous figures shown, the peak load occurring on the 4th February is a Saturday when the grid is less constrained compared to regular weekdays, and hence, it may be more profitable for the grid to reduce the load in the grid constrained hours. This will be investigated in further work when all the models in FlexBuild are more integrated and linked.

4.6.2 Aggregated results for NO1

A test of the aggregation procedure has been carried out for NO1. For the results to be consistent with TIMES, the waterborne/point-source split from TIMES results for the year 2025 is used. The parameters for the aggregation of NO1 are shown in the tables below.

Table 3: Building stock in NO1, mill m2			Table 4: Aggregation keys NO1 (based on TIMES results)		
Type	Area (mill. m2)	Archetype size (m2 per building)	Type	Point source (PS)	Water borne (WB)
SFH	99.6	160	Residential	0.88	0.12
Apartment block	22.9	1600	Commercial	0.1	0.9
Commercial	42.6	3000			

The buildings that receive heating from district heating in NO1 are based on reported production in 2018/2019. The identified production data from district heating providers in NO1 is presented in Table 5.

Table 5: Providers of district heating in NO1

Provider	Energy production [TWh]	References
Fortum Varme	~1.7	(Fortum Varme, 2020)
Stakraft Varme Ås	0.0267	(Statkraft, 2020a)
Stakraft Varme Moss	0.0405	(Statkraft, 2020c)
Stakraft Varme Gardermoen	0.0689	(Statkraft, 2020b)
Stakraft Varme Sandefjord	0.0265	(Statkraft, 2020d)
Oslofjord Varme	~ 0.22	(Oslofjord Varme AS, 2020)
Drammen Fjernvarme	~ 0.1	(Drammen Fjernvarme AS, 2020)
SUM	2.18	

Combining the information from Table 3 and Table 4, together with the delivered district heat of 2 TWh, yields the distribution key of waterborne heating connected to district heating, waterborne heating, and point-source heating for SFH, apartment blocks and commercial building shown in Table 6. With these distribution keys, it gives an aggregate district heating demand of 2.08 TWh/year, which is sufficiently close to the actual demand in Table 5. Furthermore, the share of residential buildings (SFH + Apartm) with waterborne heating (WB_dh + WB) is 12.04 %, which is a good match with the TIMES keys in Table 4.

Table 6: Aggregation table

Type	WB with district heating	WB	PS	SUM
SFH	0.02	0.05	0.93	1.00
Apartments	0.25	0.09	0.66	1.00
Commercial	0.3	0.6	0.1	1.00

The aggregated heat demand for NO1 is shown in Figure 29 for residential (left) and commercial (right) buildings, respectively. The aggregation is done for all 8760 hours throughout 1 year, but the figures show three days in winter with high load (Sunday, Monday, and Tuesday in February). The peak heat load occurs on Sunday morning (around 10hrs) in the residential buildings at almost 5 GWh/h, whereas the peak in commercial buildings occurs on Monday morning (around 10 hrs) close to 2 GWh/h. The sum peak, however, occurs at around 0800 on Monday.

Further, we see that district heating covers a large part of the heat demand in commercial buildings (yellow), but contributes little in the residential building stock (brown). On the other hand, the total heat demand in residential buildings is larger, and hence the district heat production is almost evenly distributed between the two. Further, we see that the baseload is mainly covered by air-to-air heat pumps in residential buildings, whereas commercial buildings use ground source heat pumps and air-source heat pumps. The peak heat load is mainly covered by direct electric heating ('panelovner og varmekabler') in residential buildings and electric boilers in commercial buildings.

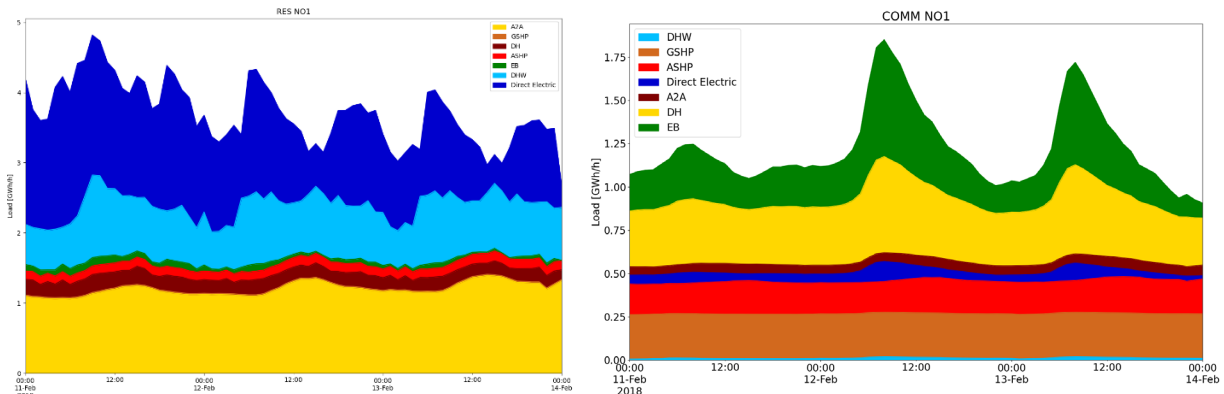

Figure 29: Hourly aggregate heat demand for Residential buildings (left) and Commercial buildings (right) in NO1, by heat technology.

Figure 29 showed heat demand and which technologies provided this heat. Figure 30 shows the sum of the heat demand (blue) and the electric specific demand (red) of the building stock. These are the load profiles used as input to the BUTLER modeling framework, and also to the TIMES model in the first iteration. The black line in the figure shows the aggregate net electric load, which includes electricity for heating purposes. The yellow line shows what the net electric load would look like if there were no district heating in NO1. We see that district heating contributes to lowering the peak net electric load significantly in NO1.

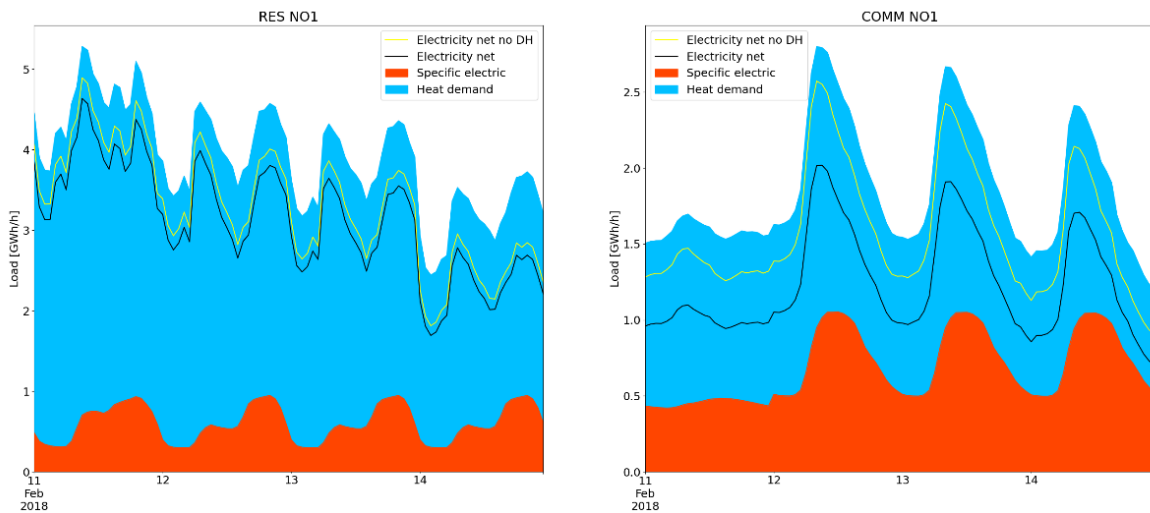

Figure 30: Hourly aggregate energy demand for Residential (left) and Commercial (right) buildings in NO1.

The impact on the net electric load profile with different grid tariffs were presented for individual buildings in Chapter 5.6.1. Here, Figure 31 shows the aggregate net electric load for the same tariff schemes. 'Current' (black line) reflects the current grid scheme for households today, which is 'Energy pricing' (red line). Therefore, the black and red lines are overlapping, and they are the same as the black line in Figure 30. Similar to the results for the individual buildings, we see that it is the 'Daily peak' tariff that provides the lowest peak load on the aggregate level. 'Power subscription' lies between the current and the daily peak tariff.

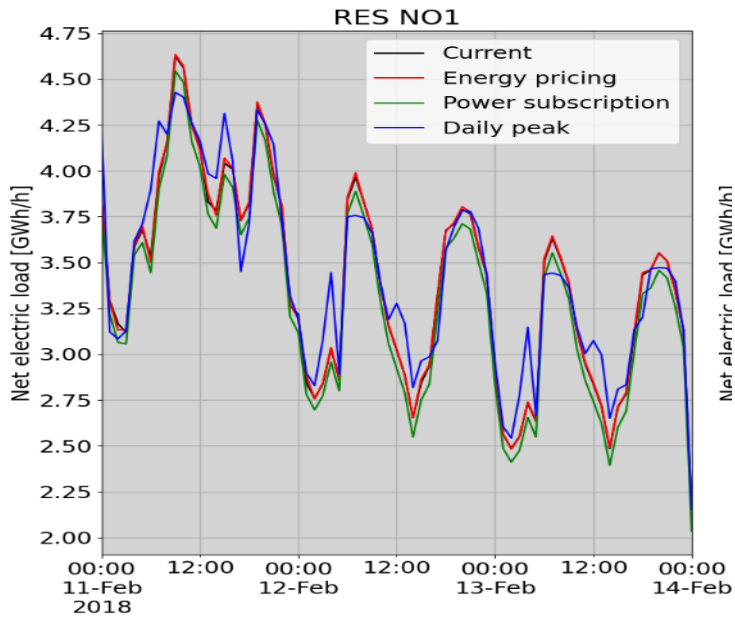

Figure 31: Hourly aggregate *net electric load* for Residential buildings in NO1. Comparison of three different grid tariffs.

4.7 Further work

Further improvement of technologies:

- Restrictions of ASHP of ambient temperatures below $-15\text{ }^{\circ}\text{C}$, and delta T above $60\text{ }^{\circ}\text{C}$.
- Restrictions of GSHP with delta-T above $60\text{ }^{\circ}\text{C}$.
- Improved modelling of COP of A2A heat pumps.
- Inclusion of bio-gas fired micro-CHP is of priority for further work.

Implementation of dynamics in the thermal mass of the building envelope and the hot water tank:

- Thermal mass (2R2C): Implement thermal mass as a thermal circuit. Can possibly set up directly as (in this case) two equations in Pyomo.
- Hot water tank (1R1C): To introduce dynamics in the hot water storage technologies, these can be modeled as thermal circuits as well.

Python challenges:

- Optimization of clusters
- Further work on result handling with stochastic optimization
- Need to investigate further whether any problems arise with the spawning of child-processes etc.

4.8 References

- Andersen, I. M. (2018). *Stochastic Optimization of Zero Emission Buildings*. Norwegian University of Science and Technology.
- Bagle, M., & Lindberg, K. B. (2019). *Investigation into the impact of thermal energy flexibility on cost optimal design and operation of Zero Emission Buildings*. NTNU.
- Bjelland Eriksen, A. et. al. (2020). *Endringer i nettleiestrukturen*. Retrieved from http://publikasjoner.nve.no/rme_hoeringsdokument/2020/rme_hoeringsdokument2020_01.pdf
- Bøhn, T. I., Palm, L. T., Bakken, L., Nossun, Å., & Jordell, H. (2012). Potensial- og barrierestudie: Energieffektivisering i norske yrkesbygg. Bakgrunnsrapport. *Enova Report 2012-01.2*.
- Dorfner, J. (n.d.). urbs: A linear optimisation model for distributed energy systems — urbs 1.0.0 documentation. Retrieved March 18, 2020, from <https://urbs.readthedocs.io/en/latest/>
- Drammen Fjernvarme AS. (2020). Produksjonsanlegg. Retrieved May 5, 2020, from <https://df.no/om->

- oss/produksjonsanlegg
- Fortum Varme. (2020). Fjernvarmenettet i Oslo. Retrieved May 5, 2020, from <https://www.fortum.no/bedrift-og-borettslag/fjernvarme/om-fjernvarme/fjernvarmenettet-i-oslo>
- Kaut, M., Midthun, K. T., Werner, A. S., Tomasgard, A., Hellemo, L., & Fodstad, M. (2014). Multi-horizon stochastic programming. *Computation Management Science*, *11*, 179–193. <https://doi.org/10.1007/s10287-013-0182-6>
- Korpås, M. (2004). *Distributed Energy Systems with Wind Power and Energy Storage*.
- Lien, S. K., Langseth, B., Spilde, D., & Lindberg, K. B. (2018). *LEAP-NORGE 2016*.
- Lindberg, K. B. (2017). *Impact of Zero Energy Buildings on the Power System: A study of load profiles, flexibility and system investments* (Norwegian University of Science and Technology). Retrieved from <https://ntnuopen.ntnu.no/ntnu-xmlui/handle/11250/2450566>
- Lindberg, K. B., Bakker, S. J., & Sartori, I. (2019). Modelling electric and heat load profiles of non-residential buildings for use in long-term aggregate load forecasts. *Utilities Policy*, *58*, 63–88. <https://doi.org/10.1016/j.jup.2019.03.004>
- Lindberg, K. B., Fischer, D., Doorman, G. L., Korpås, M., & Sartori, I. (2016). Cost-optimal energy system design in Zero Energy Buildings with resulting grid impact: A case study of a German multi-family house. *Energy and Buildings*, *127*, 830–845.
- Mitsubishi ZUBA Cold Climate Air Source Heat PumpsEncore Geothermal. (n.d.). Retrieved March 18, 2020, from <https://web.archive.org/web/20141021195035/http://encore-geothermal.ca/sustainable-solutions/air-source-heat-pumps/>
- Mjønes, C., Pettersen, F. V. H., Kristoffersen, B. S., Birkeland, B. M., Essen, J. von, Haaberg, K. J., & Myhre, L. (2012). Potensial- og barrierestudien. Boliger. *Enova Report 2012-01.1*.
- Nett, H. (n.d.). Nettleiepriser og tariffør - privat- og næringskunder - Haugaland Nett. Retrieved February 14, 2020, from <https://haugaland-nett.no/kunde/nettleie/nettleiepriser-tariff/>
- Norgesnett. (n.d.). Nettleie - Norgesnett. Retrieved February 14, 2020, from <https://norgesnett.no/nettleie/#/effektbasert-nettleie/>
- Oslofjord Varme AS. (2020). Produksjonsanlegg Sandvika. Retrieved May 5, 2020, from <https://www.oslofjordvarme.no/anlegg/sandvika/>
- Pedersen, L., Stang, J., & Ulseth, R. (2008). Load prediction method for heat and electricity demand in buildings for the purpose of planning for mixed energy distribution systems. *Energy and Buildings*, *40*(7), 1124–1134. <https://doi.org/10.1016/j.enbuild.2007.10.014>
- Rocha, P., Kaut, M., & Siddiqui, A. S. (2016). Energy-efficient building retrofits : An assessment of regulatory proposals under uncertainty. *Energy*, *101*, 278–287. <https://doi.org/10.1016/j.energy.2016.01.037>
- Sandberg, N. H., Sartori, I., Vestrum, M. I., & Brattebø, H. (2017). Using a segmented dynamic dwelling stock model for scenario analysis of future energy demand: The dwelling stock of Norway 2016–2050. *Energy and Buildings*, *146*, 220–232. <https://doi.org/10.1016/j.enbuild.2017.04.016>
- Seljom, P., & Tomasgard, A. (2015). Short-term uncertainty in long-term energy system models - A case study of wind power in Denmark. *Energy Economics*, *49*, 157–167. <https://doi.org/10.1016/j.eneco.2015.02.004>
- Skar, C., Doorman, G., & Tomasgard, A. (2014). The future European power system under a climate policy regime. *ENERGYCON 2014 - IEEE International Energy Conference*, 318–325. <https://doi.org/10.1109/ENERGYCON.2014.6850446>
- SN/TS 3031:2016. (n.d.). Retrieved March 18, 2020, from <https://www.standard.no/no/Nettbutikk/produktkatalogen/Produktpresentasjon/?ProductID=859500>
- Spilde, D., & Skotland, C. (2016). *Hva betyr elbiler for strømmettet ?*
- Staffell, I., Brett, D., Brandon, N., & Hawkes, A. (2012, November). A review of domestic heat pumps. *Energy and Environmental Science*, Vol. 5, pp. 9291–9306. <https://doi.org/10.1039/c2ee22653g>
- Statkraft. (2020a). Varmeproduksjon Ås 2019. Retrieved May 5, 2020, from <https://www.statkraftvarme.no/om-statkraftvarme/vare-anlegg/norge/Aas/>
- Statkraft. (2020b). Varmeproduksjon Gardermoen 2019. Retrieved May 5, 2020, from <https://www.statkraftvarme.no/om-statkraftvarme/vare-anlegg/norge/gardermoen/>
- Statkraft. (2020c). Varmeproduksjon Moss 2019. Retrieved May 5, 2020, from <https://www.statkraftvarme.no/om-statkraftvarme/vare-anlegg/norge/Moss/>

Statkraft. (2020d). Varmeproduksjon Sandefjord 2019. Retrieved May 5, 2020, from <https://www.statkraftvarme.no/om-statkraftvarme/vare-anlegg/norge/sandefjord/>

5 Energy system Norway – TIMES-Norway

Pernille M.S. Seljom, Lisa Kvalbein, Eva Rosenberg (IFE)

5.1 TIMES-Norway model description

TIMES-Norway is an optimization model of the Norwegian energy system that is generated by TIMES (The Integrated MARKAL-EFOM System) modeling framework. TIMES is a bottom-up framework that provides a detailed techno-economic description of resources, energy carriers, conversion technologies, and energy demand. TIMES models minimize the total discounted cost of a given energy system to meet the demand for energy services for the regions over the period analyzed. The total energy system cost includes investment costs in both supply and demand technologies, operation and maintenance costs, and income from electricity export to and costs of electricity import from countries outside Norway.

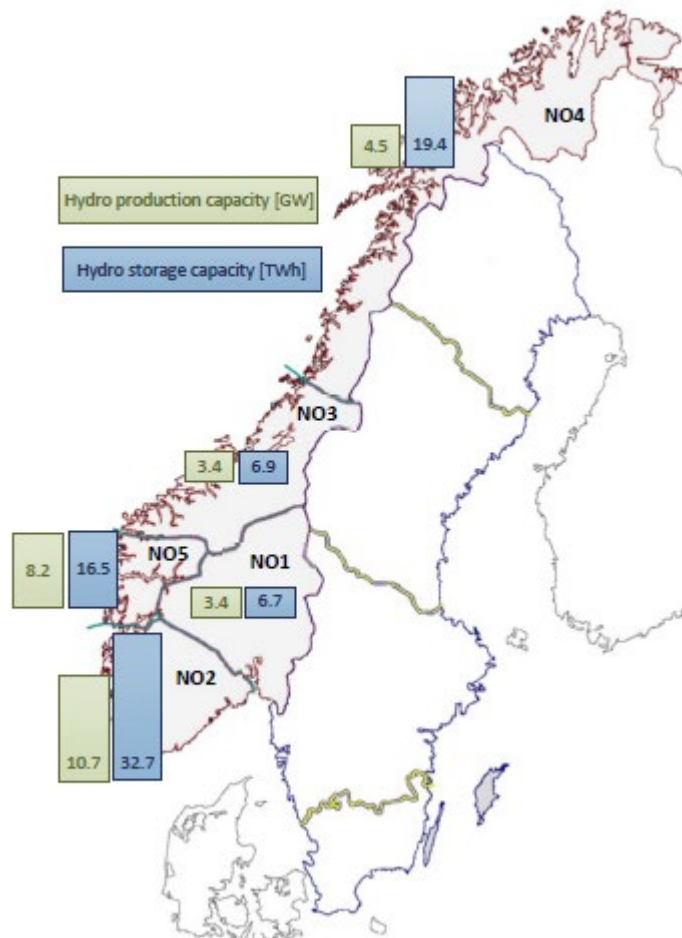

Figure 32: Map of Norway, divided by price area, indicating hydro generation and storage capacity.

TIMES-Norway is a technology-rich model of the Norwegian onshore energy system divided into five regions corresponding to the current electricity market spot price areas. An illustration of the price areas, with corresponding hydropower generation and reservoir capacity, are illustrated in Figure 32. The model provides operational and investment decisions from the starting year, 2018, towards 2050, with model periods for every fifth year from 2020 within this model horizon. To capture operational variations in energy generation and end-use, each model period is divided into 96 sub-annual time slices, where four seasons are represented by 24 chronological hours. The model has a detailed description of the end-use of energy, and the demand for energy services is divided into numerous end-use categories within industry, buildings, and transport. Note that energy services refer to the services provided by consuming fuel and not the fuel consumption itself. For example, the heating demand in buildings is an energy service, while the fuel used to heat the building is not. Each energy service demand category

can be met by existing and new technologies using different energy carriers such as electricity, bioenergy, district heating, hydrogen, and fossil fuels. Other input data include fuel prices; electricity prices in countries with transmission capacity to Norway; renewable resources; and technical characteristics such as costs, efficiencies, and lifetime and learning curves.

5.1.1 Building sector

The building sector of TIMES-Norway is divided into residential and non-residential/commercial buildings for each of the model regions. The buildings are further split into existing and new buildings in each region where existing buildings have a stock of equipment, including heating technologies, in the start year. The residential end-use demand is split in central heating, point-source heating, hot water, and electricity specific demand. For the commercial buildings, end-use demand is divided into central heating, point-source heating, cooling, and electricity specific demand. The electric specific demand includes electricity that is non-substitutable with other energy carriers, such as electricity for lighting and equipment.

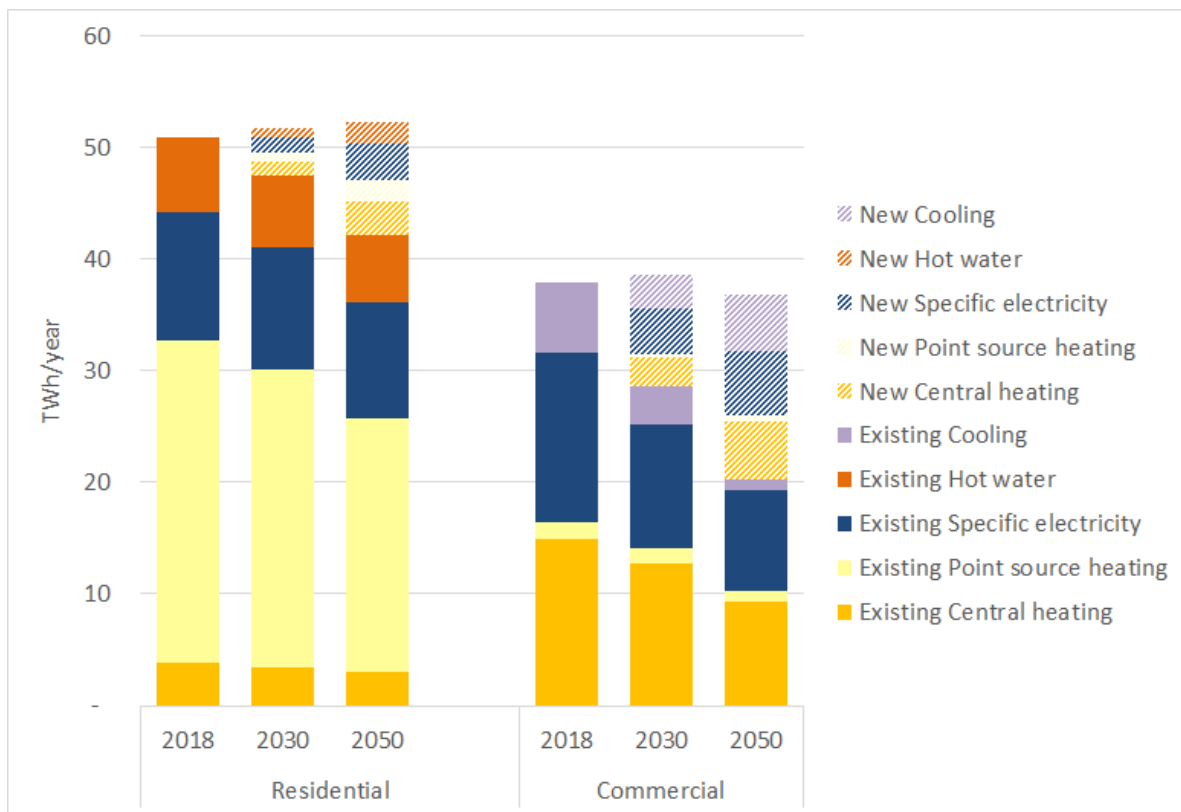

Figure 33: Energy service demand for residential buildings and commercial buildings for the reference case in 2018-2050, TWh/year.

The load profiles, the sub-annual hourly load variations, are based on input from SINTEF Community. In the presented analysis, we assume that the load profiles are the same for all years and for existing and new buildings. The heating profiles differ between regions and for central heating/ point source heating. The profile for non-substitutional electricity is the same for all residential buildings and all non-residential buildings. Examples of load profiles in region NO1 is presented in the figures below.

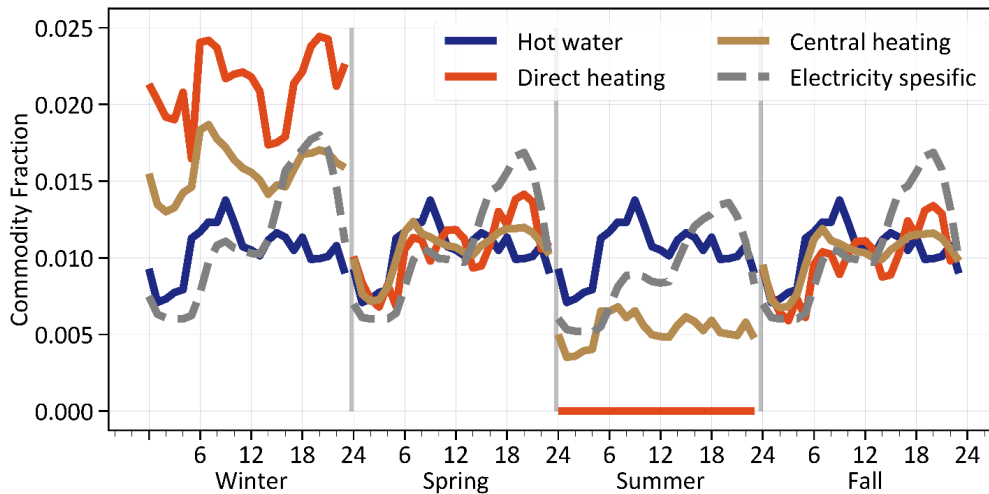

Figure 34: Load profile for residential buildings in model region NO1.

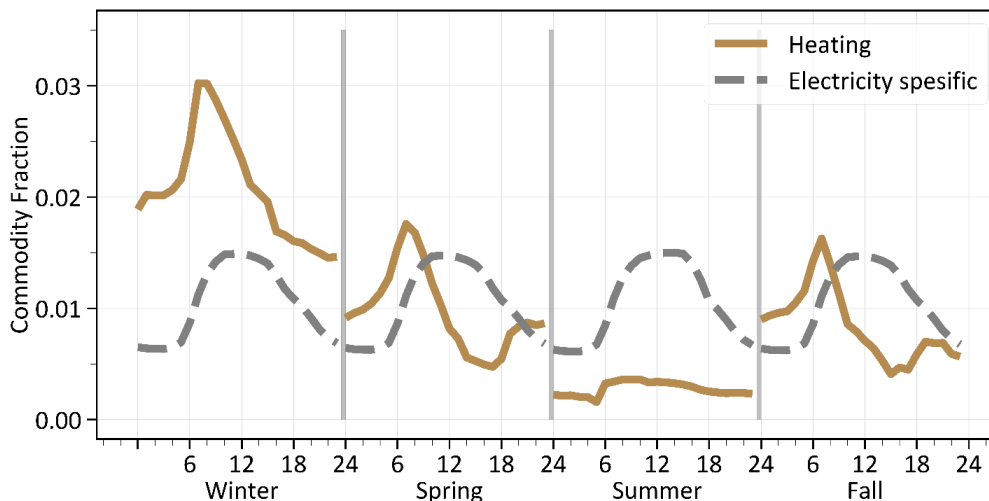

Figure 35: Load profile for commercial buildings in the model region NO1.

The investment and operational cost, annual full load hours, efficiencies, lifetimes, and technology learning rates of technologies in buildings are based on “NVEs kostnadsrapport 2017”. Equipment in the residential sector includes VAT 25%. Further technical assumptions of the building technologies are further specified in Appendix A. The demand projections in residential and non-residential buildings is based on data from previous work in CenSES that is based on the population projection from SSB in 2016. The demand in households is based on population in each area in the projections up to 2040, and after 2040 the share of each region is kept constant.

5.2 Storyline assumptions for TIMES-Norway

This section describes the assumptions, that are in line with the long-term storylines, for the Norwegian energy system, model TIMES-Norway. Note that all four storylines assume that the Norwegian energy system is gradually decarbonized within 2050 and that Norway has no or a limited net import of biomass products.

For the project deliverable of 2020, we limit the TIMES analysis to the three first storylines and exclude analysis of the *Climate Panic nation* storyline. This is because we prioritize to focus on the storylines that are straight forward to implement to the model. Nevertheless, we have still started to work on the climate panic storyline since it builds on the *Oil nation* storyline.

Table 7 summarises the TIMES model assumptions for the *Oil, Energy, and Nature nation* storyline. The listed TIMES model assumptions will be elaborated further in the sections below. Note that the storyline assumptions are model input and not model results.

Table 7: TIMES-Norway model assumption for the Oil, Energy and Nature nation storyline.

Model assumption	Oil nation	Energy nation	Nature nation
Carbon capture & storage	From 2030	No	No
Blue hydrogen production	From 2030	No	No
Technology learning: Green hydrogen	Low	High	Moderate
Technology learning: PV and stationary batteries	Low	High	Moderate
Cost building-integrated PV	High	Moderate	Low
New wind power potential	Moderate	High	No new capacity
Technology learning: Wind power	Moderate	High	Low
National transmission grid expansion	If profitable	If profitable	No
International electricity grid expansion	No	If profitable	If profitable
Energy efficiency in buildings*	No	If profitable	Yes
Settlement pattern	Status quo	Status quo	More urbanization and smaller areas
Road Transport demand projections	High	Moderate	Low
Industry activity projections	Basis prognosis	Basis prognosis without oil and gas	Status quo without oil and gas

* Note that we define energy efficiency to be a measure that reduces the energy service demand. The energy service demand is not energy consumption, but the services a given energy consumption provides, such as heating and transport demand. Consequently, by this definition, a technology switch from, e.g., an electric boiler to a heat pump, is not in this context an energy efficiency measure. Furthermore, in TIMES-Norway the technology choice is a model result and not a model assumption.

5.2.1 Technology learning: Green hydrogen

Small-scale hydrogen generation from electrolysis is included as an investment option in TIMES-Norway. The technology learning on investment costs and efficiency varies for the three storylines, as indicated in Table 8. The investment costs are interpolated between the specified model periods. Note that the investment cost for the PEM electrolysis includes a storage tank and that the efficiency corresponds to the hydrogen output, in kWh, over the required electricity use, in kWh.

Large-scale hydrogen generation, with the transport of hydrogen between Norwegian spot price regions, is considered a part of further work.

Table 8: Technology learning assumptions for green hydrogen production for the Oil, Energy, and Nature nation storyline.

Investment cost, NOK/kW	Storyline	2020	2025	2030	2050
Electrolysis, Alkaline	Oil	17,600	14,514	14,514	14,514
	Energy	17,600	14,514	12,800	9,309
	Nature	17,600	14,514	12,800	12,800
Electrolysis, PEM	Oil	25,520	19,760	19,760	19,760
	Energy	25,520	19,760	16,560	10,746
	Nature	25,520	19,760	16,560	16,560
Efficiency, H2/ ELC (kWh)	Storyline	2020	2025	2030	2050
Electrolysis, Alkaline	Oil	0.62	0.65	0.65	0.65
	Energy	0.62	0.65	0.67	0.72
	Nature	0.62	0.65	0.67	0.67
Electrolysis, PEM	Oil	0.58	0.66	0.66	0.66
	Energy	0.58	0.66	0.71	0.86
	Nature	0.58	0.66	0.71	0.71

5.2.2 Technology learning: Solar power and stationary batteries

The investment costs in residential and commercial solar power differ between the storylines, as indicated in Table 9. Note that the investment costs are interpolated between the specified model periods.

Stationary batteries are not included in the used model version. We consider including investment options in stationary batteries, with storyline dependent learning curves, as a part of further work.

Table 9: Technology learning assumptions PV for the Oil, Energy, and Nature nation storyline.

Investment cost, NOK/kW	Storyline	2020	2025	2030	2050
Residential solar power	Oil	14,000	12,800	12,800	12,800
	Energy	14,000	12,800	10,500	8,000
	Nature	14,000	12,800	10,500	10,500
Commercial solar power	Oil	10,000	9,000	9,000	9,000
	Energy	10,000	9,000	7,000	5,000
	Nature	10,000	9,000	7,000	7,000

5.2.3 Cost for building-integrated solar power

The additional cost of building-integrated PV (BiPV), compared to building materials, is assumed to differ between the various storylines. Estimating the additional costs of BiPV, with a corresponding upper potential by spot price region, is a part of further work.

5.2.4 Wind power potential

The wind power potential reflects the upper limit for wind power capacity in Norway. For *Nature Nation*, we assume that only approved wind power investments will be executed. For the *Oil Nation*, the upper limit for wind power investments is 26 TWh, whereas, for the *Energy Nation*, we assume the potential is 48 TWh, as shown by the spot price region in Table 10. Note that the indicated wind power potential also includes existing wind power. Consequently, the potential for new investments is 11 TWh and 33 TWh for the *Oil Nation* and *Energy Nation*, respectively. Nevertheless, the model only invests

in new wind power if it is profitable from a Norwegian energy system perspective in the *Oil* and *Energy nation*.

Table 10: Wind power potential for the Oil, Energy, and Nature nation storyline.

Wind potential, TWh	Storyline	NO1	NO2	NO3	NO4	NO5	Total
	Oil	1.1	7.0	9.7	7.9	0.2	26
	Energy	1.7	11.7	15.0	19.1	0.5	48
	Nature	0.8	4.7	7.1	2.4	0.1	15

5.2.5 Technology learning: Wind power

For the *Oil nation*, we assume that the investment costs range from 17 700 to 10 600 NOK/kW in 2020 and from 13,400 to 4,000 NOK/kW in 2035. For the *Energy nation*, we assume that the technology learning on wind power higher than the *Oil nation* where the investment costs in the new wind power range from 12,060 to 3,600 NOK/kW in 2035. Note that the investment costs are interpolated between the specified model periods and extrapolated from 2035. For all storylines, the annual capacity factor, representing operating hours, from 0.28 to 0.43, depending on location.

5.2.6 Transmission grid expansion

The possibilities to invest and expand national transmission capacities between the regions are set to be done only if it is profitable for Norway in the *Oil Nation* and the *Energy nation*. The assumed investment costs and the assumed existing capacity between the Norwegian spot price regions are shown in Table 11. For the *Nature nation*, we do not allow for any further expansion of the national transmission grid. For *Oil Nation* and the *Energy nation*, we set a maximum new capacity expansion of the national transmission to equal the existing transmission capacity as between the model regions, as shown in Table 11.

Table 11: Investment cost for new national transmission capacity and existing national transmission capacity in 2020.

Investment cost, NOK/kW	NO1	NO2	NO3	NO4	NO5
NO1		841	2,049		1,216
NO2	841				1,265
NO3	2,049			3,807	1,195
NO4			3,807		
NO5	1,216	1,265	1,195		
Transmission capacity, MW	NO1	NO2	NO3	NO4	NO5
2020	NO1	3,500	500		3,900
	NO2	3,500			600
	NO3	500		1,200	500
	NO4		1,200		
	NO5	3,900	600	500	

Table 12: Investment cost for new international transmission capacity and existing international transmission capacity in 2020.

Investment cost, NOK/kW	NO1	NO2	NO3	NO4	NO5
SE3	1,264				
DK1		5,714			
DE		8,750			
NL		8,570			
UK		14,285			14,285
Transmission capacity, MW	NO1	NO2	NO3	NO4	NO5
2020	SE1			700	
	SE2		1,000	300	
	SE3	2,145			
	DK1	1,632			
	RUS				56
	DE	1,400			
	NL	723			
	UK	1400			

Grid expansion to countries outside Norway is not allowed for *Oil Nation* as it is in line with current trends. For *Energy Nation* and *Nature Nation*, grid expansion is done if it is profitable for Norway. The assumed investment cost of new capacity is shown in Table 11, where the investment cost varies due to the distance and technologies (cable vs. lines). Table 11 also shows the current international trade capacity that is the same for all storylines. New international transmission capacity to European countries is limited to 1,400 MW.

5.2.7 Settlement patterns and energy efficiency in buildings

The demand for energy services in residential and non-residential buildings is different in the three storylines, as shown in Figure 36.

In the *Oil nation*, the demand grows due to increased population, without any changes in current settlement patterns and emphasis on energy efficiency, but with a natural improvement due to stronger building regulations and demolition and renovation of existing buildings. The total energy service demand towards 2050 remains constant at the level of today, about 89 TWh per year.

As opposed to the *Oil nation*, energy efficiency measures will be invested in *Energy nation* if it is profitable. The total potential for energy efficiency in buildings is about 19 TWh in 2050. Besides the implementation of energy efficiency is the demand for energy services the same as in *Oil Nation*.

Nature nation has a strong focus on energy efficiency and urban living, with more apartments, less single-family houses, and decreased living areas. This implies that all possible energy efficiency measures are implemented, and the area of new dwellings is reduced by 20%. The share of single-family houses of new residential buildings is reduced from 60% to 25%. These measures result in that the total energy service demand is reduced by 26 TWh or 29% compared to 2018 for *Nature nation*.

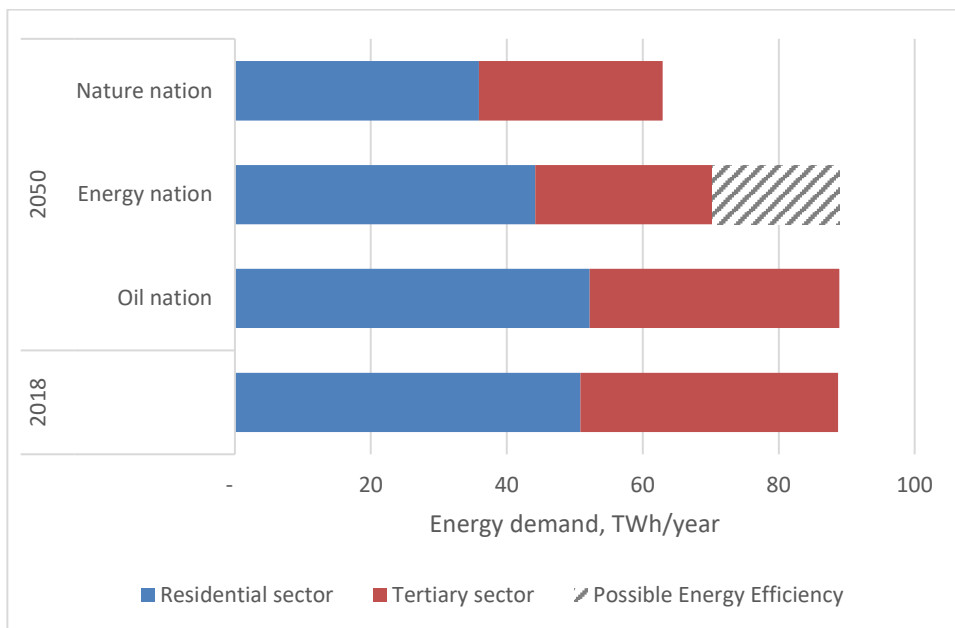

Figure 36: Energy service demand for buildings in 2018 and in 2050 in the three storylines, TWh/year.

5.2.8 Transport demand projection

The demand for energy services in the transport sector differs for the three storylines, as shown in Figure 38. We assume that the *Oil nation* has the highest transport energy service demand in transport, and we assume this projection corresponds to “Nasjonal Transportplan”. Further, we assume the demand projections are of *Energy nation* is lower than the *Oil nation* where the projections are according to “Nasjonalbudsjett 2019”. Finally, we assume that the transport demand in *Nature nation* is the lowest among the storylines where the projections are inspired by “Klimakur 2030”.

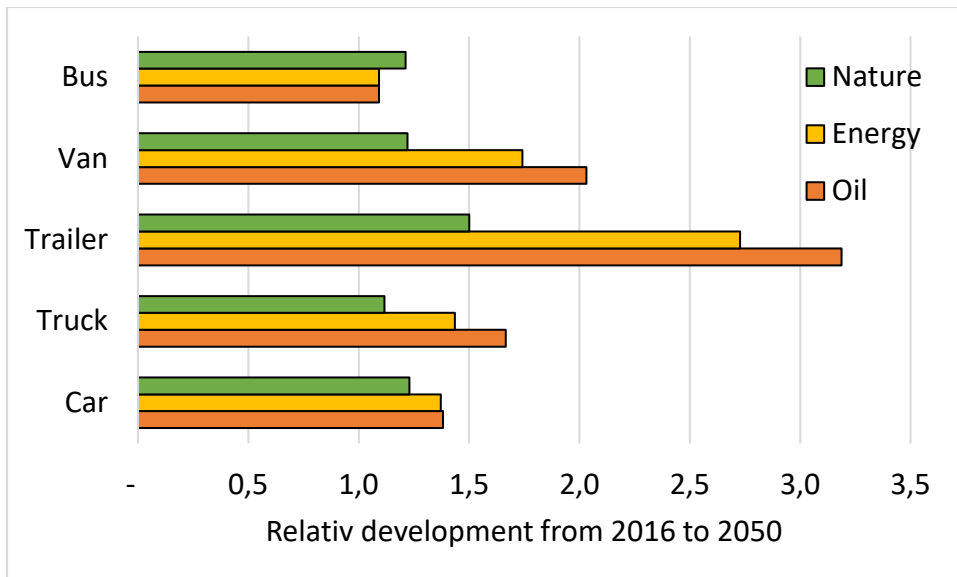

Figure 377: Relative development of energy service demand for road transport in 2050 compared to 2016 for the three storylines.

5.2.9 Industry demand projections

The specific electricity demand of the Norwegian industry differs between the three storylines, as shown in Figure 38.

The demand projection of the *Oil Nation* is mainly based on known and planned changes in the industry. Expectations of electricity use for data centers and electrification of offshore oil and gas installations are included.

In the *Energy nation*, the demand is lower than *Oil Nation* since it is assumed that the oil and gas production is phased out. As a result of this, the electricity used for offshore installations is assumed linearly phased out from 2030 to 2050, and the oil refineries are closed.

The *Nature nation* assumes a constant demand from 2020 to 2050 and a linearly phase-out of electricity for offshore activities from 2030 to 2050. This implies that we assume that the industrial activity is like the current activity in 2050 except the oil and gas sector that is phased out.

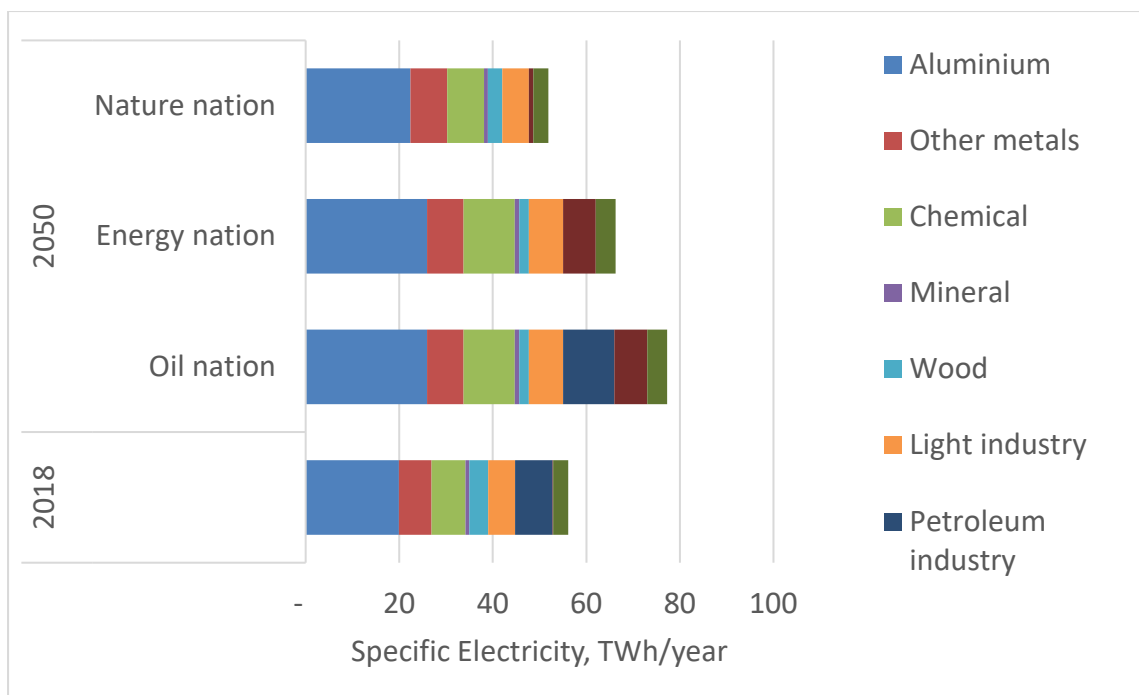

Figure 38: Demand of specific electricity in 2018 and in 2050 for the three scenarios, TWh/year

5.2.10 European electricity prices

TIMES-Norway uses electricity prices for countries with transmission capacity to Norway from EMPIRE. We assume that the European electricity sector is decarbonized towards 2050, and the difference between the storylines is whether Carbon Capture and Storage (CCS) is a commercially available technology or not. For the *Oil nation*, we assume that CCS is commercially available in the electricity generation technology in Europe, whereas in *Energy nation* and *Nature nation*, we assume that CCS is not available as a commercial option in Europe towards 2050.

To exemplify the model input on European electricity prices, we show the expected electricity prices in 2030 and 2050 for Germany for the *Oil nation*, with CCS, Figure 39. The corresponding prices for *Energy Nation* and *Nature Nation*, when CCS is not available, is shown in Figure 40.

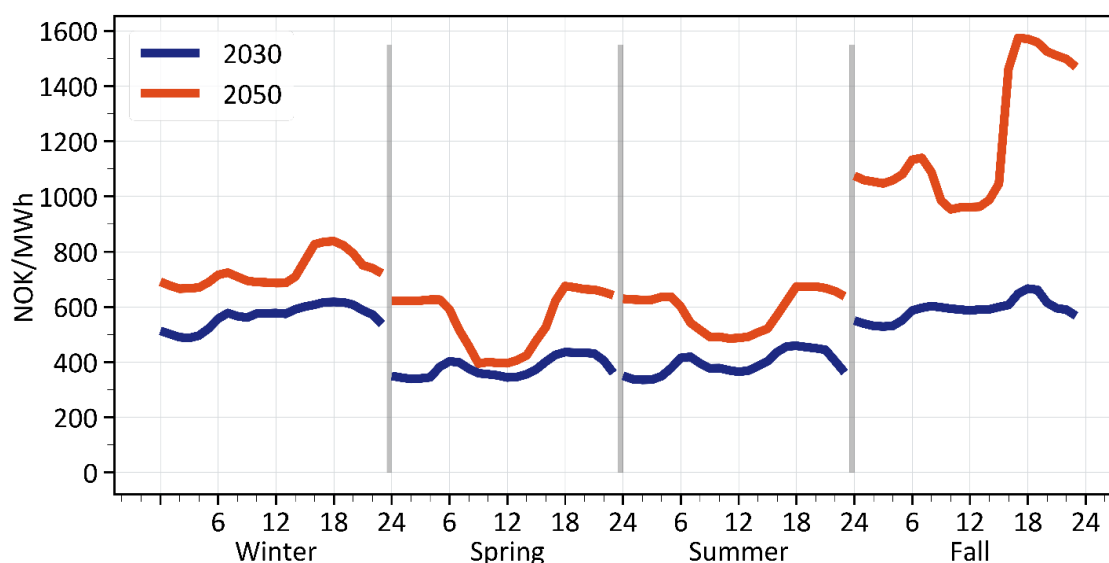

Figure 39: Electricity prices for Germany for Oil nation in 2030 and 2050 with CCS in Europe.

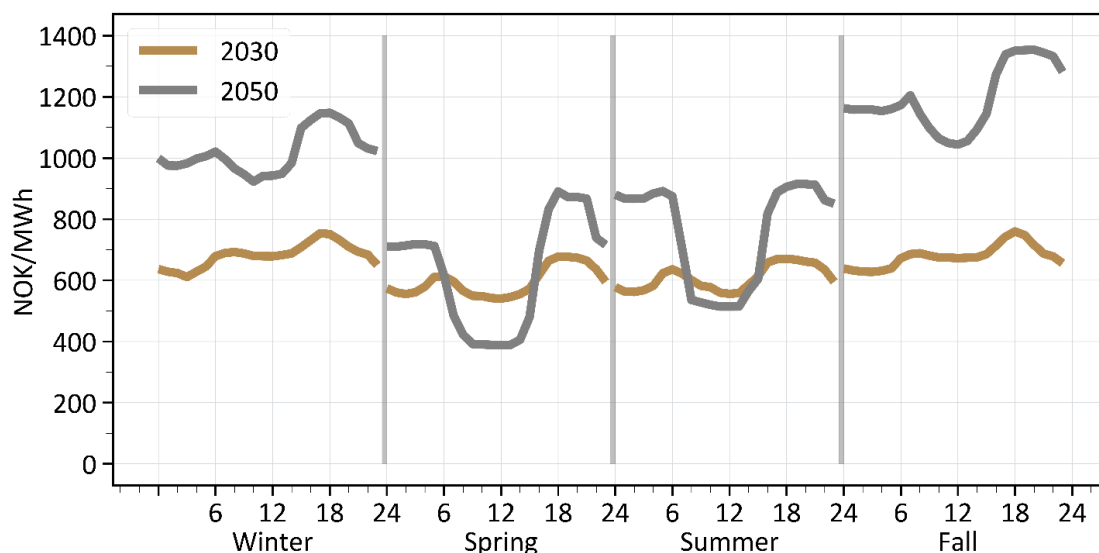

Figure 40: Electricity prices for Germany for Energy nation and Nature nation without CCS in Europe.

5.3 Model results

This section presents TIMES model results for the three storylines: *Oil nation*, *Energy nation*, and *Nature nation* with a focus on the electricity and building sector.

5.3.1 Electricity balance

Both the electricity generation, electricity consumption, and electricity trade differ for the three storylines. The Norwegian electricity balance for 2020, 230, 2040, and 2050 for the analyzed storylines are demonstrated in Table 13. Note that the presented results are just a selection of the model results since TIMES-Norway provides model decisions for each fifth year from 2020 to 2060. Further note that electricity supply, generation, and import, is indicated with positive numbers and electricity demand, electricity consumption, loss, and electricity export, is indicated with negative numbers. Also, note that the loss includes both high and low voltage losses.

Table 13: Norwegian electricity balance from 2020 to 2050 for Oil, Energy, and Nature nation.

Results	Storyline	2020	2030	2040	2050
Generation (TWh)	Oil	149	178	184	190
	Energy	149	178	201	208
	Nature	149	172	180	169
Consumption (TWh)	Oil	-131	-157	-169	-174
	Energy	-132	-145	-166	-170
	Nature	-133	-140	-140	-148
Net import (TWh)	Oil	-6	-7	0	-1
	Energy	-4	-19	-19	-24
	Nature	-4	-19	-27	-7
Loss (TWh)	Oil	-12	-15	-15	-15
	Energy	-12	-14	-15	-14
	Nature	-12	-13	-13	-14

Table 13 shows that the electricity generation from 2030 is the highest for *Energy nation* and lowest for *Nature nation*. The corresponding electricity generation, split by technology and storyline, is illustrated in Table 14. The table shows that it is primarily the wind power and solar power, PV, that differs

between the storylines. Note that there is also some electricity generation from Combined Heat and Power (CHP) plants, but this generation is marginal on the presented scale.

A first observation is that PV is a cost-competitive technology for all three storylines, both located at residential and commercial buildings. The PV generation is highest for the *Energy nation*, followed by the *Nature nation* and *Oil nation*. Besides technology costs, the PV investments depend on the correlation between the solar generation and the hourly consumption profile in residential and commercial buildings, as well as the taxes and distribution grid fee of electricity. There is an advantage for local PV generation in residential buildings since the electricity supplied from the electricity grid is exposed to VAT, although the investment costs are higher in the residential sector due to small scale installations.

A second observation is that wind power generation is significantly higher for *Energy nation* than the *Oil nation* from 2040. Besides technology costs and wind conditions, the wind power investments depend on the development of the European power market, the national and international trading capacity, and the correlation with demand and other types of electricity generation.

Table 14: Norwegian electricity generation, by technology, from 2020 to 2050 for Oil, Energy and Nature nation

Results	Storyline	2020	2030	2040	2050
Hydropower (TWh)	Oil	135	156	157	157
	Energy	135	156	156	156
	Nature	135	157	157	157
Wind (TWh)	Oil	14	22	25	25
	Energy	14	21	36	37
	Nature	14	15	13	0
PV Residential (TWh)	Oil	0	0	3	4
	Energy	0	1	5	9
	Nature	0	0	6	7
PV Commercial (TWh)	Oil	0	0	0	3
	Energy	0	0	3	6
	Nature	0	0	4	5
Total (TWh)	Oil	149	178	184	190
	Energy	149	178	201	208
	Nature	149	172	180	169

We observe that the consumption of electricity, which is a model result, differs significantly between the storylines. The electricity consumption depends on, e.g., investments in end-use technologies and the implementation of energy efficiency measures. Table 14 shows that electricity consumption towards 2050 is lowest in *Nature nation* and highest in the *Oil nation*. The split of the electricity consumption by sector is further specified in Table 15. Note that the electricity consumption for hydrogen production for transport purposes is included in *Transport* and for industrial purposes are included in *Industry*. Furthermore, we include all Electric Vehicle (EV) charging in *Transport*, although the charging locating varies between residential buildings, commercial buildings, and fast-charging stations.

For the industry sector, electricity consumption follows the industry demand projections with the largest consumption in the *Oil nation* and smallest in *Nature nation*. Note that *Energy* and *Nature nation*, with no oil and gas activity, consumes electricity for hydrogen production, whereas the industry sector in the *Oil nation* uses hydrogen that is produced from natural gas. Also, the electricity consumption to produce a ton of hydrogen is higher in *Nature* than the *Energy nation* since we assume that technology learning on green hydrogen is higher for *Energy nation*.

For the transport sector, electricity consumption is the lowest in the *Oil nation*. This is despite that the demand for transport services is highest in this storyline as opposed to the other storylines that use

electricity to produce hydrogen by electrolysis. In 2050, the electricity consumption for hydrogen production is 15 TWh and 13 TWh, corresponding to 39% and 37% of the electricity consumption in the Transport sector, for *Energy* and *Nature nation* respectively.

For the residential and commercial sector, the electricity consumption is lowest in *Nature nation* and highest in *Oil nation* among the three storylines. For example, in 2050, the residential electricity consumption is 29%, and commercial consumption is 27% lower in lower in *Nature nation* than *Energy nation*, respectively. These differences in electricity consumption are closely linked to the implementation of energy efficiency measures, where *Nature nation* has the most energy efficiency and a more centralized settlement pattern. The share of electricity used for buildings, residential and commercials, of the total electricity consumption declines from 2020 to 2050. For example, for the *Oil nation*, the building electricity consumption share is 47% in 2020 and 36% in 2050. Also, the generation of green hydrogen and implementation of energy efficiency influences this share, and in 2050 the building electricity consumption share is 31% for the *Energy* and *Nature nation*.

Table 15: Norwegian electricity consumption from 2020 to 2050 for Oil, Energy, and Nature nation split by sector.

Results	Storyline	2020	2030	2040	2050
Industry (TWh)	Oil	-66	-79	-87	-88
	Energy	-66	-76	-81	-78
	Nature	-66	-72	-68	-65
Transport (TWh)	Oil	-2	-11	-16	-20
	Energy	-2	-14	-31	-38
	Nature	-2	-12	-22	-35
District heat (TWh)	Oil	-1	-2	-3	-3
	Energy	-1	-1	-2	-1
	Nature	-1	-2	-2	-2
Residential (TWh)	Oil	-39	-41	-42	-42
	Energy	-39	-35	-35	-35
	Nature	-40	-34	-32	-30
Commercial (TWh)	Oil	-23	-24	-22	-21
	Energy	-25	-18	-17	-17
	Nature	-24	-20	-16	-15
Total (TWh)	Oil	-131	-157	-169	-174
	Energy	-132	-145	-166	-170
	Nature	-133	-140	-140	-148

5.3.2 Transmission Capacity

Energy nation is the only storyline with new investments in national transmission capacity between Norwegian spot price regions. For the *Oil nation*, there is no new national transmission capacity, although it is a modeling option, and there is no new capacity in *Nature nation* since this storyline does not allow for capacity expansion. As seen in Table 16, the *Energy nation* expands the capacity between the model regions that are connected to NO3. By 2040, the transmission capacity between NO1 and NO3 and NO5 and NO3 is doubled to 2,000 MW. Furthermore, the capacity between NO4 and NO3 is increased by 500 MW to 2050, ending in total capacity of 2,900 MW between these two regions. The expansion could be due to the wind power expansion in NO3 and NO4. This is also seen in the electricity prices, see Figure 43, where the electricity price is lower for these two regions during seasons with high wind power generation.

Table 16: Cumulative new national transmission capacity.

New Transmission Capacity, MW	Storyline	2030	2040	2050
-------------------------------	-----------	------	------	------

NO1 – NO3	Energy	0	1,000	1,000
NO4 – NO3	Energy	0	11	498
NO5 – NO3	Energy	0	1,000	1,000

Since the *Oil nation* does not have the option to build new international transmission capacity, there is no new transmission capacity for this storyline. For the two other storylines, *Energy nation*, and *Nature nation*, when international transmission capacity is an option, there are significant new investments. By 2050, the upper capacity limit for the international transmission to Sweden, Denmark, Netherlands, and the United Kingdom are built, as shown in Table 17. These results emphasize the need to link the Norwegian energy system model, TIMES-Norway, to the European power market model, EMPIRE.

Table 17: Cumulative new international transmission capacity.

New Transmission Capacity, MW	Storyline	2030	2040	2050
NO1 – SE3	Energy	700	1,400	1,400
	Nature	700	1,400	1,400
NO2 – DK1	Energy	0	0	1,400
	Nature	0	0	1,400
NO2 – NL	Energy	0	713	1,400
	Nature	0	1,102	1,400
NO2 – UK	Energy	0	0	1,400
	Nature	0	0	1,400
NO5 – UK	Energy	53	1,400	1,400
	Nature	0	1,400	1,400

5.3.3 Electricity Prices

TIMES-Norway optimizes the operation and investments of the Norwegian energy system and thereby provide the long-term marginal electricity costs for each model region, hereby denoted the electricity price. Note that the long-run marginal cost is the lowest cost to produce one new unit if the capacity and electricity demand can be freely set. The electricity price depends on both the model input on European electricity prices (outside Norway) as well as model decisions of TIMES-Norway. An example of the model decisions that affect the Norwegian prices is the investments in new transmission capacity within and outside Norway, power generation in Norway, and end-use electrification.

Figure 41 shows the expected electricity price in the model region of Oslo, NO1, for *Oil*, *Energy*, and *Nature nation* in 2050. The results show that there are some differences in Norwegian electricity among the storylines. For NO1, the electricity prices in *Energy nation* and *Nature nation* are more similar during all seasons, they also have the largest variability during spring and summer, probably caused by more PV generation. Note that a reason for more similar electricity prices between *Energy* and *Nature nation*, compared to *the Oil nation*, can be explained by that these storylines use the same assumptions of the European electricity prices, whereas, *Oil nation*, assumes different electricity prices.

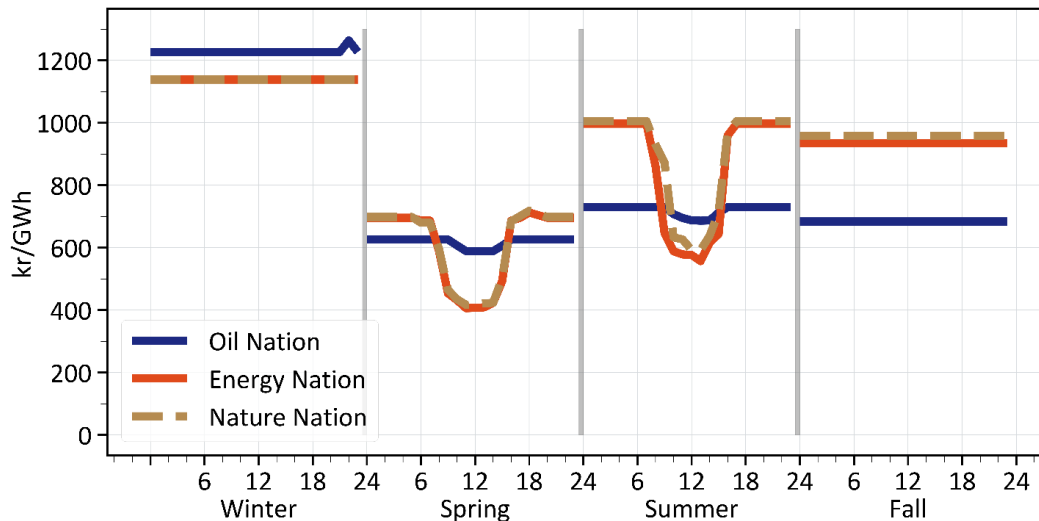

Figure 41: Electricity prices for model region NO1 in 2050 by season for the Oil, Energy and Nature nation storyline.

The results also show that there are regional differences in the electricity price between the model regions. Figure 42 demonstrates the expected electricity price for the *Energy nation* in 2050 for the five model regions. We observe that the price is lowest in NO3 and NO4 in all seasons, except during the middle of the day in summer when there are good solar conditions. A reason for the lower prices in NO3 and NO4 is that there is significant wind power generation in combination with limited transmission capacity. This is supported by the significant transmission capacity expansion to NO3 and NO4, as described in Section 3.2.

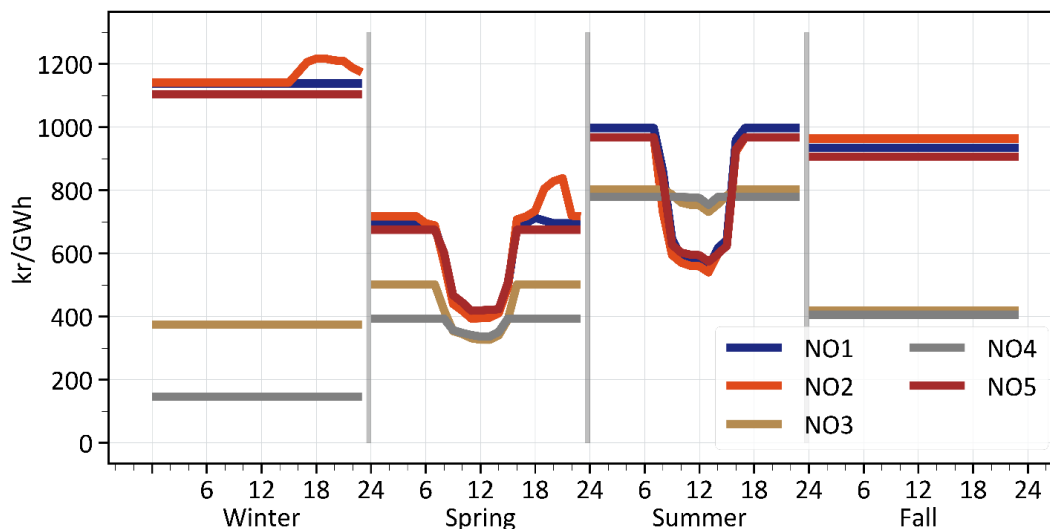

Figure 42: Electricity prices for Energy nation in 2050 for all model regions in Norway.

5.3.4 Residential heating technologies

The heating technologies used between 2020 and 2050 are shown in Figure 43 for the *Oil nation*, *Energy nation*, and *Nature nation*. These results demonstrate that the total heat supply differs between the three storylines. On the other hand, the supply ratio between the heating technology does not significantly vary between the different storylines. As the *Oil nation* only lowers the total heat marginally from 2020, *Nature nation* almost halves the demand from 32 TWh in 2020 to 17 TWh in 2050. This is primarily due to the use of energy efficiency and the lower heat demand projections due to changes in settlement patterns.

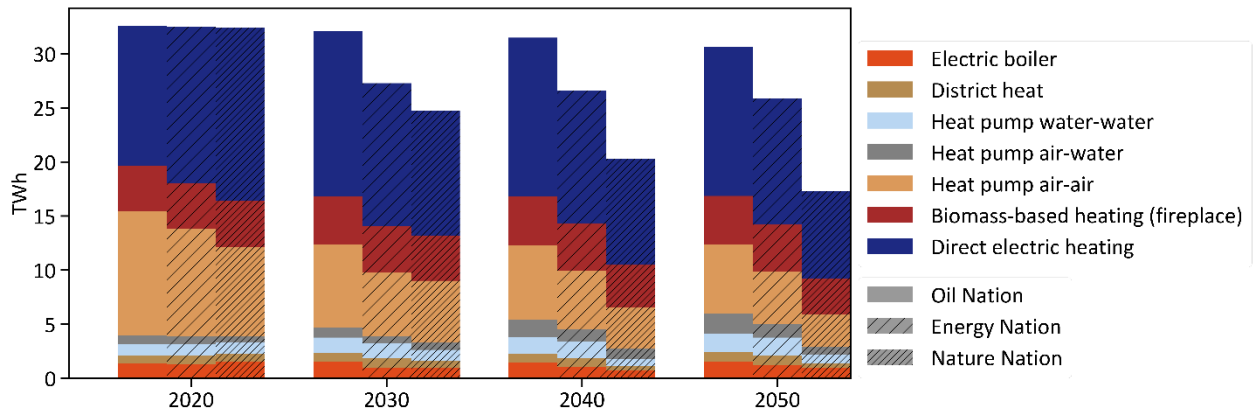

Figure 43: Heat supply to residential buildings by technology, from 2020 to 2050, for Oil, Energy, and Nature Nation.

The hourly supply by technology is shown in Figure 44 for residential buildings with central heating (top) and point source heating (bottom) for NO1 in *Energy Nation* in 2050. For buildings with central heat, hot water demand is served by the same technology as the heat, and the illustration consequently also shows the supply for hot water. For residential buildings with point-sources, hot water demand is served by an electric hot water tank. The heat supply for hot water is, therefore, not shown in the figure, and so no heat demand during the summer. In residential buildings with point sourced heat, wood is used in fireplaces. As a first model assumption, we assume wood-based heating by the fireplace is only allowed between 17 and 22. Due to the relatively low cost of wood, the model chooses not to use any direct electric heating those hours. An adjustment of restrictions related to use of wood-use for heating is needed to be as part of further work.

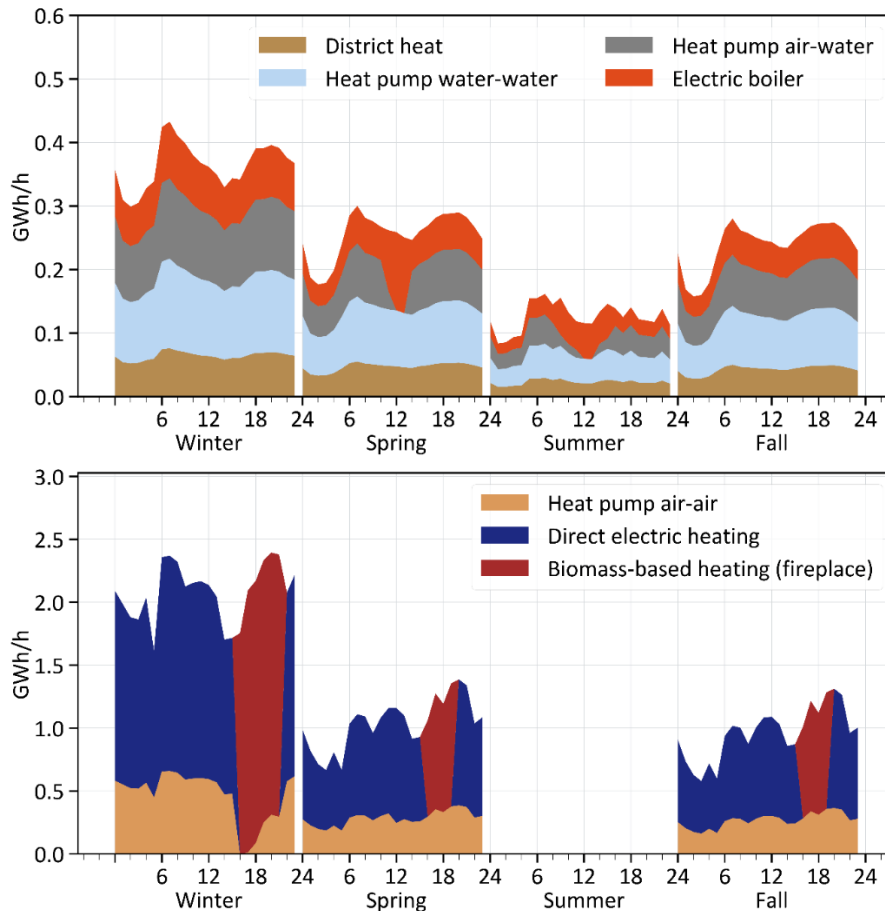

Figure 44: Technologies used for heating in residential buildings in NO1 2050 in Energy nation with central heating (top) and point source heating (bottom).

5.3.5 Commercial heating technologies

The heating technologies used in commercial buildings between 2020 and 2050 are shown in Figure 45 for the *Oil nation*, *Energy nation* and *Nature nation*. As for residential buildings, the heat supply to commercial buildings only lowers marginally for *Oil Nation* in 2050 from 2020. For the other storylines, the reduction in supply is mostly due to energy efficiency. The technology used is changing during the years for all storyline, electric boiler and air-water heat pump are almost phased out. The district heat use is larger technology in *Nature nation* than in *Energy nation* for all years. A reason for this can be due to the different settlement patterns in *Nature nation*.

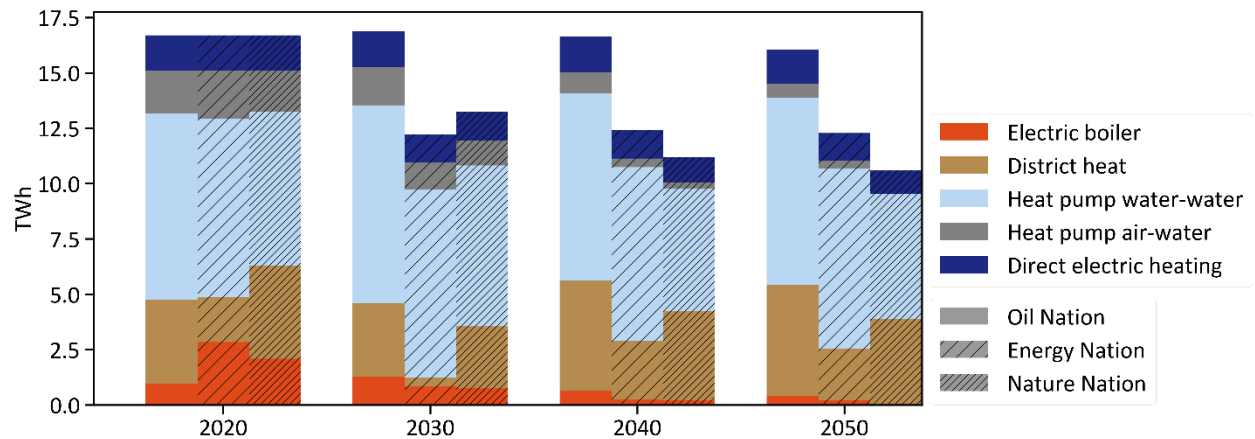

Figure 45: Heat supply to commercial buildings by technology, from 2020 to 2050, for Oil, Energy, and Nature Nation.

5.3.6 Buildings electricity balance

Figure 46 demonstrates the supply and demand of residential buildings in 2050 (incapacity) for the three storylines for NO1. The results demonstrate that the peak electricity demand of the residential sector depends on both the storyline, how EVs are charged, and technology used for heat. As pointed earlier, the fireplace is the main heating technology in the afternoon for residential buildings. As previously mentioned, as a model weakness that needs to be improved, there is a sudden increase in electricity use after 22 o'clock, when the heat supply by wood is restricted. Due to this assumption, there is a peak for electricity use before midnight.

The results also show that the local PV generation will not impact the peak electricity demand alone, as the peak occurs when there is no PV generation. The corresponding peak electricity demand for all storylines and regions is shown in Table 18. The peak happens in the winter during hour 23. Note that no end-use demand flexibility is included in the first analysis, and these results can be considered as the realizations of future storylines within end-user flexibility. Nevertheless, we assume that 75% of the EV charging occurs in residential buildings, 15% of the charging in commercial buildings, and 10% at fast-charging stations.

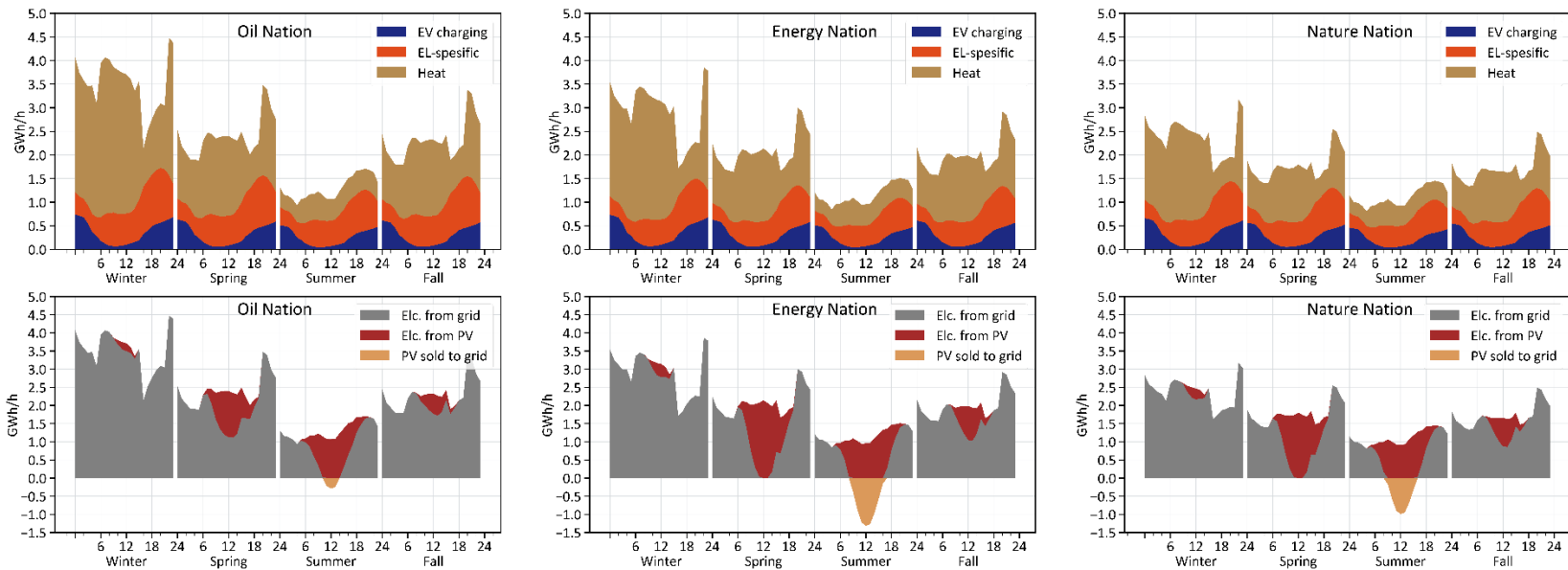

Figure 46: Demand (top) and supply (bottom) for residential buildings in the three storylines Oil Nation (left), Energy Nation (mid), and Nature Nation (right) for the spot region NO1 in 2050.

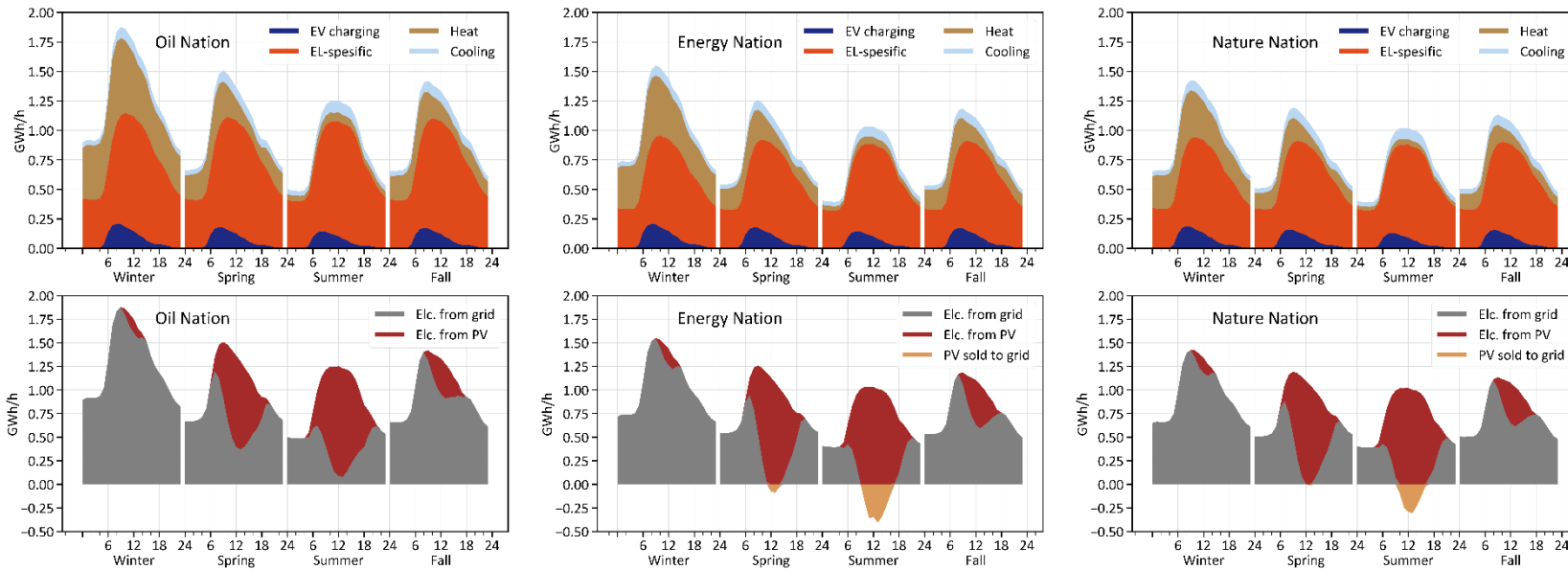

Figure 47: Demand (top) and supply (bottom) for commercial buildings in the three storylines Oil Nation (left), Energy Nation (mid), and Nature Nation (right) for the spot region NO1 in 2050.

Table 18: Peak demand for residential buildings in 2050.

Results, Residential	Storyline	NO1	NO2	NO3	NO4	NO5
Peak demand (GWh/h)	Oil	4.48	2.46	1.48	0.81	0.98
	Energy	3.87	2.13	1.28	0.72	0.85
	Nature	3.18	1.74	1.05	0.58	0.70

Figure 47 demonstrates the supply and demand of commercial buildings in 2050 (in power capacity) for the three storylines for NO1. The results demonstrate that there is a better correlation between demand and PV generation for commercial compared to residential buildings. In total, the demand from the grid is lowered by 3.2 TWh in the *Oil nation*, 5.3 TWh in *Energy nation*, and 4.7 TWh in *Nature nation* due to PV on commercial buildings. As seen in Table 18 and 19, peak demand over the year is only marginally lowered for NO1 and NO2 in all storylines, as the peak demand happens during hours of low PV. The shift in peak demand between the storylines is mostly due to energy efficiency measures.

Table 19: Peak demand and supply, and corresponding time slice, for commercial buildings in 2050.

Results, Commercial	Storyline	NO1	NO2	NO3	NO4	NO5
Peak demand (GWh/h)	Oil	1.88	1.00	0.68	0.47	0.47
	Energy	1.55	0.84	0.56	0.43	0.40
	Nature	1.43	0.74	0.44	0.26	0.36
Peak demand Time Slice	Oil	WI_10	WI_14	WI_10	WI_11	WI_10
	Energy	WI_10	WI_14	WI_10	WI_10	WI_10
	Nature	WI_10	WI_11	WI_10	WI_11	WI_11

5.3.7 Sensitivity: Impact of the EV charging profile

In the results above, it is assumed a non-flexible EV-charging, which is illustrated for according to Figure 48, for *Energy nation* in 2050. Note that it is both the charging location and the time of charging that is fixed for the storylines. We assume that the charging occurs 75% in residential buildings, 15% in commercial buildings, and 10% at fast-charging stations. Figure 49 illustrates that the electricity consumption for EV charging is highest in winter and lowest in summer due to the temperature-dependent electricity consumption of EVs. Note that the EV charging characteristics is set identical for the three storylines but that the power demand level, varies with the storyline specific transport demand projections.

How to include flexible EV charging, both between location and in time, in TIMES-Norway is considered as a part of further work. To get an indication of how a different EV charging pattern can influence the cost-optimal energy system development, we analyze sensitivity of the storylines where we assume a flat EV charging profile as according to Figure 49. Note that this is not considered a realistic future situation but is only included to analyze the effect of a flatter electricity consumption.

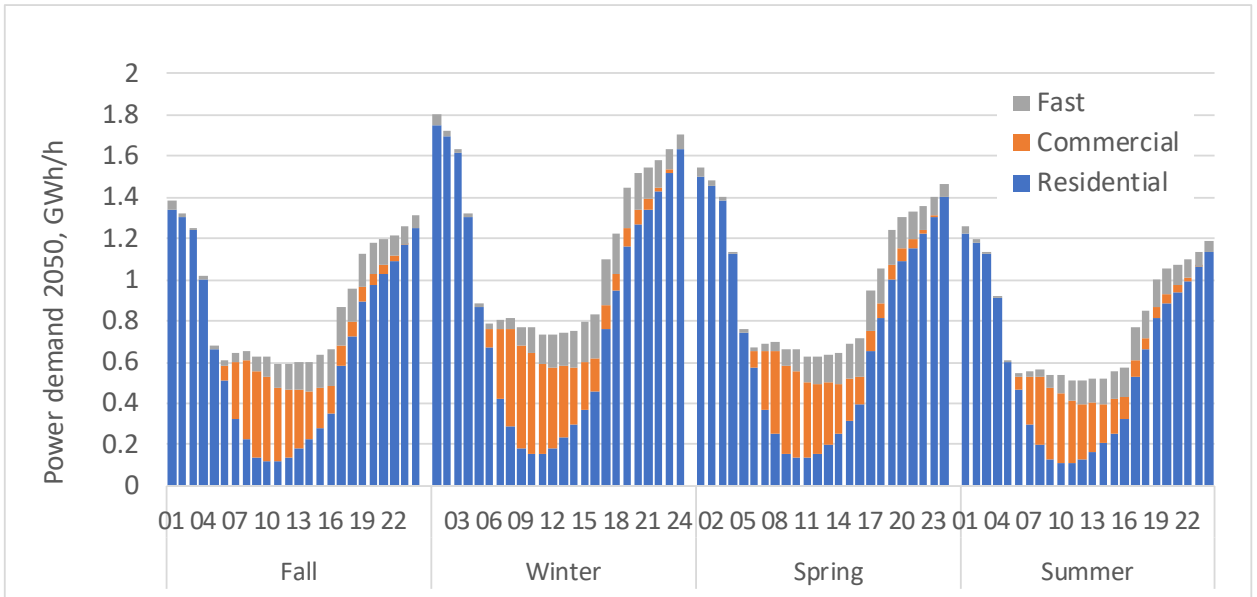

Figure 48: Norwegian electricity consumption for EV charging for Energy nation in 2050.

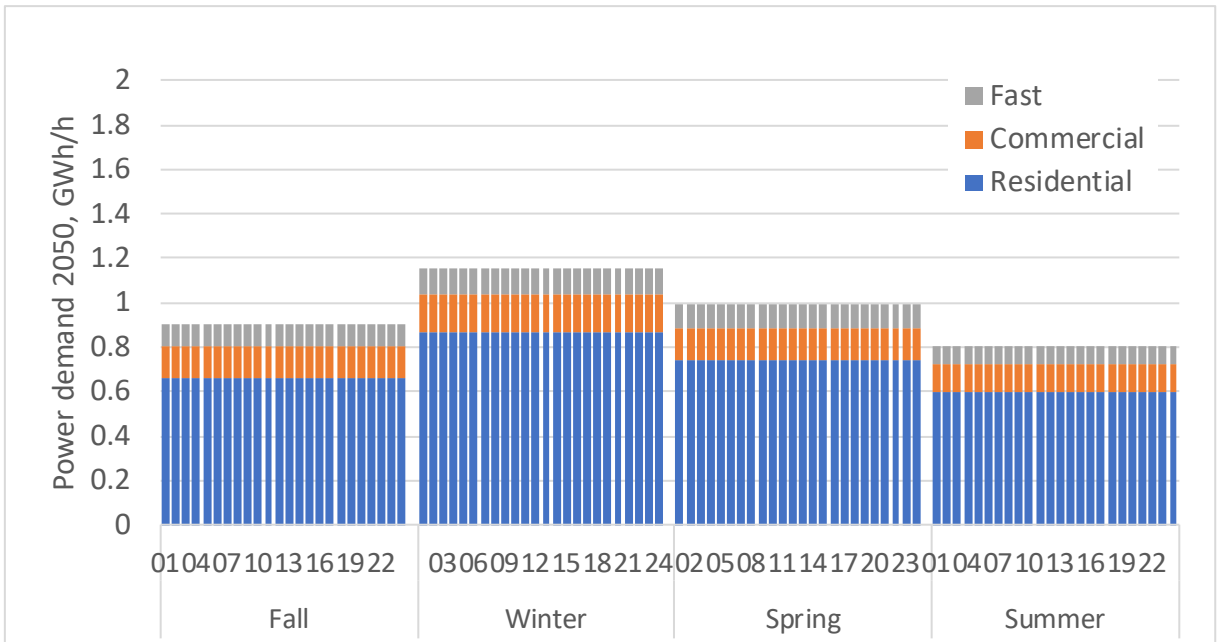

Figure 49: Sensitivity - Flat electricity consumption for EV charging for Energy nation in 2050.

The model results indicate that the EV charging profile has some impact on the investments in electricity generation technologies, electricity consumption, and electricity trade and that the effect varies with the storylines. Table 20 illustrates the differences in PV generation, with a basis and flat EV charging profile, for the three storylines. We observe that the charging profile characteristics have the largest impact on the PV generation for *Nature nation*, where the flat EV charging profiles gives 1.9 TWh and 1.2 TWh more PV generation in 2040 and 2050 consequently. This implies that the use of end-use flexibility can increase the cost-optimal investments in PV generation.

Table 20: PV generation with basis EV charging profile and a flat EV charging profile.

Results	Storyline	2020	2030	2040	2050
PV generation (TWh)	Oil	0.1	0.0	2.7	7.7
	Oil-Flat	0.0	0.0	2.9	7.9
	Energy	0.1	0.7	8.3	14.7
	Energy-Flat	0.1	0.7	8.6	15.1
	Nature	0.1	0.0	10.4	12.2
	Nature-Flat	0.1	0.0	12.4	13.3

5.3.8 Sensitivity: Impact of charging profile of hot water tank

The hourly variations of hot water demand in the model are shown in Figure 50. As illustrated, there are no seasonal variations in hot water demand. How to include flexible electricity consumption for hot water tanks in TIMES-Norway is considered as a part of further work. Like the EV charging curve, a first try to investigate the effect of a flexible hot water tank is to analyze a sensitivity with a flat demand curve. Note that this is not considered a realistic future situation but is only included to analyze the effect of a flatter electricity consumption.

Figure 51 shows the electricity consumption in NO1 in the *Energy nation* for both when hot water demand is as the basic assumption and flat. Note that it is only hot water demand for residential buildings with an electric heat water tank that is flattened. As illustrated, the difference in electricity consumption is marginal; the potential in a change of demand is at most about 0.1 GWh/h for NO1. Nevertheless, this does not indicate that flexible electricity use for hot water tanks cannot be valuable to, e.g., lower consumption peaks in the distribution grid.

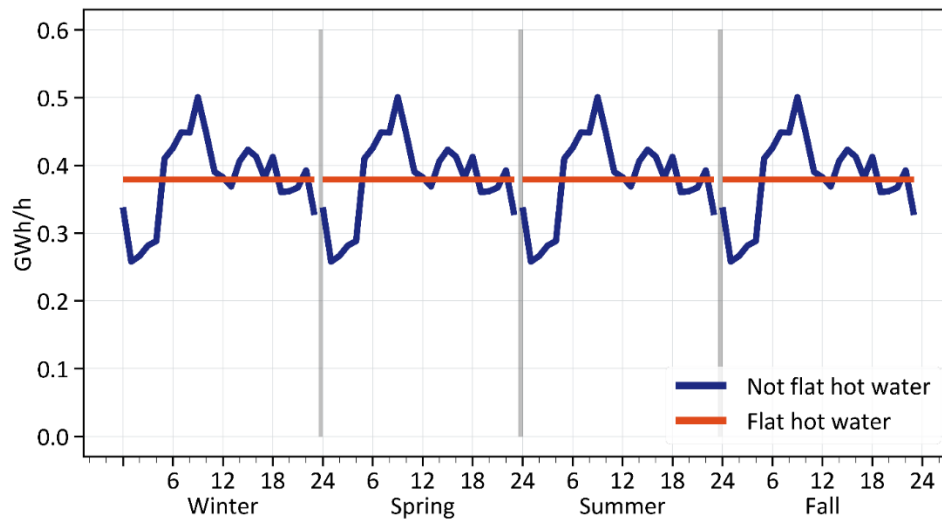

Figure 50: The hot water demand in NO1 in 2050.

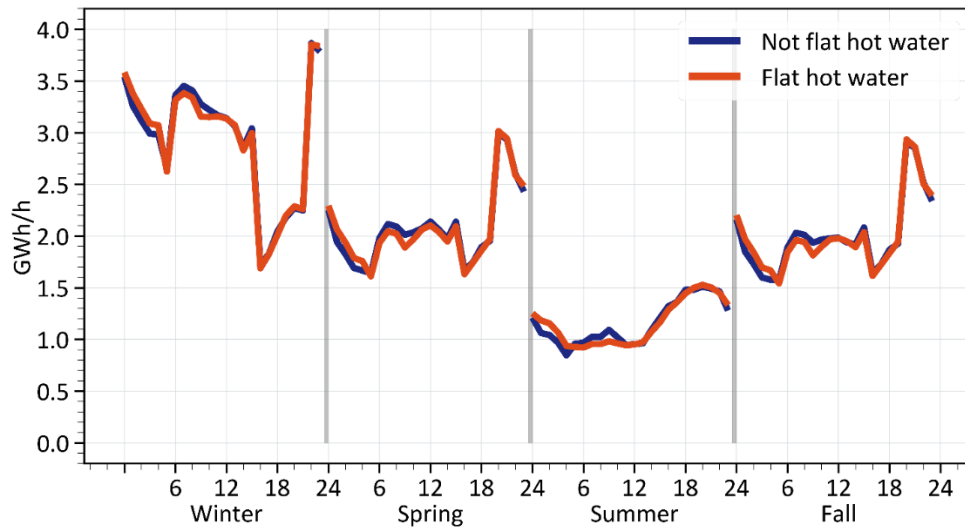

Figure 51: Electricity demand for residential buildings in NO1 in Energy Nation.

5.3.9 Sensitivity: Impact of electricity grid tariffs for solar power

In the results above, it is assumed that PV generation is exposed to the same distribution electricity grid tariffs as electricity supply from the electricity grid, except the cost of grid loss that is assumed to 5 øre/kWh. To illustrate the impact on how the energy system development can differ with how local PV production is exposed for grid tariffs, we show a sensitivity run where local PV generation is not exposed to a grid fee. This is like how small customers are exposed to grid tariffs for solar power today.

Table 21 shows how the PV and wind generation is influenced by the exemption of grid tariffs on local electricity generation. A first obvious observation is that no tariffs for local PV generation give more investments in PV since it increases the value for local electricity generation. For example, in 2050, the PV generation is increased with 1.1 TWh, 4.8 TWh, and 2.1 TWh for *Oil*, *Energy*, and *Nature nation*, respectively, when local PV generation is exempted from a grid tariff. Another observation that is not as intuitive is that the increased PV generation also increases wind power investments. In 2050 the wind generation is increased by 0.3 TWh and 1.2 TWh for *Oil* and *Energy nation*, respectively. There can be several reasons for this. The additional PV generation influences the electricity price, the electricity trade, and the end-use of electricity. For example, for the *Energy nation*, the transmission capacity is slightly increased from the NO3 to the NO4 model region, with more PV.

Table 21: PV and wind generation with local electricity generation exposed to the grid tariff and no grid tariff.

		2020	2030	2040	2050
PV generation (TWh)	Oil	0.1	0.0	2.7	7.7
	Oil-notariff	0.1	0.0	2.9	8.7
	Energy	0.1	0.7	8.3	14.7
	Energy-notariff	0.1	0.7	10.1	19.5
	Nature	0.1	0.0	10.4	12.2
	Nature-notariff	0.1	0.0	11.4	14.6
Wind generation (TWh)	Oil	13.5	22.4	24.6	24.7
	Oil-notariff	13.5	23.0	24.9	24.9
	Energy	13.5	21.5	36.1	37.2
	Energy-notariff	13.5	22.4	37.6	38.4
	Nature	13.5	14.5	12.8	0.0
	Nature-notariff	13.5	14.5	12.8	0.0

5.4 Suggestions for further work

The plan for further work will be prioritized after feedback for the user partners in FlexBuild. The description of further work below is, therefore, only suggestions for further work that will be revised after the user partner feedback. From our perspective, there are three important topics for further work that are shortly described below (not in prioritized order).

A first prioritization of further work is to include stochastic modeling of the short-term uncertainty related to PV generation, wind power, and heat demand. This is because a deterministic model, with only one operational scenario, can give misleading insights regarding future investment needs and the value of end-use flexibility. By using stochastic programming, we can provide investment decisions that explicitly consider different operational situations that can occur due to outcomes of weather-dependent model parameters. Our hypothesis is that a model that covers several operational situations that can occur, here represented by N stochastic scenarios, is necessary to capture the need for end-user flexibility. For example, an average operational situation does not necessarily cover the need for end-user flexibility.

A second prioritization is to include explicitly model end-user flexibility measures in TIMES-Norway. This includes, e.g., district heat and thermal storage in buildings, flexible EV charging, and flexible heating of hot water tanks. This is to analyze the value and the impact of end-use flexibility from a Norwegian energy system perspective. Note that these analyses require stochastic modeling of model parameters that are exposed to short-term uncertainty.

A third prioritization is to further develop the linking and harmonization strategy with EMPIRE and BUTLER. The linking with EMPIRE will be designed to capture the interaction between the European power market and the Norwegian energy system. The linking with BUTLER will be designed to understand which buildings details that are important to consider in the cost-optimal development of the energy system. Furthermore, a comparison with BUTLER will be used to investigate whether there is a mismatch between cost-optimal decisions from a building only and an energy system perspective.

5.5 Appendix A – Technical assumptions of the building sector

Tabell 22: The efficiency of air-air heat pumps and air-water heat pumps.

Description	Efficiency /COP	Utilization Factor	Market Share	LIFE	INVCOST	INVCOST 2035	FIXOM	VAROM
		Existing/ New	Existing/ New	years	NOK/ kW	NOK/kW	NOK/ kW	NOK/ MWh
Residential								
Central heating								
Biomass boiler	0.81	0.32		15	12 876	12 618	938	0.91
Electric boiler	0.98	0.29		20	4 046	4 046	540	0.13
Solar collector	1.00	0.07	0.10	25	10 715	7 501	54	
District heat exchanger	0.99	0.31	0.10	50	4 375	4 375	-	-
Heat pump water-water		0.2/0.37	0.26/0.30	20	20 523	16 418	50	1.88
Heat pump air-water		0.22/0.2	0.54/0.62	15	17 966	14 373	50	1.88
Point sources								
Heat pump air-air		0.22	0.27/0.34	15	6 872	5 498	38	
Wood stove	0.79			25	3 002	3 002	45	
Direct electric heating	1.00	0.29		25	2 042	2 042	31	1.25
Electric water heater	0.98	0.11		20	4 500	4 500		
Non-Residential								
Central heating								
Biomass boiler	0.84	0.32		15	7 897	7 739	520	0.73
Electric boiler	0.98	0.29		20	1 546	1 546	32	0.11
Solar collector	1.00	0.07	0.1/0.05	25	5 714	4 000	29	
District heat exchanger	0.99	0.35	0.3/0.7	50	918	918		
Heat pump water-water		0.37	0.56/0.63	20	15 643	12 514	40	1.50
Heat pump air-water		0.37	0.52/0.60	15	6 790	5 432	40	1.50
Point sources								
Direct electric heating	1.00	0.29		25	1 226	981	18	1.00
Chiller	4.00	1.00		25	3 000	3 000	60	8.00

The model has a stock of existing heating equipment based on energy use in 2018 and full load hours from “NVEs kostnadsrapport 2017”. Existing oil boilers cannot be used after 2020.

The efficiency of air-air heat pumps and air-water heat pumps depends on the season, see Table 22.

Table 2313: Seasonal efficiencies of heat pumps

	Fall	Spring	Summer	Winter
Residential, Air-air	2.5	2.5	2.5	1.5
Residential, Air-water	2.5	2.5	2.5	1.5
Commercial, Air-water	3.0	3.0	3.0	1.5

A maximum market share is assumed for heat pumps and district heating. The maximum share of district heating in dwellings is as a starting point assumed to be 10%, in existing non-residential buildings 60% and in new residential buildings 70%.

Table 24: Market share of heat pumps

Heat pump type	Air-to-air	Air-to-water	Water-to-water
Existing dwellings	27%	54%	26%
New dwellings	34%	62%	30%
Existing non-residential	-	52%	56%
New non-residential	-	60%	63%

For existing dwellings, central heating has a share of 12% of energy demand in 2018, and for new dwellings, it is assumed a share of 60%.

Wood stoves can only be used in winter hours 17-22 (6 hours, from 16 to 23), fall and spring hours 17-20 (4 hours), in order to reflect actual use of wood firing.

6 Hydropower market simulation tools – FanSi

Stefan Jaehnert (SINTEF Energi)

The Norwegian Nordic power generation, with its large share of hydropower, is unique in the European power system. Hydro reservoirs, with their ability to store large amounts of energy and hydropower plants with their ability to change their production rather fast and deliver flexibility, are valuable sources within the ongoing transition of the European power system. However, due to uncertain inflow and storage capability planning, optimal hydropower generation is a complex problem.

Software tools for hydropower scheduling have been developed and applied in the Nordics over several decades. Still, state-of-the-art long-term production planning and price forecasting are based on the water value method for the first time presented in the 60s. Since then, the software tool has evolved gradually and added functionality. However, still, these tools are often based on simplifications and heuristics due to the complexity of the problem. The two major complicating factors in the scheduling problem are:

1. Dynamic couplings. Reservoir storages provide dynamic couplings between the stage-wise decisions in the scheduling problem. Decisions taken today will affect the opportunities (reservoir levels) tomorrow.
2. Uncertainty. Uncertainty about the future state of the system will affect the decisions made today. Normally uncertainties in the long-term scheduling problem are related to weather (inflow, wind, temperature), and inflow is the single most important uncertainty to consider in the Nordic system.

The objective of the project FlexBuild is to assess the value of flexibility delivers from buildings. In the Nordic power system, there is already a large potential for delivering flexibility from hydropower. However, these hydropower generation resources are located remotely and might not be able all the flexibility that is necessary for the future. But for assessing the value of flexibility from different sources in a future Norwegian energy system, it is important to investigate the interaction of these sources in detailed power market models.

6.1 Power market simulation models for hydropower systems

The applied power market model assumes a perfect market and maximizes the expected socioeconomic welfare in hydrothermal power systems. The model serves a given residual electricity demand, which is adjusted by uncertainty in temperature, wind- and solar power generation. For that, a number of scenarios are defined. In order to optimize the hydropower generation, the model includes a detailed description of the hydropower system, including watercourses with several cascaded reservoirs and power plants. The uncertainty in weather parameters is represented by a significant variation in inflow, wind, solar, and temperature conditions from historical weather years affecting electricity generation and consumption. [ref EMPS] Figure 52 depicts this variation. It shows the weekly inflow to Norwegian hydro reservoirs for 30 weather years from 1981 to 2010, where, for example, the energy inflow in week 23 ranges from 338 GWh to 1769 GWh.

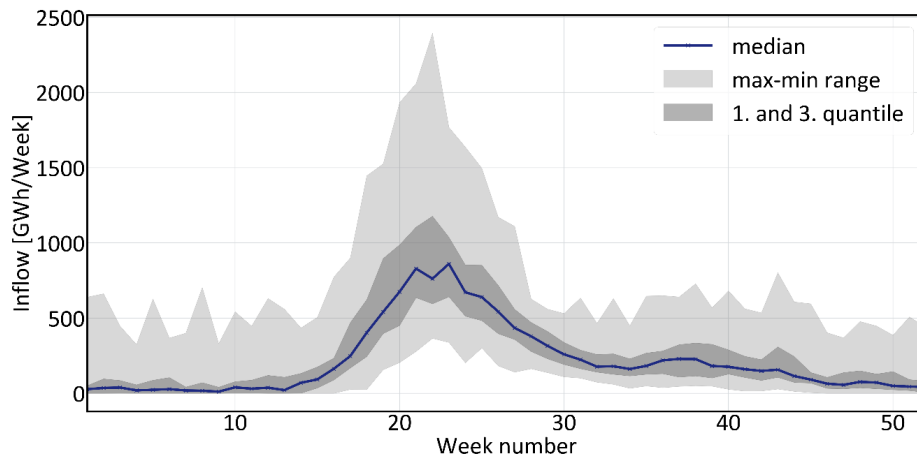

Figure 52: Illustration of weekly hydropower inflow to water reservoirs for 30 weather Years [ref Roadmap].

There exist a number of software models for hydropower optimization, such as the model EMPS, which is applied but a significant number of stakeholders in the Nordic power system. However, the existing power market simulator EMPS is designed for today's power system with limited variability, including a weekly representation. Previous analyses have shown that challenges due to variable power generation and delivery of flexibility from hydropower is not fully captured in this power market model. Hence, focussing on the aim of the project to assess the value of delivering flexibility, a new prototype model, FanSi, is applied. The model FanSi was developed in the project SOVN. The aim was to develop a software optimization model for power systems with a significant share of hydropower based on a formal optimization problem. This means heuristics should be avoided compared to the software model EMPS.

6.1.1 FanSi

FanSi is a power market model for power systems with a significant share of hydropower. The model solves the large-scale stochastic optimization problem of hydropower scheduling for systems with more than 1000 hydro reservoirs and power plants. To assess the delivery of flexibility, a detailed description of the watercourses are included in the optimization problem. Furthermore, the model has a temporal resolution of 1 to 3 hours, representing the variability of vRES. Uncertainty in inflow, temperature, wind- and solar power generation is represented by tens of historic scenarios. To optimize hydropower operation and evaluate the long-term value of water stored in the hydro reservoirs, FanSi applies the optimization method called scenario Fan simulation.

With the Scenario Fan Simulation (SFS), for each time stage, a *scenario fan problem* (SFP) is solved, and the solution is passed from the first-stage decision on to the next time stage. An advantage of the solution method is the possibility for decomposition and hence parallelization of the software model.

The SFS repeatedly solves sequences of SFPs as follows:

1. for all scenarios s from 1 to S do
2. for all decision stages t from 1 to T do
3. Build and solve the SFP problem $SFP(s,t)$
4. Store results from a first-week decision, $sol(s,t)$
5. Pass on state decision from $sol(s,t)$ to $SFP(s,t+1)$

The procedure is illustrated in Figure 53, where the SFP is built for a given scenario s_1 and for time-steps t_1 and t_2 . The first problem, $SFP(s_1,t_1)$, is built with stochastic variables according to scenario s_1 in the first time step t_1 . In the second decision stage (comprising time steps $t_2 - t_T$), stochastic variables may take values from any of the S scenarios with equal probability. The solution $sol(s_1,t_1)$ is recorded, and the values of the state variables in $sol(s_1,t_1)$ are passed on as a starting point to the next time-step t_2 , as illustrated in Figure 53. Subsequently, a new SFP is built with stochastic variables according to scenario s_1 in the first time step t_2 . In the second decision stage (comprising time steps $t_3 - t_{T+1}$), stochastic variables may take values from any of the S scenarios with equal probability. This sequence is continued until a first-stage solution has been found for all decision stages in the time horizon (t_1,t_N) for the particular scenario (s_1). The same procedure is carried out for scenarios s_2 - s_S .

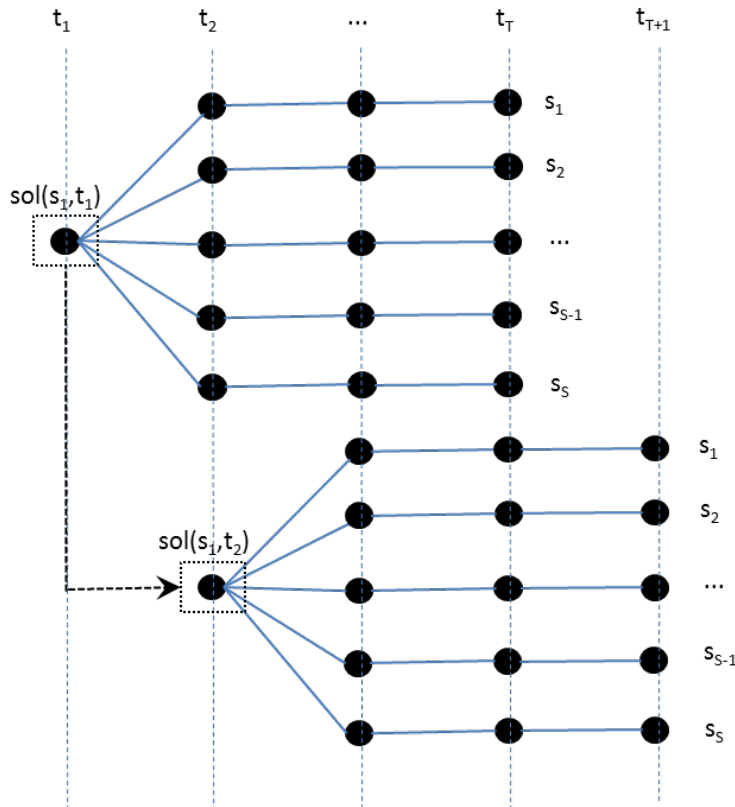

Figure 53: Illustration of SFS logic in FanSi [ref Sovn].

A detailed description of the FanSi model, including underlying mathematics, can be found in [ref Sovn].

6.2 Representing storylines in the Nordic power market models

In order to study the effects of a detailed representation of the Nordic power market on the value of flexibility, input parameters from the defined storylines, as well as results from TIMES will be defined as the input to FanSi. A previous coupling of energy system and power

market models was carried out in the project. However, in this project, the EMPS model was used. In the project FlexBuild, the model FanSi will be run for a number of selected stages within the storylines. However, as the power market models do include a more detailed description of the hydropower system and more throughout representation of the uncertainty for inflow, temperature, wind- and solar power generation, it is necessary to provide additional input data.

For that, scenarios of the Nordic power system for 2030, developed in the FME HydroCen, will be used as a basis. The scenarios specifically contain a description of the expected future development of the hydropower system in the Nordics. In addition, the assumption for the development of cross-border interconnectors is included. The 2030 scenarios developed in the FME HydroCen comprise a *Reference* and a *LowEmission* scenario [ref HydroCen dataset], with the main difference in installed wind and solar power generation capacity. This difference has a significant effect on the electricity price structure, as shown in the selected results below.

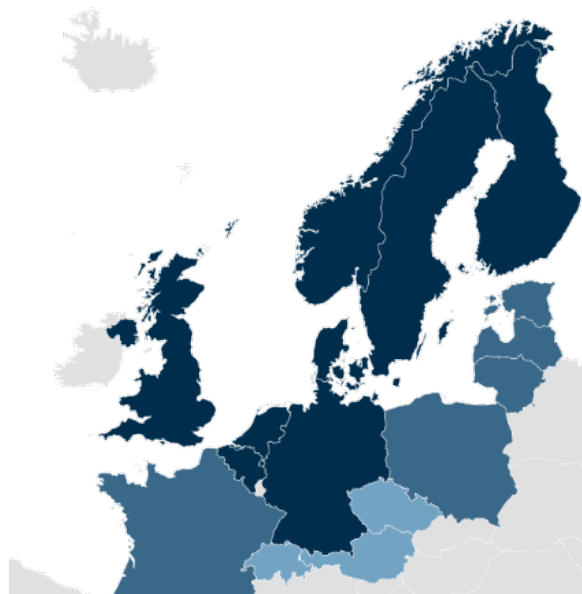

Figure 544: Geographic scope of the dataset [ref HydroCen dataset]

The geographical scope of the analysis with the power market models is shown in Fig. The dataset represents Northern Europe in full detail (dark blue), while neighboring countries are modeled with less detail (light blue). In total, the dataset comprises 57 nodes, including separate areas for offshore wind farms. Thereby, the Nordic system is modeled with a higher number of nodes than the rest of Europe. Norway comprises 11 nodes, excluding offshore wind, in order to represent bottlenecks in the transmission system and different characteristics of the various watercourses. The detailed representation of power generation is achieved.

The analysis uses 58 historical weather years as input scenarios and calculates the optimal hydro dispatch for all of these scenarios. Furthermore, the model is run with a 3-hour. The main inputs to the model include electricity consumption; generation and transmission capacities; fuel and CO2 costs; technology characteristics like efficiencies and physical limitations; and historical weather data like temperatures, inflow, and generation from renewables. Electricity consumption is divided among a fixed share, a temperature-dependent share, and interruptible consumption with a load-shedding cost. Electricity generation from wind and PV is based on hourly generation values for each node.

The following selected results from the scenarios developed in the FME HydroCen are presented and compared to input from the defined storylines and results of the TIMES model. Figure 55 depicts the weekly average electricity prices for selected Norwegian regions. Prices show a seasonal variation, most prominent in the low-emission scenarios. These average prices defined the basis of the revenue for hydropower production. Thereby the price level is defined by alternative power generation technologies. A changing price level has a significant effect on the profitability of hydropower plants.

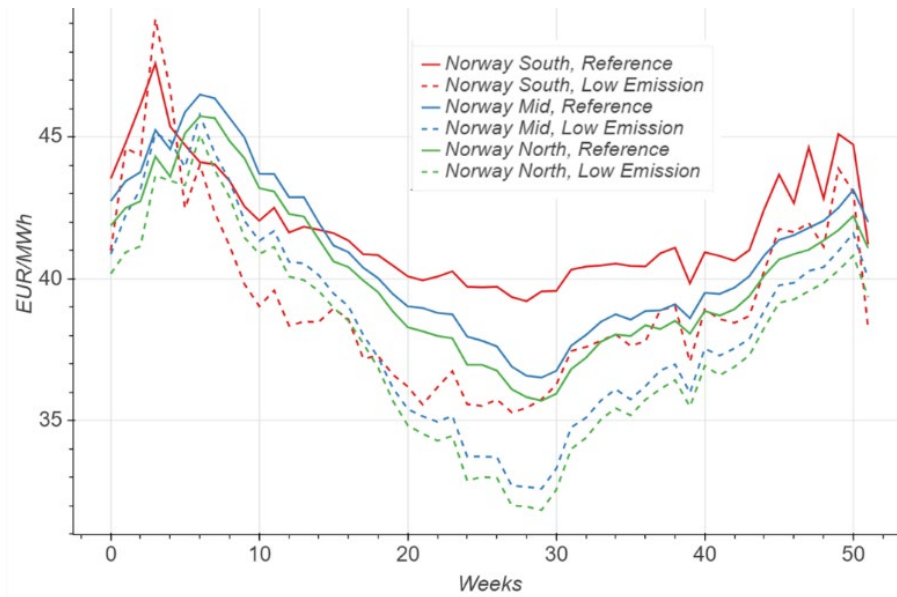

Figure 555: Average electricity prices for Norway in the HydroCen scenarios [ref HydroCen prices]

Electricity prices for three selected historical scenarios are shown in the following figures. The selected historic scenarios thereby represent years with normal (red), high (blue), and low (green) inflow to the Norwegian hydropower system. It can be observed that there is quite some price variability, which is higher in the LowEmission case (figure on the right). Besides the general price level, the price variability affects the profitability of power plants.

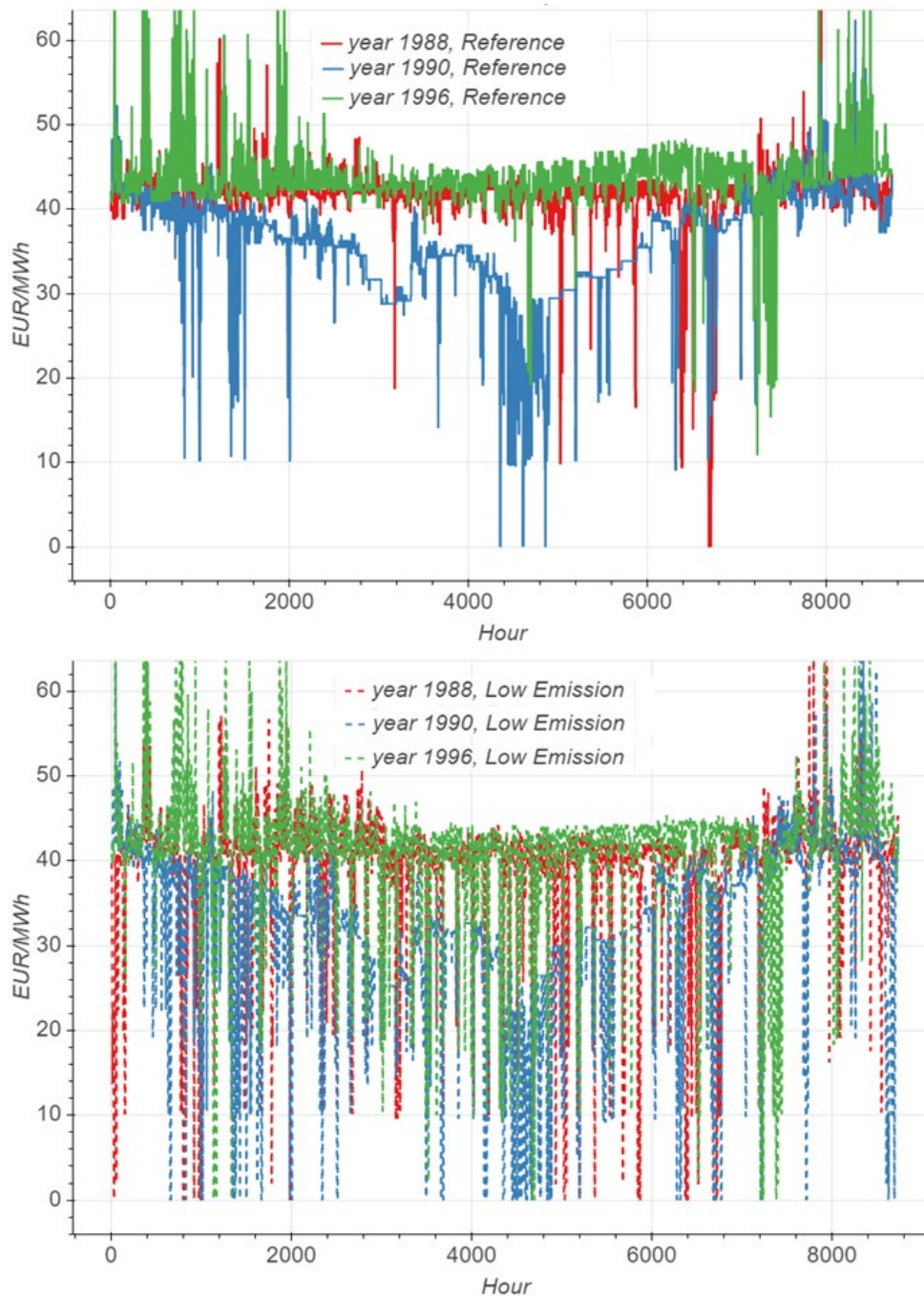

Figure 566: Price variability for selected years in the Reference (left) and Low Emission (right) scenarios [ref HydroCen prices]

Table 25 reports the realized electricity price for selected hydropower plants compared to the average power price. The realized price is the income of a power plant divided by its production. The difference between the realized price and the average price indicates the potential of reacting on price variability, i.e., the value of delivering flexibility from a power plant. In Table 25, it can be observed that the power plant Duge has the highest potential of extra revenue for delivering flexibility, while wind and solar powerplants lose due to price variability.

Table 14: Realised prices for selected hydropower plants [ref power price scenarios]

Plant	Realized power price [€/MWh]		Average power price [€/MWh]		Performance compared to average [%]	
	Reference	Low Emission	Reference	Low Emission	Reference	Low Emission
Blåsjø (Saurdal)	44.2	43.5	41.9	39.5	105 %	110 %
Aurland 3	44.0	43.0	41.4	38.5	106 %	111 %
Tonstad (Tonstad)	43.2	42.2	42.0	38.7	103 %	109 %
Svartevann (Duge)	45.0	44.5	42.0	38.7	107 %	115 %
Wind power Sorland	41.3	37.5	42.0	38.7	98 %	97 %
Solar power Sorland	40.8	34.4	42.0	38.7	97 %	89 %

Finally, Table 26 provides a comparison between the HydroCen LowEmission scenario and the storylines defined in FlexBuild for Norway for 2030. It can be seen that the total power balance (net exchange) is similar in the scenarios. However, hydropower production is assumed lower in the HydroCen scenarios—the same accounts for the total generation and the demand in the Norwegian power system. The difference in hydropower production might be explained by the different ways of modeling hydropower in the TIMES model and the FanSi model. However, it needs to be taken into account that the potential for hydropower production is largely defined by the available inflow to the hydropower system, which cannot be increased without constructing new large hydro reservoirs.

Table 15: Differences between TIMES and power market simulation

	Load [TWh]	Generation [TWh]	Hydropower [TWh]	Wind (potential) [TWh]	Net import [TWh]
HydroCen (LowEmission)	146	153	130	23	-7
Oil	164	178	156	22 (26)	-7
Energy	151	178	156	21 (48)	-19
Nature	146	172	157	15 (15)	-19

6.3 Further work

The aim of further development is to align the model analysis with TIMES and FanSi and to provide better insight into price variability and the value of delivering flexibility in the power system for energy system analysis. For that, it is important to use results from the TIMES model for the different storylines.

6.4 References

[ref EMPS] Wolfgang, Ove, Arne Haugstad, Birger Mo, Anders Gjelsvik, Ivar Wangenstein, and Gerard Doorman. "Hydro reservoir handling in Norway before and after deregulation." *Energy* 34, no. 10 (2009): 1642-1651.

[ref HydroCen prices] Schäffer, Linn Emelie, and Ingeborg Graabak. "Power Price Scenarios-Results from the Reference scenario and the Low Emission scenario." (2019).

[ref HydroCen dataset] Schäffer, L.E., Graabak, I. HydroCen Reference Scenario – Documentation of assumptions. Project Memo. Version 3. 2018. HydroCen. Trondheim, Norway.

[ref Sovn] Helseth, Arild, Birger Mo, Arild Lothe Henden, and Geir Warland. "SOVN Model Implementation: method, functionality and details." SINTEF Energi. Rapport (2017).

[ref Roadmap] Seljom, Pernille, Eva Rosenberg, Linn Emelie Schäffer, and Marte Fodstad. "Bidirectional linkage between a long-term energy system and a short-term power market model." *Energy* (2020): 117311.

7 Comparison of models' results and conclusions

Igor Sartori and Marius Bagle (SINTEF), Asgeir Tomasgard (NTNU)

As it is in the implementation plan of the Flexbuild project, the workflow is the structure in yearly cycles: agreement on inputs and scenarios to analyze, development of the models and their linking, presentation and discussion of the result, feedback from the industrial partner on the priorities for the next cycle.

This Annual Report, which is formally a deliverable in WP3 "Results analysis and dissemination", also includes the agreed deliverables of WP1 "Scenarios and input" and WP2 "Modeling framework" (ref. workplan for the first year). It has seemed convenient and appropriate to organize the reporting on a model-by-model basis, as presented in the previous chapters. This is mainly due to the organization of the work itself, which is model-by-model. However, this should not distract from the fact there has been considerable effort deployed by the research partners in a dialogue about harmonization of the modeling work, their inputs, and the linking methodology. This is a central part of the project itself and is ongoing work, as described in Chapter 3.

Nevertheless, it is worth taking a direct comparison of the results across different models, as far as it is possible after the first cycle. This is presented in the following sub-chapter §8.1.

Finally, sub-chapter §8.2 summarizes the suggested features and challenges to be tackled in the future work of developing the models and their linking, as reported in the previous chapters. Nonetheless, it should be reminded that the industrial partners will have their saying in drafting the priorities of the next cycle/year of project work. This is, indeed, the task of WP4 "User's forum" and the aim of the next Annual Workshop and associated Annual Memo. The final priorities will be defined considering the feedback from the user's forum on the information presented in this Annual Report, including the suggested future work in §8.2.

7.1 Comparison of models' results

As described in Chapter 3, the linking between the models is an ongoing development, and so the extent to which results from different models can be compared is somewhat limited at this stage of the project. The aim of the linking methodology is to achieve a bi-directional linking strategy with clearly defined convergence criteria, between TIMES-Norway and the other sectorial models, to gain consistency between the model results. However, in this first year, only uni-directional linking has been implemented. For example, TIMES-Norway receives at electricity prices for other countries from EMPIRE, but it has not been checked if the results from TIMES-Norway would, in turn, affect the initial EMPIRE simulation.

The most important linking is between BUTLER and TIMES-Norway, both because the end-use flexibility (from the building sector) impact on the energy system is the central focus of this project – while influence from the European power market and impact on the Norwegian hydropower system are boundary conditions – and because the results of these two models are mostly interdependent. However, in this first year, the main focus has been different for the two model developments. BUTLER has focused on developing some of its technologies descriptions and on investigating the impact of different grid tariff schemes on the investment and operation of heating technologies in single buildings. On the other hand, TIMES-Norway has focused on the implementation of the Storylines. Therefore, it is worth comparing the results of the two models to assess what their level of convergence is before the linking methodology is fully developed and applied.

As discussed in Chap.3, electricity prices and district heat prices from TIMES-Norway are used as an input to BUTLER. The next step is to use the demand for electricity and district heat from BUTLER to TIMES-Norway (and possibly iterate the process until there is a

convergency). However, until now, both models calculate their own electricity and district heating demands, as a result of their in-built optimization algorithms. We could say that both models perform the same task "without talking to each other" (yet). This is due to how the models are built and to the fact that normally they are meant to run as self-standing models. However, weather data and technical data in input to both models have been harmonized (ref. to the model's respective chapters for further details). Given this starting point, how similar are the two models' results?

Figure 57 and Figure 58 show a comparison side-by-side of the result from BUTLER and TIMES-Norway for the Residential and Commercial sector, respectively. Some clarification is needed to understand the comparison.

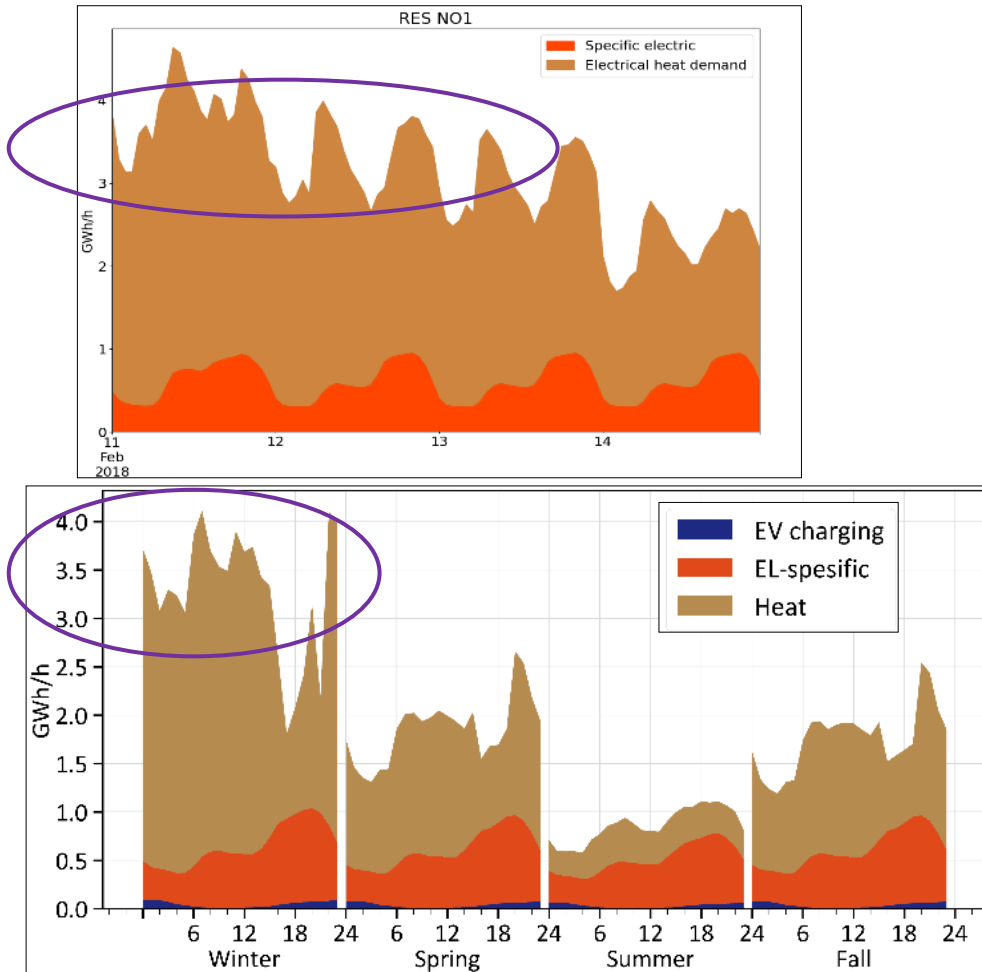

Figure 577: Comparison of BUTLER (left) and TIMES-Norway (right) results on electricity demand for the Residential sector, aggregated for region NO1 in the year 2020. The purple ovals encircle the curve shapes to be compared.

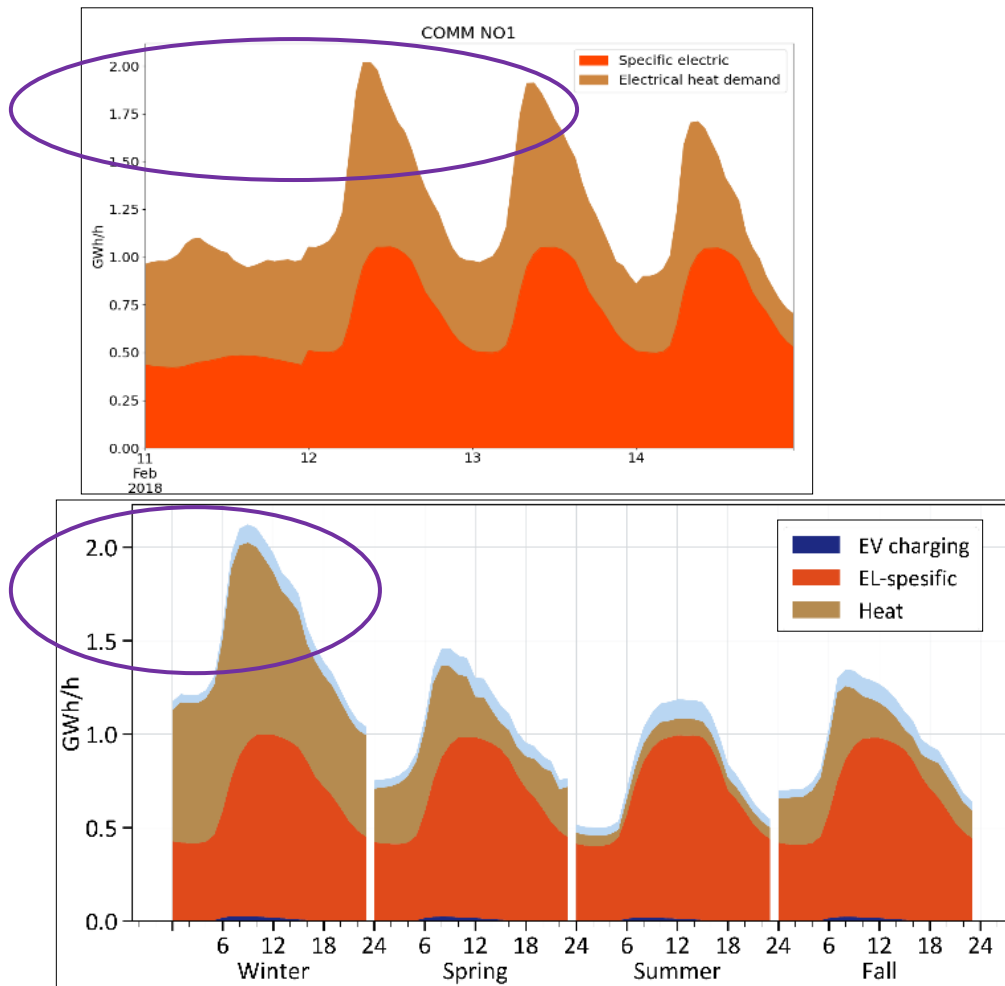

Figure 588: Comparison of BUTLER (left) and TIMES-Norway (right) results on electricity demand for the Commercial sector, aggregated for region NO1 in the year 2020. The purple ovals encircle the curve shapes to be compared.

Both model's results are at the aggregated level for the region NO1 and for the year 2020. Weather data (such as outdoor temperature that influences significantly the heating demand) and technology data (such as the amount of buildings having a waterborne heating system and the heating demand covered by district heating in the initial year) are harmonized. Although 2020 is the starting year for how the models are built, the results already contain some influence from the optimization algorithm. In particular, the choice of heating technologies may vary somewhat between the two models, for example, in the number and type of heat pumps installed. It should also be mentioned that the load from EV charging is considered in TIMES-Norway but not in BUTLER. The impact of this load is minimal in 2020. Cooling demand is considered in both models, although in BUTLER, it is seen as part of the electric specific demand and so it is not explicitly visible in these result figures. As for electricity and district heating prices, these are those calculated by TIMES-Norway for the year 2025 for the Energy nation storyline.

As for the grid tariff, on the other hand, TIMES-Norway only considers a flat tariff structure. It is therefore chosen to compare the results with those obtained from BUTLER when applying the Energy pricing tariff.

Finally, it should be noticed that TIMES-Norway simulates four average days per year (one for each season). This is to reduce the computational complexity, thus allowing the stochastic modeling of short-term uncertainties to be introduced in the next year of the project. BUTLER

– that also reduces the number of days simulated to 4x168 hours per year when introducing stochastic modeling – has been simulating an entire year, i.e., 8760 hours. Therefore, Figure 57 and Figure 58 show for BUTLER a representative winter period of four days.

Given the above considerations, it is not expected that the two model's results would be identical. Nevertheless, looking at the end-of-sale in the y -axis and the shape of the demand curves (average winter day for TIMES-Norway, series of a 4-days representative period for BUTLER), it may be concluded that there is substantial agreement between the two models. This is encouraging because it shows that once the two models are fed with harmonized input, one obtains harmonized outputs despite the inner technical differences. On the other hand, it looks promising to aim at the convergence of two models (with a limited number of iterations) with a bi-directional linking (in this case TIMES-Norway feeding energy prices into BUTLER and BUTLER feeding energy demand back into TIMES-Norway) when the results are already substantially similar, even when there is a simple uni-directional link.

7.2 Future work

The following points are the summary of the future work proposed by the research partners:

- *Storylines*: continue with the definition of datasets and assumptions that quantify the storyline description in a consistent and harmonized way across the models
- *Linking methodology*: the next step of the linking between TIMES-Norway and the sectorial models is to develop a bi-directional linking strategy with a clearly defined convergence criterion
- *EMPIRE developments*: this will be defined within the Ph.D. plan with the candidate
- *BUTLER developments*:
 - continue with heating technologies improvements, especially heat pumps
 - improve the modeling of storage technologies: hot water tank, battery, and EV
 - Implementation of the thermal mass dynamics of buildings
- *TIMES developments*:
 - include stochastic modeling of short-term uncertainty related to PV generation, wind power, and heat demand
 - Include modeling of end-use (storage) flexibility measures: hot water tank and EV flexible charging, storage in district heating, and (comfort) flexibility: thermal storage in buildings
- *FanSi developments*:
 - define datasets and other boundary conditions that are coherent/compatible with the Storylines, with the necessary level of detail to account for the short-term uncertainties for inflow, temperature, wind- and solar power generation
 - assess the power price structure and profitability of hydropower and potential other flexibility options within the power system for the developed storylines

The final priorities for future work in the next year of the project will be defined considering the feedback from the industrial partners, included in their Annual Memo (AM.1). From the Workplan 2019-20:

AM.1) Annual impact assessment memos

A memo will be produced to summarize the input from the user partners as well as the relevant insights from the project on those topics.

Flexbuild Annual Report 1

TECHNICAL REPORT WITH RESULTS ANALYSIS

The FlexBuild project will estimate the cost-optimal implementation of end-user flexibility from a socio-economic perspective. The results will quantify the effect of end-user flexibility on electricity consumption in individual buildings, but also on the aggregated national level. What is new in FlexBuild is that the value of end-user flexibility will be analyzed from a system perspective, with a solid stochastic modeling and detailed representation of the building sector. FlexBuild responds to knowledge gaps that have been identified by several actors, both from the supply side (power grid and district heating companies) to the end-user side (building owners) and public actors.