



Research paper

Abandoning peat in a city district heat system with wind power, heat pumps, and heat storage

Nima Javanshir^{a,*}, Sanna Syri^a, Antti Teräsvirta^a, Ville Olkkonen^{a,b}^a Department of Mechanical Engineering, School of Engineering, Aalto University, FI-00076, Aalto, Finland^b Department of Renewable Energy Systems, Institute for Energy Technology (IFE), P.O. Box 40, 2027, Kjeller, Norway

ARTICLE INFO

Article history:

Received 3 December 2021

Received in revised form 25 January 2022

Accepted 6 February 2022

Available online xxxx

Keywords:

District heating

Power-to-heat

Wind power

Thermal storage

Economic analysis

CO₂ emission

ABSTRACT

The Finnish Government has established the target of carbon-neutrality by 2035. In Finland, district heating (DH) networks in most cities rely on carbon dioxide (CO₂) intensive fuels such as coal and domestic peat. This study assesses the decarbonization of a Finnish city's DH by employing power-to-heat (P2H) technologies, including heat pumps, an electric boiler, and thermal storage together with an ambitious building energy renovation program. This study also aims to use wind power with a calculated fixed price instead of the market price for the electricity consumption of the deployed P2H units to further support electrification and decarbonization of the DH network. Bilateral contract between the wind producer and the DH operator is examined, as new wind power producers receive no subsidies in Finland. The impacts of storage capacity, electricity tax, building-level renovation, and European CO₂ emission allowance (EUA) price on the DH's optimal operation and break-even price of heat production were evaluated. The optimization routine minimizes marginal production costs. The optimal scenario eliminated the carbon intensive fuel peat with more affordable heat prices, due to P2H technologies, lower electricity tax, higher EUA prices, and the renovation of buildings. Bilateral electricity contract can bring mutual benefits for the DH company and the wind producer.

© 2022 The Author(s). Published by Elsevier Ltd. This is an open access article under the CC BY license (<http://creativecommons.org/licenses/by/4.0/>).

1. Introduction

As the northernmost member of the European Union (EU), Finland is among the countries with the highest energy consumption per capita (Finland's environmental administration, 2016). Heating demand accounts for the major share (82% in 2019) of annual energy consumption of households in Finland (Statistics Finland, 2022a). In cities, the district heating (DH) network is the dominant heat source for space heating (Finnish Energy, 2020) and domestic hot water demand or as process heat for industry. The Finnish DH network is now confronted with pressing challenges. The National Energy and Climate Strategy in Finland proposes stringent regulations to phase out coal for energy-producing purposes by 2029 (Fin, 2019; Finlex, 2019). Additionally, the consumption of domestic high-emission fuel peat (emission factor of 107.6 gCO₂/MJ for milled peat (Statistics Finland, 2022b)), which consists of 16.6% of the total fuel share in the DH supply in 2019 (Finnish Energy, 2020), should be diminished by 50% by 2030 (Fin, 2019). Thus, reducing the use of fossil fuels, especially peat, in DH conversion is essential to meet the above-mentioned goals. However, energy poverty is of increasing concern everywhere in Europe, and it is vital to seek low-carbon solutions

that are also affordable and technically reliable (Official Journal of European Union, 2020).

To establish a sustainable and decarbonized heating sector, a comprehensive set of measures is proposed, including increased DH adoption, energy efficiency measures (Heat Roadmap Europe, 2019), and technology development (Javanshir et al., 2019; Siksnylyte-Butkiene et al., 2021). Small modular reactors (SMR), for example, have demonstrated their ability to substitute the fossil-fuel based CHP units in DH networks (Teräsvirta et al., 2020). The electrification of the heating sector through power to heat (P2H) units and sector-coupling is another promising and immediate solution that has been thoroughly investigated in the literature. Using two different technologies, a heat pump (HP) and an electric boiler, the electrification of DH networks in Austria and Denmark was investigated in Sorknæs (2021). Three different scenarios, i.e., a 2015 scenario, a 2050 scenario with low DH market share, and a 2050 scenario with high DH market share was proposed. In this study, the effectiveness of both technologies was reported in terms of reducing biomass consumption and integrating more variable renewable energy resources into the DH network. Wang (2018) explored the potential of different heating options in the UK energy context to reach the government's energy and environmental targets for 2050. To substitute conventional gas boilers and the transition to low-carbon heating, HPs

* Corresponding author.

E-mail address: nima.javanshir@aalto.fi (N. Javanshir).

that consume decarbonized electricity were proposed as promising technologies. The results specified that while the offered technologies could substantially reduce emissions, the levelized cost of heat for HPs and DH is significantly higher than for gas boilers. Zhang et al. (2019) developed scenarios to decarbonize a metropolitan city DH network in China from 2015 to 2030. Using Beijing as the case study, the authors concluded that deploying HPs that cover 25% of the total annual heating demand in 2030 can deliver significant energy and cost benefits and reduce the carbon dioxide (CO₂) emissions of Beijing's heating system in 2030 by 21%. One of the perks of deploying HPs in a DH network is that HPs can handle a variety of available heat sources in a region. Spirito et al. (2021) conducted a techno-economic analysis to examine the possibility of incorporating local renewable and surplus heat sources into a northern Italian city's district heating network. Four different scenarios were used in EnergyPro to simulate the optimal operation of the DH network. According to their study, HPs can provide 90% of the heating demand by using waste heat sources from nearby steelworks and wastewater plants.

In Finland, the role of P2H units, particularly HPs, in decarbonizing DH network in Finland has been studied. Kontu et al. (2019) examined the viability of integrating large-scale HPs into current DH networks in Finland by a simulation and interviews with DH specialists from industry. Three types of DH networks, i.e., small, medium, and large, were simulated to assess the influence of HPs on the production cost in each DH network. Results outlined that the largest potential for HP is in small systems, while due to economical CHP production in medium and large DH networks, the potential of HPs is smaller. The authors also mentioned that the installed HP capacity in Finland (3%) is significantly lower than the potential capacity (10%–25%). Paiho and Reda (2016) reviewed feasible solutions for a transformation of current Finnish DH networks to the next generation, adaptable to new European regulations. In their article, HPs, solar thermal collectors, and thermal storages were proposed as effective technologies. In Abdurafikov et al. (2017), DH network development and decarbonization pathways in Southern Finland were analyzed under the EU obligations for 20 years (2015–2035). The authors simulated an existing DH network by employing solar collectors, waste heat, and ground source heat pumps (GSHP) in different scenarios. Reductions of 34% using GSHPs and solar collectors and 32% using industrial waste heat in the annual centralized heat production were achieved.

To provide flexibility between electricity and heating sectors, paving the way for a wider integration of renewable production, thermal storage was proven to be a key option (Paiho et al., 2018). The role of HP and thermal energy storage in providing flexibility, accommodating a more diverse range of renewable energy sources, and minimizing operating costs in DH systems was discussed in Siddiqui et al. (2021). Model predictive control was used to simulate a zero-emission electricity generation scenario. The study concluded that a storage size of around 1% of the annual demand is sufficient for minimizing operating costs. Todorov et al. (2020) reported the economic and environmental benefits of deploying groundwater HPs combined with aquifer thermal energy storage into an existing DH and district cooling network in Finland as an alternative to traditional fossil fuel boilers. To solve the mismatch between the heat supply from a data center and DH heat demand, Li et al. (2021) introduced a water tank and borehole thermal energy storage in a campus DH network in Norway. A water tank could shave the peak load by 31% and save annual energy costs by 5%. The borehole thermal energy storage increased the waste heat utilization rate to 96% and reduced annual CO₂ emissions by 8%.

The decarbonization of DH networks through P2H units, thermal storages, and renewable energy resources has been well

documented in the literature. This study examines the benefits of P2H units and wind power integration into a DH network from both purely economic and energy viewpoints in countries like Finland which do not subsidize wind power. This contribution investigates decarbonizing a mid-size Finnish city's DH network that depends on local high-emission fuel peat by an electrifying technology portfolio (large HPs and electric boiler) and thermal storage to meet the climate targets of 2030 and 2035. To further enhance the electrification and decarbonization of the DH network, wind power is provided for the electricity consumption of the P2H units on the DH side. The DH network receives wind power with a fixed annual price through a bilateral contract between two parties, i.e., the wind producer and the DH operator. The purpose is to investigate any mutual benefits achievable for both a wind power producer with no subsidy and the DH company as a secured customer with a long-term bilateral contract between them. Currently, the Finnish electricity market differs from most other EU countries in that wind power is being constructed without any subsidy mechanisms, i.e., it is fully market-based (Finnish Wind Power Association, 2021). In countries where wind power is currently still constructed with the help of subsidies, this will be a critical question when the subsidies end.

In this regard, different scenarios are developed for the reference year 2019. Sensitivity and economic analyses are conducted to evaluate the performance of the proposed model in terms of fuel consumption, heat production cost, and environmental sustainability, as indicated in this study by CO₂ emissions. Furthermore, an optimization routine has been developed to discover the optimal operation in terms of the minimum heat production cost. In this study, the following research questions are answered:

- *The system with low-carbon technologies:* How can the dependence of DH networks on carbon-intensive fuels be reduced to meet the climate targets of 2030 and climate neutrality by 2035 by integrating a wind farm, HP, electric boiler, and heat storage into the DH network when wind power must be constructed without any economic subsidies? How much can ambitious building energy renovation programs contribute? How much can CO₂ emissions be reduced annually?
- *Economic analysis:* How would the DH heat production cost be affected? How would be the profitability of the proposed system change? Could a bilateral contract between the DH operator and the wind power producer provide mutual benefits?
- *Sensitivity analysis of design and policy:* How do electricity distribution fees and taxes affect the optimal operation of the system and heat production costs? How does thermal storage volume affect the heating cost? What is the role of European CO₂ emission allowance (EUA) price in heat production costs?

2. Methods and materials

The DH network is modeled in EnergyPro (EnergyPRO, 2020), the commercial software used in several articles to model complex systems (Johannsen et al., 2021; Kazagic et al., 2019; Østergaard and Andersen, 2021). The optimization routine is to minimize the net heat production cost based on the marginal production costs of units, including fuel costs and taxes, carbon costs, and variable operation and maintenance (O&M) costs.

Table 1
Input data used in the simulations (Carbon Price Viewer - Ember, 2021; Kuopio Energy, 2019; Statistics Finland, 2022a,b,c,d; Teräsvirta et al., 2020).

| Year | Heat demand (GWh) | Biomass cost (€/MWh) | Peat cost (€/MWh) | | | Oil cost (€/MWh) | | | EUA price (€/tCO ₂) |
|------|-------------------|----------------------|-------------------|-----|-------------|------------------|------|-------------|---------------------------------|
| | | | Fuel cost | Tax | Carbon cost | Fuel cost | Tax | Carbon cost | |
| 2019 | 997 | 18.2 | 16.0 | 3.0 | 15.49 | 40.0 | 27.5 | 10.53 | 40 |

2.1. Description of the case study DH network

In the DH network case study, Kuopio city in Eastern Finland, there are two combined heat and power (CHP) plants for baseload heat production in 2019. Peak demand is met by scattered oil-fired boilers, aggregated into one unit (Peak). The reference system also includes a CHP-biogas unit, which consumes biogas from a wastewater treatment plant as fuel (Kuopio Energy, 2019). The technical parameters of CHP units, including their minimum loads, minimum operation and non-operation periods, and maintenance breaks, were obtained through industry interviews in Teräsvirta et al. (2020). The hourly distribution of outdoor temperature (Finnish Meteorological Institute, 2021) and electricity spot prices (Nordpool, Day-ahead market, 2021) are used in the simulations. Table 1 summarizes the input data used in the simulation for the reference year 2019.

2.2. Description of the proposed scenarios

Five scenarios are proposed to assist in the effort of decarbonizing DH production. In scenarios 1 and 2, three HPs with different heat sources are employed, including ambient air, wastewater, and geothermal heat; a 20 MW electric boiler operating at times with surplus electricity production with lower prices (Böttger et al., 2015); and sensible heat storage containing a 25,000 m³ hot water accumulator. In scenarios 3 to 5, wind power with a fixed annual price is provided for all P2H units instead of power coming from the main grid. The objectives are twofold. First, although CO₂ emissions from electricity consumption are low in Finland (with an average emission factor of 0.091 tCO₂/MWh in 2019 (Fingrid, 2021b,a), wind power further helps to reduce emissions caused by the electricity consumption of the units. Secondly, P2H units can gain more priority over CHPs as they consume wind power at lower prices than the day-ahead electricity market prices, especially in winter when prices are high. Detailed explanations about the calculation of wind power sales price to bring mutual benefits for both sides are presented in Section 2.4. A hypothetical wind power park is simulated using the local wind speed from Renewables.ninja (2021), and the power curve of the turbine (“Wind turbine models”, n.d.) for the reference year 2019. Detailed explanations regarding the wind turbine characteristics and connection to the transmission network are summarized in Appendix B.

Scenarios 4 and 5 are simulated according to the future assumptions regarding the decreased electricity tax (tax category 2 in Table 5) planned by the Finnish government, escalated EUA prices (Carbon Price Viewer - Ember, 2021; Official Journal of European Union, 2003), a low-temperature DH (LTDH) network, and finally, with reduced heating demand due to renovations of building stock in the studied region. The renovation measures include the installation of building-level exhaust air or ground-source HPs, low-temperature radiators, solar thermal systems, ventilation, and heat recovery systems, as well as improving the thermal insulation level of the walls and roof (Hirvonen et al., 2021). Two different cost-optimal energy retrofit scenarios – the lightly retrofitted (Renovation 1) and the heavily renovated and thus more costly (Renovation 2) – are considered in scenarios 4 and 5, respectively (Hirvonen et al., 2018). Heating demands

in scenarios 4 and 5 are therefore calculated according to building stock data in the region (Building stock in Kuopio Opasnet, 2021). Notably, the mentioned investment costs of renovations are covered by the building owners, and therefore, in this study, renovation costs are not considered in the economic analysis of the DH network. Scenario 4 is simulated with both tax categories to assess the impact of electricity taxation. Table 2 summarizes the main features of the renovation models for buildings built before 1976 in Finland (Hirvonen et al., 2021). A summary of proposed scenarios is listed in Table 3. In addition to the DH network simulation in the studied reference year (2019), the DH network simulation is also conducted in the coldest year (2010) to illustrate the longer-term trend in DH network transformation (Kuopion Energia- Annual report, 2010; Statistics Finland, 2022c,d).

The availability of heat sources used for HPs in the studied region can be justified by referring to existing cases in Finland. Sewage water from a local wastewater treatment plant has been widely used as a waste heat source in a WWHP in Finland (Fortum, Suomenoja power plant, 2019). GSHPs are becoming common technology both in residential and in large commercial buildings in Finland (District Heating Statistics, Finnish Energy, 2021; Kuopio Gate, Adven, 2021). The technical characteristics of each HP are summarized in Table 4 (Friothers A.G. Fortum, 2015; Technology Data, 2016b; Sanner, 2012). Appendix A explains the modeling of HPs in this study. Electricity tax and distribution fees in the region required for the electricity consumption of P2H technologies are listed in Table 5 (Kuopio Energy, 2021).

The schematic of the proposed DH network is illustrated in Fig. 1.

2.3. Investment analysis

In this section, an economic analysis of the DH network is presented. Power produced by CHP units is sold to a competitive market, i.e., the day-ahead electricity market according to hourly spot prices. However, the heating business is a natural monopoly in Finland because there is only one DH network in a particular area (Patronen et al., 2017). Thus, products are priced by adding a profit margin over their costs, as allowed by regulation (Finnish Competition and Consumer Authority, 2021). In this study, heat prices for each scenario are calculated as the break-even price for heat production for the entire network.

The yearly cash flow calculations are expressed through Eqs. (1)–(4) (Brealey et al., 2008). Depreciation value (D) is calculated from Eq. (1) by dividing investment costs (I) over the lifetime of the unit (n). Table 6 contains the investment costs – including equipment purchase and installation expenses and variable operation and maintenance (O&M) costs – for components used in this simulation. Notice that these cost assumptions contain some uncertainty levels, such as the construction location. The reference case’s investment costs are considered as sunk costs. All monetary values are transferred to the reference year (2019), using the currency factor published by Statistics Finland (2022d).

$$D = \sum I/n \quad (1)$$

Earnings before interest and taxes ($EBIT$) are presented in Eq. (2). $E_{E/H}$ and $P_{E/H}$ are the electricity/heat produced and the

Table 2

Main features of the renovation models used. The costs are assumed to be covered by the building owners (Hirvonen et al., 2021, 2018).

| Parameter | Non-renovated model | Renovation 1 (Light renovation) | Renovation 2 (Heavy renovation) |
|---|---------------------|---------------------------------|---------------------------------|
| Heat demand (GWh) | 997 | 768 | 589 |
| Investment cost (€/m ²) | 0 | 159 | 193 |
| Life cycle cost (€/m ² /25a) | 0 | 419 | 437 |

Table 3

Description of the scenarios. The 2019 heat demand and electricity market data are used as the basis in the scenarios.

| Scenarios | Deployed technologies | Power consumption source | Heat demand (GWh) | DH type | EUA price (€/tCO ₂) | Tax category | Renovation type |
|---------------------|---------------------------------------|--------------------------|-------------------|---------|---------------------------------|--------------|-----------------|
| Reference | - | Grid | 997.0 | HTDH* | 40 | Category 1 | - |
| Scenario 1 | HPs, electric boiler | Grid | 997.0 | HTDH | 40 | Category 1 | - |
| Scenario 2 | HPs, electric boiler, Thermal storage | Grid | 997.0 | HTDH | 40 | Category 1 | - |
| Scenario 3 | HPs, electric boiler, Thermal storage | Wind power | 997.0 | HTDH | 40 | Category 1 | - |
| Scenario 4 high tax | HPs, electric boiler, Thermal storage | Wind power | 768.0 | LTDH | 60 | Category 1 | Renovation 1 |
| Scenario 4 low tax | HPs, electric boiler, Thermal storage | Wind power | 768.0 | LTDH* | 60 | Category 2 | Renovation 1 |
| Scenario 5 | HPs, electric boiler, Thermal storage | Wind power | 589.0 | LTDH | 60 | Category 2 | Renovation 2 |

* HTDH (high-temperature district heating), supply temperature: up to 120 °C in winter

* LTDH (low-temperature district heating), supply temperature: 40/60 °C (Future Low-Temperature District Heating Design Guidebook, n.d.).

Table 4

Characteristics of HPs used in this study (Friothersm A.G. Fortum, 2015; Technology Data, 2016b; Sanner, 2012).

| Unit | Design COP | Maximum output (MW) | Heat source | Heat source inlet/outlet temperatures (°C) | DH return/supply (°C) |
|--------------------------------|------------|---------------------|--------------------------|--|------------------------------|
| Air source heat pump (ASHP) | 3.5 | 40 | Ambient air | Hourly outdoor temperature | 35/70 |
| Wastewater heat pump (WWHP) | 3.9 | 40 | Waste heat | 14 (10)/7(3) ^a | 50 (65)/65 (60) ^a |
| Ground source heat pump (GSHP) | 4 | 40 | Geothermal well (~200 m) | 9/4 | 40/80 |

^aHigher values are sewage water temperatures during summer (April to September), while lower values (numbers in parentheses) refer to wintertime (October to March).

Table 5

Electricity distribution fees and taxes used in this study (Kuopio Energy, 2021).

| Electricity Distribution fees and taxes | Value | |
|---|---|------------------|
| Distribution fee | Basic fee | 183.00 €/month |
| | Power charge | 3.10 €/kW, month |
| | Transmission charge, daytime (7 am–10 pm) | 1.40 cents/kWh |
| | Transmission charge, nighttime (10 pm–7 am) | 1.01 cents/kWh |
| Electricity tax, category 1 | 2.79 cents/kWh | |
| Electricity tax, category 2 | 0.87 cents/kWh | |

revenue gained from electricity/heat sales, respectively. Electricity is sold in the day-ahead market (Elsport), which is the main wholesale market in the Nordic power market, Nordpool (Nordpool, 2021). In this study, the revenue of heat sales is the price of heat, which would make the Net Present Value (NPV) of the entire network zero (Patronen et al., 2017). Variable and fixed operational costs are denoted by $P_{O\&M_{var}}$ and $P_{O\&M_{fixed}}$, respectively. Fuel-related costs are calculated by multiplying the fuel price (P_F), fuel tax (T_F), and emission prices (P_{CO_2}) by total fuel consumption (C_F). i indicates the inflation coefficient, which was assumed as 1.

$$EBIT = \left[E_{\frac{E}{H}} \left(P_{\frac{E}{H}} - P_{O\&M_{var}} \right) - C_F (P_F + T_F + P_{CO_2}) - P_{O\&M_{fixed}} \right] i - D \quad (2)$$

Free cash flow (FCF) is calculated from EBIT by the following equation. T_c represents the corporate tax rate. As tax is paid only from net income after deducting all expenses, including personnel and rents, it is not included in the NPV calculation.

$$FCF = EBIT (1 - T_c) - i + D \quad (3)$$

NPV can be calculated from Eq. (4), where FCF_0 represents the initial investment and r is the discount rate of 5%.

$$NPV = -FCF_0 + \sum_{i=1}^n \frac{FCF_i}{(1+r)^i} \quad (4)$$

Assuming an initial guess for heat price in Eq. (2), the NPV can be obtained from Eq. (4). The break-even price for heat can then be obtained by iterating the guess until it makes NPV zero.

2.4. Analyzed business models for the wind power producer

Wind power could be immediately sold to the electricity market when electricity prices are high. The other alternative is when the market price is low: HPs owned by the DH operator could directly use wind production to create hot water for the DH network. Alternatively, when financially attractive, the second possible case is when the DH demand is high and the last needed heat production is usually expensive. This occurs during the coldest periods of winter, generally during weekdays when electricity market prices are high. To evaluate the profitability of bilateral contracts for the wind producer, revenues are calculated in two cases. First, when the wind producer bids all its production on the day-ahead market. The second case is when bilateral contract is available (Scenario 3), in which a segment of the wind production

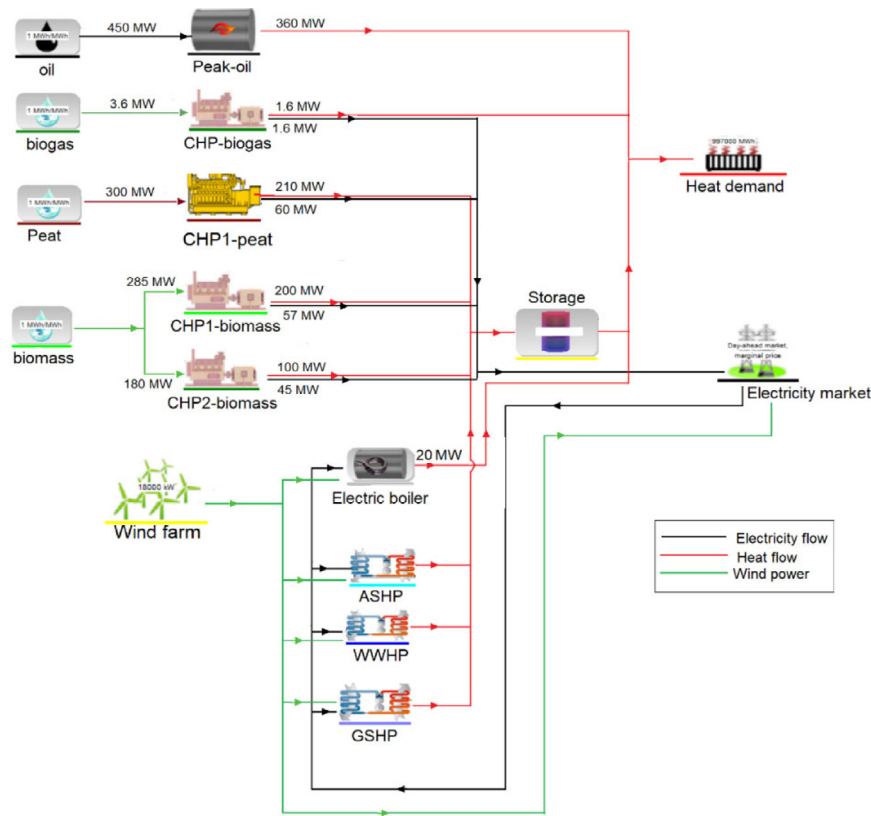

Fig. 1. Schematic of the proposed DH network.

Table 6
Investment parameters of units^a (Kontu et al., 2019; Technology Data, 2016b).

| Unit | Nominal investment | Variable O&M €/MWh | Fixed O&M €/MW/a |
|-----------------|----------------------------|--------------------|------------------|
| CHP | 1.55 M€/MW _{DH} | 4.16 | 23,520 |
| ASHP | 0.86 M€/MW | 2.20 | 2,000 |
| WWHP | 0.67 M€/MW | 2.20 | 2,000 |
| GSHP | 0.90 M€/MW | 2.20 | 5,400 |
| Electric boiler | 0.07 M€/MW | 0.8 | 1,100 |
| Thermal storage | 3.00 M€/GWh _{cap} | 0 | 8.60 |

^aMonetary values in this table correspond to the year 2019.

is sold to the DH network at a fixed price to satisfy the electricity consumption of HPs and the electric boiler. The rest of the production is offered to the day-ahead electricity market. Bilateral contract is meant to secure the wind park owner's profit with a long-term customer and maximize the possibility of utilizing P2H units in the DH network.

In this study, the settled price of electricity in a bilateral contract is the minimum price that makes the NPV of the wind park zero if the entire wind production is sold to the market over the assumed lifetime of wind turbines. The minimum bilateral price is therefore calculated as 30 €/MWh. As the profitability of a bilateral contract depends on day-ahead market prices (which fluctuate a lot each year), to obtain a more holistic view of the effects of this contract on the wind producer's long-term profit, annual revenue is calculated from 2010 to 2020. In this regard, the DH network is also simulated with historical input data (fuel costs, weather conditions, wind speed, and electricity prices) and calibrated against real fuel consumption obtained from Kuopio Energy (2021).

3. Results and discussion

In this section, first, the validation of the studied case study is presented. The simulation results for the different scenarios and the sensitivity analyses on thermal storage volume and EUA prices are placed in Sections 3.2 and 3.4. Section 3.5 examines the impact of wind power supply on the DH network from both parties, i.e., the wind producer and the DH operator.

3.1. The validation of the case study

Simulation models are validated against real production data of the case study DH network (Kuopio Energy, 2019). Fig. 2 illustrates the real fuel consumption in the examined DH network against the simulated reference case in this study. The slightly higher results in the simulation are justified by the minor difference between the calculated and hourly distribution of heating demand, which is confidential.

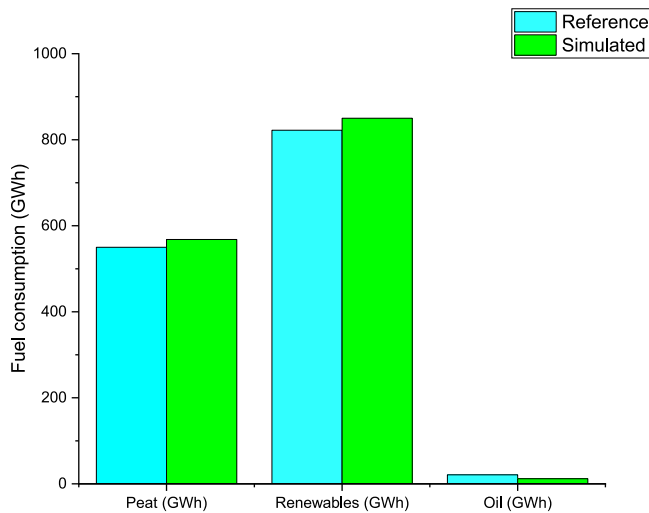

Fig. 2. Comparison between the real fuel consumption of the case study DH network and the simulation results.

3.2. Simulation results

To make the economic results of different years comparable, all monetary values are transferred to the reference year, 2019. Fig. 3 demonstrates fuel and electricity consumption in each scenario and CO₂ emissions on the left and right axes, respectively. Unit-specified heat and power production and the calculated heat production costs for each scenario are shown in Fig. 4. More detailed numerical results of all simulations are listed in Appendix C. Besides simulated scenarios, the reference situation in 2010 (the most recent coldest year) is also depicted to show the changes in the studied DH network that occurred in 2010 and 2019.

A comparison between reference scenarios in 2010 and 2019 in Fig. 3 reveals that the local DH network operator partly substituted peat (the primary fuel in 2010) with biomass in 2019. Although biomass is a carbon-neutral fuel, increasing biomass should not be considered a sustainable solution in the long run because of the adverse impacts of growing biomass consumption on the forest-based carbon sink in the past decade in Finland. Hence, the focus of this study was on promoting the electrification of the DH network.

P2H units in Scenario 1 produced 42% of the total heat demand, resulting in substantial 71% and 94% reductions in peat and oil consumption compared to the reference case in 2019. Biomass was also consumed 16% less in this scenario. Although CO₂ emissions were reduced by 72% in this scenario, the investment costs of the deployed technologies and a lower income gained from CHPs electricity sales (24% lower compared to the reference case) due to their lower running hours resulted in a 23% increase in heat production costs, rising from 28.8 €/MWh in the reference case to 35.7 €/MWh in Scenario 1. In Scenario 2, with storage integration in the network, CHP units production marginally decreased (from 575 GWh in Scenario 1 to 520 GWh in Scenario 2), as depicted in Fig. 4. However, compared to Scenario 1, 5% more revenue is gained from electricity sales of CHP units in Scenario 2 as they can operate during hours with higher electricity prices since some of the heat energy can be stored. Therefore, Scenario 2 resulted in more affordable heat prices (33.8 €/MWh compared to 35.7 €/MWh in Scenario 1) with 11% lower emissions than the previous scenario.

Marginally higher utilization rates of P2H units (3% more heat production) in Scenario 3 compared to Scenario 2 was achieved. The reason for this increase is that P2H units gained more priority

over CHP units as cheaper wind power was provided in Scenario 3 (with a fixed price of 30 €/MWh during the studied year) than the grid power with fluctuating and higher prices, especially during the cold seasons in Scenario 2. Providing wind power in Scenario 3 also resulted in a decrease in peat consumption and CO₂ emissions by 21.4% and 17%, respectively, compared to Scenario 2. Heat prices also decreased by 4.2% than the previous scenario due to lower variable O&M costs in Scenario 3 than Scenario 2, resulting from a 5% lower total fuel consumption. Overall, in comparison with the reference case, all of the proposed technologies (HPs and electric boilers), the thermal storage, and wind power integration into the DH network in Scenario 3 resulted in a total of 81% and 26% reduction in peat and biomass consumption, respectively, and total elimination of oil. CO₂ emissions diminished by nearly 79% compared to the reference case. However, heat production is still 12.5% more expensive than the reference case (32.4 €/MWh in Scenario 3) because of lower income from electricity sales of CHP units (21.8% lower than the reference case). Considering the size of the studied DH network (heat demand of 997 GWh in 2019), abandoning peat without further biomass consumption to fulfill the mentioned climate goals for 2030 and 2035 seems challenging. Thus, extra measures were considered in scenarios 4 and 5. Increased EUA prices and reduced heat demand due to building-level renovations paved the way for abandoning peat in scenarios 4 and 5, making the studied DH carbon neutral.

Lowering electricity tax increases the priority of P2H units in the optimal operation of the DH network. In Scenario 4 with lower tax (Sc4 low tax), P2H units produced 66% of total heat demand, with a 7% increase compared to the same scenario with a higher electricity tax (Sc4 high tax). Although lowering tax resulted in a 12% reduction in the electricity sales compared to the high tax scenario, heat prices witnessed a 5% decrease in the low tax scenario (24.7 €/MWh in the low tax scenario compared to the 26.0 €/MWh in the high tax scenario) due to reduced variable O&M costs of P2H units, as can be seen in Fig. 4. Even though the share of biomass consumption in Scenario 5 has decreased substantially (66% reduction in comparison with the reference case), as can be seen in Fig. 3, this scenario did not yield satisfying results in terms of heat cost because of the lower heat production by CHP units and consequently lower electricity sales to the electricity market. Also, Scenario 5 requires a substantial investment in buildings' insulation, which may be challenging to realize throughout the building stock. Hence, Scenario 4, with a lower electricity tax, is the most optimal scenario in which 66% and 34% of heat demand is satisfied with P2H and CHP units, respectively, with zero emissions. Also, biomass consumption was reduced significantly, by 51%, compared to the reference case. Regarding heat prices, heat can be produced 14.4% more affordably in this scenario (26.0 €/MWh) than in the reference case (28.8 €/MWh).

3.3. Sensitivity analysis on thermal storage volume

Fig. 5 demonstrates how thermal storage capacity affects break-even prices for heat production in scenarios 2–5.

Due to the investment cost of storage, its adoption into the DH network is followed by a slight increase in the break-even prices for heat in all scenarios, peaking at the storage volume of 5000 m³. However, a larger storage tank results in a fall in the break-even price of heat production. The downward trend flattens out, reaching the size of 20,000 m³, where further enlarging the storage does not bring additional benefits. Thus, the optimum size of the storage is in the range of 15,000–20,000 m³, corresponding to 800–1,000 MWh capacity. Despite the calculated size in terms of the minimum break-even cost of heat, the required size of

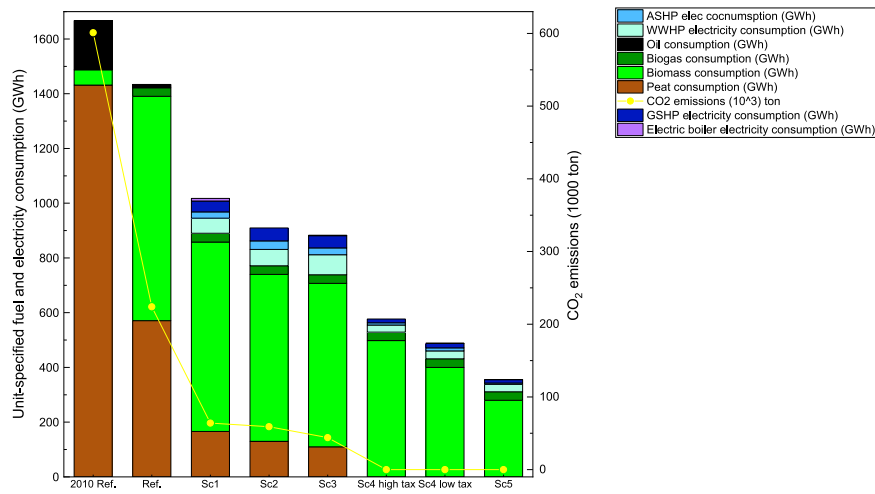

Fig. 3. Unit-specified fuel and electricity consumption versus CO₂ emissions in 2010 and in the scenarios studied.

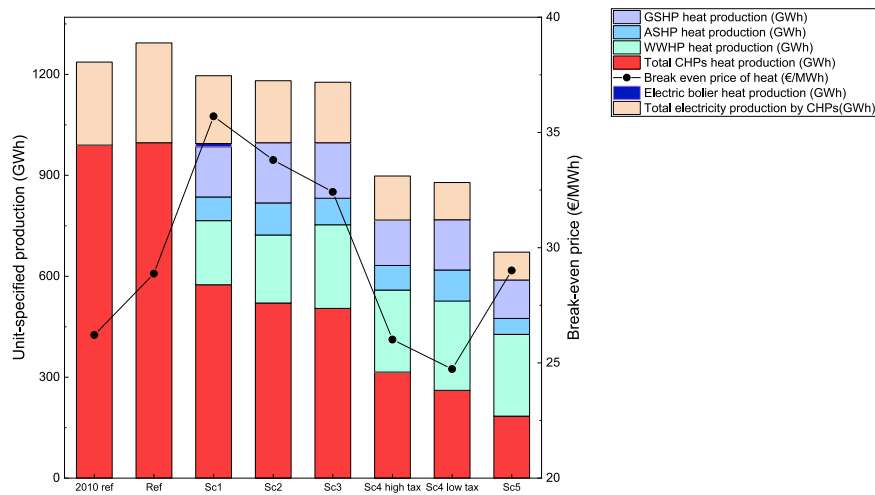

Fig. 4. Unit-specified heat and power production versus break-even price for heat in 2010 and in the scenarios studied.

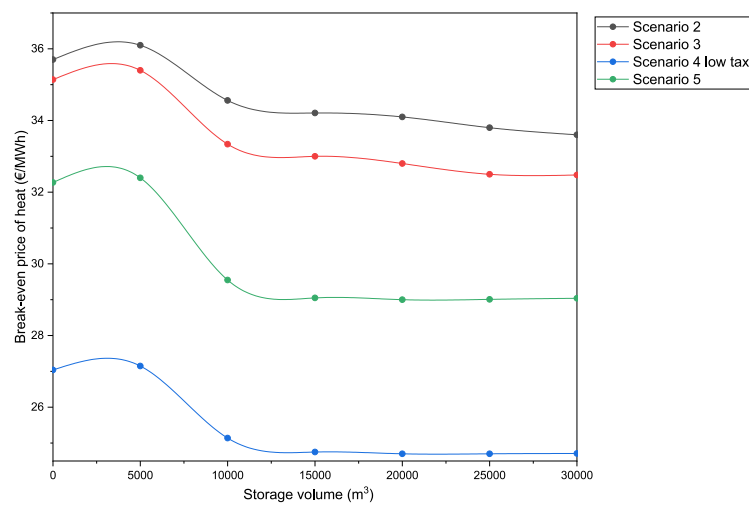

Fig. 5. Effect of thermal storage volume on the break-even prices for heat in Scenarios 2–5.

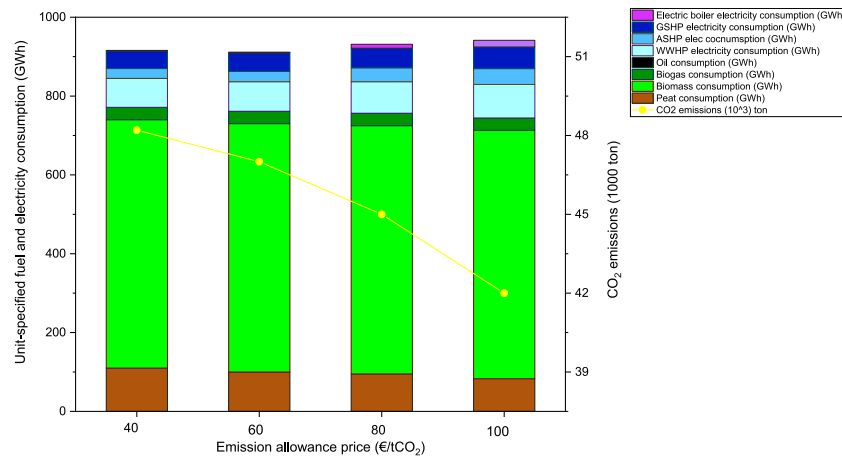

Fig. 6. Effect of EUA prices on the optimal operation of the DH network in Scenario 3.

storage to cover hourly heat demand in the simulations also in winter was 25,000 m³, and thus it was used in the scenarios.

3.4. Sensitivity analysis on EUA prices

In this section, Scenario 3 is simulated with different EUA prices to evaluate the effects of increasing prices on the optimal operation of the DH network. Increasing the EUA price from the reference of 40 €/tCO₂ in 2019 to 100 €/tCO₂ makes the carbon cost of peat rise from 15.5 €/MWh to 38.7 €/MWh. More expensive peat results in a nearly 12% increase in heat production by P2H units and a 24% decrease in peat consumption. Consequently, emissions diminished by a total of 11%, as can be seen in the figure. On the other hand, heat prices increased from 32.4 €/MWh in Scenario 3 with the reference EUA price (40 €/tCO₂) to 35.0 €/MWh with the EUA price of 100 €/tCO₂. This increase is justified by a higher variable O&M cost resulting from more expensive fuel and consequently lower electricity sales of CHP units as they were less in operation (nearly 8% less heat production of CHP units with the EUA price of 100 €/tCO₂ than the reference amount in Scenario 3).

Notably, increasing EUA prices does not affect the amount of biomass consumption. This is because of the relatively lower biomass price (18.2 €/MWh according to Table 1) due to the abundance of this resource in Finland. Thus, there are not enough hours that P2H technologies would be more profitable to run than biomass-CHP in the optimal operation (Fig. 6).

3.5. Bilateral contract with DH operator and wind farm

The benefits of providing wind power in promoting the electrification of the DH network were explained earlier. This section scrutinizes the effects of bilateral contract on wind producer's revenue. Thus, revenue is calculated and compared in two cases: (1) when all of the products are sold in the day-ahead market and (2) when wind power is provided for the P2H units in the DH side with a fixed price under a bilateral agreement between two parties in Scenario 3. The results are illustrated in Fig. 7. Furthermore, to gain a more holistic view of the effects of bilateral contract and fluctuating day-ahead electricity prices on the wind farm owner's revenue in the long run, the results were calculated over 11 years, from 2010 to 2020. Fig. 8 compares the utilization rates of P2H units in the DH side in scenarios 2 and 3 when they consume either grid power with hourly market prices or wind power, respectively.

As shown in Fig. 7 market electricity prices directly affect the revenue of wind power sales. In years with higher electricity prices (such as 2010, 2011, 2018, and 2019), it is more beneficial for the wind producer to sell the product to the electricity market because bilateral contract brings considerably less benefit than the spot market. Because of higher electricity prices in those years, CHP units had more priority over P2H units. This justifies the reason for the relatively lower utilization rates of P2H units in the mentioned years in Scenario 2, as illustrated in Fig. 8. For the DH side, in the mentioned years with higher electricity prices (2010, 2011, 2018, and 2019) bilateral contract increases the utilization rates of P2H units in the DH network, as can be seen from Fig. 8.

In addition to electricity prices, other factors like fuel prices, taxes, and EUA prices also influence the operation of P2H units. For example, in 2019, despite the high electricity prices, P2H units were more in operation compared to 2018 with lower average electricity prices. The reason for this is a sharp increase in the EUA prices from 2018 to 2019 (Carbon Price Viewer - Ember, 2021), resulting in more expensive fossil fuels, which ultimately favors the utilization of P2H units over the conventional CHP units in a DH network.

The higher operating hours of P2H units from 2012 to 2017, and 2020 in Fig. 8 stem from the cheaper prices of electricity in the corresponding years. Nevertheless, bilateral contract further promoted electrification (higher utilization rates of P2H units) in some of the mentioned years (2012, 2013, 2014, 2016, and 2017) despite the relatively cheaper electricity spot prices.

To sum up, bilateral contract facilitates electrification and thus decarbonization of the DH network in most of the studied years, as can be concluded from Fig. 8, which shows that all units were more in operation in Scenario 3 compared to Scenario 2.

For the wind producer, the average revenues shown over the entire period in Fig. 7 reveal no additional benefit gained from the bilateral contract. However, the advantages of a long-term contract for the wind farm owner are twofold. First, despite the enormous fluctuations of electricity prices in different years caused, e.g., by the intermittent production of renewable sources, owners can secure their revenue without a considerable profit loss. This is important for long-term investment planning. Secondly, with the foreseen decrease in electricity prices due to the increasing adoption of renewables and nuclear power in Finland by 2030 (Khosravi et al., 2020), more revenue may be gained from bilateral contract than selling the wind product in the competitive market. Notably, there is much uncertainty about future

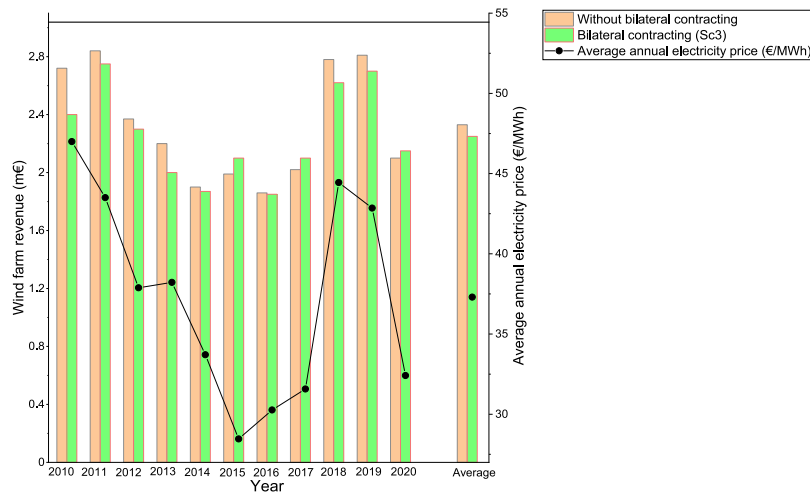

Fig. 7. Wind farm revenue versus annual average electricity prices (2019, EUA=40 e/tCO₂).

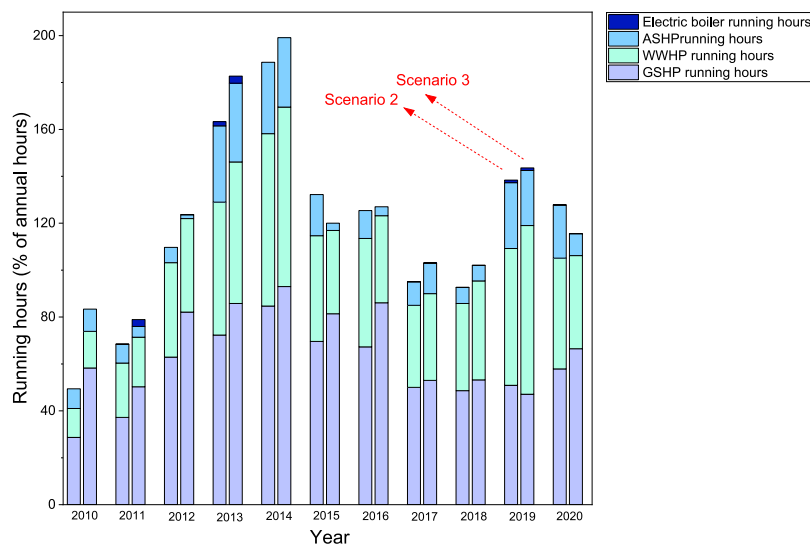

Fig. 8. P2H units running hours in Scenario 2 (consuming power from the grid) and Scenario 3 (with wind power) from 2010 to 2020.

electricity spot prices in the Nordic power market. Thus, studying the sensitivity of hourly spot prices on the mutual profitability of bilateral contracts is recommended for later analyses.

4. Conclusions

This study examined the rapid decarbonization of a middle-sized city district heating (DH) network by integrating power-to-heat (P2H) units including an air source heat pump (ASHP), a ground source heat pump (GSHP), a wastewater heat pump (WWHP), an electric boiler and wind power and heat storage together with ambitious building energy renovations. The study also investigated the effects of the electricity tax and European CO₂ emission allowance (EUA) prices on the optimal DH operation (minimizing net production cost) and break-even prices of heat production.

The role of the wind farm in supplying carbon-neutral electricity for HPs and the electric boiler with a fixed price was investigated in the context of a mutually beneficial bilateral contract between two stakeholders, i.e., the DH operator and the

wind producer. To gain a more holistic view of the benefits of the bilateral contract for both parties in the long run, wind producers' revenues were calculated and compared for 11 years (2010–2020). The main conclusions of this research are outlined as follows:

- P2H units were unable to satisfy the peak heat demands in the coldest periods without a reduction in city heat demand. However, adding thermal storage in Scenario 2 contributed to a 71% reduction in peat consumption in 2019 compared to the reference case while meeting the entire heat demand.
- Abandoning peat is possible with a higher carbon cost, decreased electricity tax, a low-temperature district heating network, and energy renovation of buildings. Scenarios 4 and 5 managed to eliminate peat and significantly reduce the consumption of biomass as well. These scenarios are simulated with necessary simplifying assumptions, and especially in Scenario 5, the expensive required building renovation investments may not be plausible in the imminent future. In that sense, Scenario 4, with a moderate renovation

may be more feasible and with more affordable heat prices than the reference case. The decreasing heat sales and CHP electricity sales also pose a challenge for the DH operators' business, especially in Scenario 5.

- These results indicate that promoting further energy renovation measures in existing building stock is vital to achieve low-carbon heating in Finnish DH systems, while keeping heating costs affordable.
- Providing wind power with a fixed annual price could promote the electrification of the DH network. Operation rates of P2H units increased in Scenario 3, where wind power was provided for the units, resulting in a decrease in heat prices, total fuel consumption, and consequently, CO₂ emissions. Peat is reduced substantially in this scenario, covering only 14% of the total fuel share necessary for peak heat demand times.
- Bilateral contract for the wind producer is secured revenue without getting affected by the variable and possibly decreasing electricity prices caused by the penetration of renewables. The producer can gain almost the same revenue as when wind production is sold in the day-ahead electricity market in the studied eleven-year period.
- Results from sensitivity analysis indicate that the optimal range of storage size for a medium-sized DH network is reached at 15,000–20,000 m³. However, to cover the hourly heat demand with these technologies in winter, the required volume of storage is at least 25,000 m³.

CRedit authorship contribution statement

Nima Javanshir: Conceptualization, Methodology, Data curation, Software, Investigation, Writing – original draft, Validation, Visualization. **Sanna Syri:** Conceptualization, Methodology, Supervision, Visualization, Writing – review & editing, Project administration, Funding acquisition. **Antti Teräsvirta:** Data curation, Modeling the reference case. **Ville Olkkonen:** Conceptualization, Writing – review & editing.

Declaration of competing interest

The authors declare that they have no known competing financial interests or personal relationships that could have appeared to influence the work reported in this paper.

Acknowledgments

The Academy of Finland, through Grant 326346 for profiling funding 5 for Energy Storage, is acknowledged for funding this study. We gratefully acknowledge the building energy renovation data provided by Dr. Tech. Janne Hirvonen from the RenewFIN project of the Academy of Finland.

Appendix A. Heat pump simulation

The given coefficients of performance (COP) in Table 4 are design COPs. In practice, DH water supply temperature varies with outdoor temperature, as indicated by the control curve illustrated in Fig. A.1. Hence, in this study, hourly variation of supply temperatures for HPs is used. Based on the given inputs, i.e., the design COP and heat source/sink inlet/outlet temperatures, the actual COP (COP with varying DH water temperature) is calculated at each time step. The assumption is that HPs can provide the required supply temperatures for the DH network (Bamigbetan et al., 2017; Oilon, 2020). However, in peak times

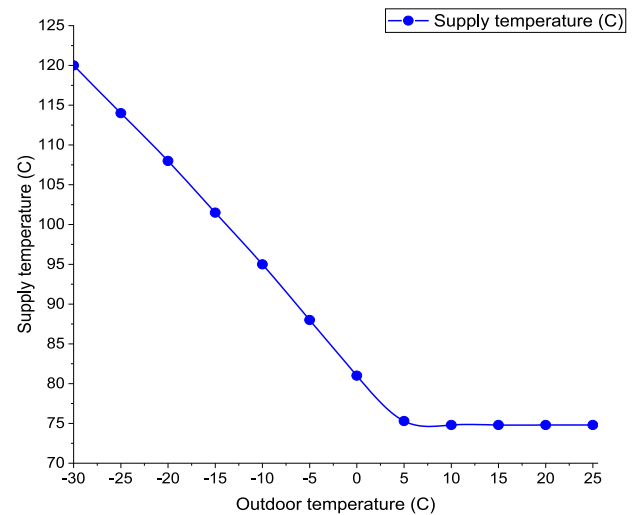

Fig. A.1. The control curve of the DH water supply temperature.

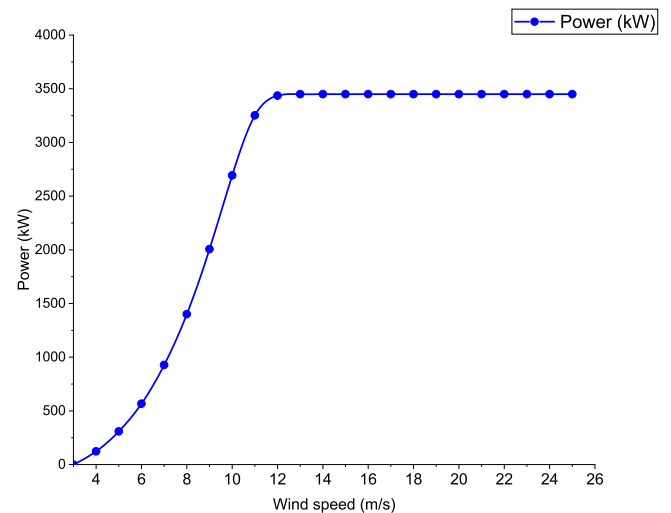

Fig. B.1. The power curve of the wind turbine used in the simulation (Wind turbine models, 2021).

in winter, HPs should co-produce with other units to increase the supply temperature enough for all types of housing stock in the region with different insulations. Fig. A.1 depicts the relation between DH water supply temperature and outdoor temperature.

Appendix B. Wind turbine characteristics and connection to the grid

Regarding the wind park connection to the transmission network, the simulated park is just on the borderline between 20 kV (distribution medium voltage) and 110 kV (sub-transmission). As this is a hypothetical wind park in the region, it is assumed that there is a 110 kV/20 kV substation near the park, less than 500 meters away. Thus, a connection at 20 kV is possible, using a specially ordered large conductor or copper conductors in the cable system (Fingrid, 2021b,a). Therefore, the wind park developer would not have to pay for a dedicated substation. Thus, only the initial investment and fixed costs related to the turbine and land purchase and connection to the network are considered in the investment analysis of wind farms.

Table B.1

Characteristics of the simulated wind turbines (Technology Data, 2016b; Wind turbine models, 2021).

| Model | Rated power (MW) | Cut-in wind speed (m/s) | Rated wind speed (m/s) | Cut-out wind speed (m/s) | Hub height (m) | Rotor diameter (m) | Investment cost (m€/MW) | Fixed cost (€/MW/a) | Lifetime (years) |
|-------------|------------------|-------------------------|------------------------|--------------------------|----------------|--------------------|-------------------------|---------------------|------------------|
| Vestas V112 | 3.45 | 3.0 | 13.0 | 25.0 | 84 | 112.0 | 0.8 | 14000 | 20 |

Table C.1

Numerical results of the scenarios.

| | Ref. | Sc1 | Sc2 | Sc3 | Sc4 high tax | Sc4 low tax | Sc5 |
|---|--------|--------|--------|--------|--------------|-------------|------|
| Produced heat (GWh) | 997 | 995 | 997 | 997 | 768 | 768 | 589 |
| Total heat production by CHPs (GWh) | 997 | 575 | 520 | 504 | 315 | 261 | 184 |
| Total heat production by P2H units (GWh) | 0 | 420 | 477 | 493 | 453 | 507 | 405 |
| Total electricity sales by CHPs (1000 €) | 14,068 | 10,782 | 11,267 | 11,001 | 9599 | 8449 | 6824 |
| Electricity consumption of ASHP (GWh) | 0.0 | 23.1 | 31.0 | 24.8 | 8.5 | 11.4 | 4.7 |
| Electricity consumption of WWHP (GWh) | 0.0 | 55.0 | 59.8 | 73.3 | 26.1 | 28.8 | 26.8 |
| Electricity consumption of GSHP (GWh) | 0.0 | 39.5 | 47.1 | 44.5 | 14.0 | 16.2 | 12.5 |
| Electricity consumption of electric boiler (GWh) | 0.0 | 9.7 | 0.0 | 1.5 | 0.0 | 0.3 | 0.2 |
| WWHP operation hours (% of annual hours) | 0.0 | 56.5 | 58.3 | 71.9 | 70.0 | 76.1 | 69.9 |
| ASHP operation hours (% of annual hours) | 0.0 | 31.5 | 28.1 | 23.5 | 22.1 | 27.8 | 14.4 |
| GSHP operation hours (% of annual hours) | 0.0 | 51.8 | 50.9 | 47.1 | 39.4 | 42.9 | 33.0 |
| Electric boiler operation hours (% of annual hours) | 0.0 | 8.7 | 1.1 | 1.1 | 0.0 | 0.2 | 0.2 |
| Oil consumption (GWh) | 12 | 1 | 0 | 0 | 0 | 0 | 0 |
| Peat consumption (GWh) | 570 | 166 | 140 | 110 | 0 | 0 | 0 |
| Biomass consumption (GWh) | 820 | 692 | 620 | 610 | 498 | 400 | 280 |
| Biogas consumption (GWh) | 31 | 31 | 31 | 32 | 31 | 31 | 31 |
| CO ₂ emissions (kt CO ₂) | 224.3 | 64.5 | 58.1 | 48.2 | 0.0 | 0.0 | 0.0 |
| Total variable O&M cost (1000€) | 35,525 | 32,152 | 30,830 | 29,641 | 15,168 | 13,029 | 9503 |
| Break-even price for heat (€/MWh) | 28.8 | 35.7 | 33.8 | 32.4 | 26.0 | 24.7 | 29.0 |

Considering the reactive power charge, modern wind turbines would normally not have to pay reactive power tariffs because turbines have enough power to go through a converter to provide the power factor required. However, they may have to de-rate their peak output of 10% or 0.5 MW per turbine to provide mandatory reactive power support. Thus, in this paper, a reactive power charge is not directly considered in electricity distribution costs. Instead, the peak output of turbines has been de-rated to 90% to give the headroom to provide reactive power support (Fingrid, 2020). This calculation assumes the generator can do what is required concerning reactive power.

The properties of the simulated turbines and investment data are summarized in Table B.1 (Technology Data, 2016b; Wind turbine models, 2021). Fig. B.1 depicts the power curve of the turbine (Wind turbine models, 2021).

Appendix C. Simulation results

See Table C.1.

References

2019. Ministry of economic affairs and employment. <https://julkaisut.valtioneuvosto.fi/handle/10024/161977>.
- Abdurafikov, R., Grahn, E., Kannari, L., Ypyä, J., Kaukonen, S., Heimonen, I., Paiho, S., 2017. An analysis of heating energy scenarios of a Finnish case district. *Sustainable Cities Soc.* 32, 56–66. <http://dx.doi.org/10.1016/j.scs.2017.03.015>.
- Bamigbetan, O., Eikevik, T.M., Neksä, P., Bantle, M., 2017. Review of vapour compression heat pumps for high temperature heating using natural working fluids. *Int. J. Refrig.* <http://dx.doi.org/10.1016/j.ijrefrig.2017.04.021>.
- Böttger, D., Götz, M., Theofilidi, M., Bruckner, T., 2015. Control power provision with power-to-heat plants in systems with high shares of renewable energy sources – An illustrative analysis for Germany based on the use of electric boilers in district heating grids. *Energy* 82, 157–167. <http://dx.doi.org/10.1016/j.ENERGY.2015.01.022>.
- Brealey, R., Myers, S., Allen, F., 2008. *Principles of Corporate Finance*, tenth ed. McGraw-Hill/Irwin, New York.
- Building stock in Kuopio - Opasnet [WWW Document], 2021. http://en.opasnet.org/w/Building_stock_in_Kuopio (Accessed 9 March 2021).
- Carbon Price Viewer - Ember [WWW Document], 2021. URL <https://ember-climate.org/data/carbon-price-viewer/> (Accessed 13 June 2021).
- District Heating Statistics, Finnish Energy [WWW Document], 2021. https://energia.fi/en/newsroom/publications/energy_year_2020_-_district_heating.html#material-view (Accessed 21 June 21).
- EnergyPRO [WWW Document], 2020. <https://www.emd.dk/energypro/>. (Accessed 23 June 2020).
- Fingrid- [WWW Document], 2021a. Grid code specifications for power generating facilities. <https://www.fingrid.fi/en/grid/grid-connection-agreement-phases/specifications-for-the-operational-performance-of-power-generating-facilities/> (Accessed 12 April 2021).
- Fingrid [WWW Document], 2020. Reactive power requirements for power park modules and switched reactive power compensation. <https://www.fingrid.fi/globalassets/dokumentit/en/customers/grid-connection/reactive-power-requirement-of-power-plants-and-switched-reactive-power-compensation.pdf> (Accessed 12 April 2021).
- Fingrid [WWW Document], 2021b. Real-time CO₂ emissions estimate. <https://www.fingrid.fi/en/electricity-market/electricity-market-information/real-time-co2-emissions-estimate/> (Accessed 12 April 2021).
- Finland's environmental administration [WWW Document], 2016. [https://www.ymparisto.fi/en-US/Maps_and_statistics/The_state_of_the_environment_indicators/Climate_change_and_energy/Energy_consumption_no_longer_increasing\(28723\)](https://www.ymparisto.fi/en-US/Maps_and_statistics/The_state_of_the_environment_indicators/Climate_change_and_energy/Energy_consumption_no_longer_increasing(28723)). (Accessed 28 June 2021).
- Finlex [WWW Document], 2019. Act on the prohibition of the energy use of coal 416/2019. <https://www.finlex.fi/fi/laki/alkup/2019/20190416> (Accessed 25 January 2022).
- Finnish Competition and Consumer Authority [WWW Document], 2021. <https://www.kkv.fi/en/>. (Accessed 28 June 2021).
- Finnish Energy [WWW Document], 2020. District heating statistics. https://energia.fi/en/newsroom/publications/district_heating_statistics.html#material-view. (Accessed 12 April 2021).
- Finnish Meteorological Institute [WWW Document], 2021. Weather data. <https://en.ilmatietaenlaitos.fi/>. (Accessed 12 April 2021).
- Finnish Wind Power Association [WWW Document], 2021. About wind power in Finland. <https://tuulivoimayhdistys.fi/en/wind-power-in-finland-2/wind-power-in-finland/about-wind-power-in-finland> (Accessed 17 June 2021).
- Fortum, Suomenoja power plant [WWW Document], <https://www.fortum.com/media/2019/05/new-heat-pump-unit-fortum-suomenoja-share-carbon-neutral-district-heating-production-will-increase-over-50-cent-2022>. (Accessed 7 June 2021).
- Friotherm A.G. Fortum [WWW Document], 2015. Two unitop 50 FY heat pumps. 2015. URL https://www.friotherm.com/wp-content/uploads/2017/11/E10-15_Suomenoja.pdf. (Accessed 11 June 2021).
- Heat Roadmap Europe [WWW Document], 2019. URL <https://heatroadmap.eu/>. (Accessed 19 April 2021).
- Hirvonen, J., Heljo, J., Jokisalo, J., Kurvinen, A., Saari, A., Niemelä, T., Sankelo, P., Kosonen, R., 2021. Emissions and power demand in optimal energy retrofit scenarios of the Finnish building stock by 2050. *Sustainable Cities Soc.* 70, 102896. <http://dx.doi.org/10.1016/j.scs.2021.102896>.

- Hirvonen, J., Jokisalo, J., Heljo, J., Kosonen, R., 2018. Towards the EU emissions targets of 2050: optimal energy renovation measures of Finnish apartment buildings. *Energy* 181, 649–672. [10.1016/j.energy.2018.10.111](https://doi.org/10.1016/j.energy.2018.10.111).
- Javanshir, Nima, Mahmoudi, S., Mohammad, S., Akbari Kordlar, Mehri, Rosen Marc, A., 2019. Thermodynamic and exergoeconomic analyses of a novel combined cycle comprised of vapor-compression refrigeration and organic rankine cycles. *Sustain.* <https://doi.org/10.3390/su11123374>.
- Johannsen, R.M., Arberg, E., Sorknæs, P., 2021. Incentivising flexible power-to-heat operation in district heating by redesigning electricity grid tariffs. *Smart Energy* 2, 100013. <https://doi.org/10.1016/j.segy.2021.100013>.
- Kazagic, A., Merzic, A., Redzic, E., Tresnjo, D., 2019. Optimization of modular district heating solution based on CHP and RES - demonstration case of the municipality of Visoko. *Energy* 181, 56–65. <https://doi.org/10.1016/j.energy.2019.05.132>.
- Khosravi, A., Olkkonen, V., Farsaei, A., Syri, S., 2020. Replacing hard coal with wind and nuclear power in Finland- impacts on electricity and district heating markets. *Energy* 203, <https://doi.org/10.1016/j.energy.2020.117884>.
- Kontu, Rinne, S., Junnila, S., 2019. Introducing modern heat pumps to existing district heating systems – Global lessons from viable decarbonizing of district heating in Finland. *Energy* 166, 862–870. <https://doi.org/10.1016/j.energy.2018.10.077>.
- Kuopio Energy [WWW Document], 2019. Annual reports. <https://www.kuopionenergia.fi/media-ja-materiaalit/raportit/> (Accessed 12 April 2021).
- Kuopio Energy [WWW Document], 2021. URL <https://www.kuopionenergia.fi/en/> (Accessed June 23 2021).
- Kuopio Gate, Adven [WWW Document], 2021. URL <https://adven.com/fi/referenssit/taysin-hiilineutraali-kuopion-portti/>. (Accessed 7 June 2021).
- Kuopio Energia- Annual report, 2010. https://kuopionenergia.fi/wp-content/uploads/2016/02/KE_vuosikertomus_2010_LR.pdf.
- Li, Haoran, Hou, Juan, Hong, Tianzhen, Ding, Yuemin, Nord, Natasa, 2021. Energy, economic, and environmental analysis of integration of thermal energy storage into district heating systems using waste heat from data centres. *Energy* 219, <https://doi.org/10.1016/j.energy.2020.119582>.
- Nordpool, Day-ahead market [WWW Document], 2021. URL <https://www.nordpoolgroup.com/the-power-market/Day-ahead-market/> (Accessed 4 December 2021).
- Nordpool [WWW Document], 2021. Day-ahead prices. URL <https://www.nordpoolgroup.com/Market-data1/#/nordic/table> (Accessed 12 April 2021).
- Official Journal of European Union [WWW Document], 2003. Directive 2003/87/EC of the European parliament and of the council of 13 2003 establishing a scheme for greenhouse gas emission allowance trading within the community and amending council directive 96/61/EC.
- Official Journal of European Union [WWW Document], 2020. Commission recommendation on energy poverty. URL <https://eur-lex.europa.eu/legal-content/EN/TXT/?uri=CELEX:32020H1563> (Accessed 20 April 2021).
- Oilon [WWW Document], 2020. URL <https://oilon.com/en-gb/new-oilon-chc-technology-for-kuopion-energia-in-finland/>. (Accessed 7 June 21).
- Østergaard, P.A., Andersen, A.N., 2021. Variable taxes promoting district heating heat pump flexibility. *Energy* 221, 119839. <https://doi.org/10.1016/j.energy.2021.119839>.
- Paiho, S., Reda, F., 2016. Towards next generation district heating in Finland. *Renew. Sustain. Energy Rev.* <https://doi.org/10.1016/j.rser.2016.07.049>.
- Paiho, S., Saastamoinen, H., Hakkarainen, E., Similä, L., Pasonen, R., Ikäheimo, J., Rämä, M., Tuovinen, M., Horsmanheimo, S., 2018. Increasing flexibility of Finnish energy systems—A review of potential technologies and means. *Sustainable Cities Soc.* <https://doi.org/10.1016/j.scs.2018.09.015>.
- Patronen, J., Kaura, E., Torvestad, C., 2017. Nordic heating and cooling nordic approach to EU's heating and cooling strategy. <https://dx.doi.org/10.6027/TN2017-532>.
- Renewables.ninja [WWW Document], 2021. URL <https://www.renewables.ninja/> (Accessed 12 April 2021).
- Sanner, B., 2012. Geothermal data Finland. <http://www.geoelec.eu/wp-content/uploads/2012/04/GEOELEC-BSA-GT-finland-vilnius.pdf>.
- Siddiqui, S., Macadam, J., Barrett, M., 2021. The operation of district heating with heat pumps and thermal energy storage in a zero-emission scenario. *Energy Rep.* 7, 176–183. <https://doi.org/10.1016/j.egypro.2021.08.157>.
- Siksnelyte-Butkiene, I., Streimikiene, D., Balezentis, T., 2021. Multi-criteria analysis of heating sector sustainability in selected north European countries. *Sustainable Cities Soc.* 69, 102826. <https://doi.org/10.1016/j.scs.2021.102826>.
- Sorknæs, P., 2021. Hybrid energy networks and electrification of district heating under different energy system conditions. *Energy Rep.* 7, 222–236. <https://doi.org/10.1016/j.egypro.2021.08.152>.
- Spirito, G., Dénarié, A., Cirillo, V.F., Casella, F., Famiglietti, J., Motta, M., 2021. Energy mapping and district heating as effective tools to decarbonize a city: Analysis of a case study in northern Italy. *Energy Rep.* 7, 254–262. <https://doi.org/10.1016/j.egypro.2021.08.147>.
- Statistics Finland [WWW Document], 2022a. Energy consumption in households in 2019. URL https://www.stat.fi/til/asen/2019/asen_2019_2020-11-19_kuv_002_en.html. (Accessed 21 January 2022).
- Statistics Finland [WWW Document], 2022b. Fuel classification. URL https://tilastokeskus.fi/tup/khkinv/khkaasut_polttoaineluokit.html (Accessed 21 January 2022).
- Statistics Finland [WWW Document], 2022c. Fuel prices. https://www.stat.fi/til/ehi/2019/04/ehi_2019_04_2020-03-12_tau_001_en.html. (Accessed 21 January 2022).
- Statistics Finland [WWW Document], 2022d. Currency factor. URL https://www.stat.fi/til/khi/2019/khi_2019_2020-01-16_tau_001.pdf (Accessed 21 January 2022).
- Technology Data [WWW Document], 2016b. Danish energy agenc. URL <https://ens.dk/en/our-services/projections-and-models/technology-data> (Accessed 12 April 2021).
- Teräsvirta, A., Syri, S., Hiltunen, P., 2020. Small nuclear reactor-nordic district heating case study. *Energies* 13, <https://doi.org/10.3390/en13153782>.
- Todorov, O., Alanne, K., Virtanen, M., Kosonen, R., 2020. A method and analysis of aquifer thermal energy storage (ATES) system for district heating and cooling: A case study in Finland. *Sustainable Cities Soc.* 53, 101977. <https://doi.org/10.1016/j.scs.2019.101977>.
- Wang, Z., 2018. Heat pumps with district heating for the UK's domestic heating: Individual versus district level. In: *Energy Procedia*. Elsevier Ltd, pp. 354–362. <https://doi.org/10.1016/j.egypro.2018.08.199>.
- Wind turbine models [WWW Document], 2021. Vestas v112-3.45. URL <https://en.wind-turbine-models.com/turbines/1247-vestas-v112-3.45> (Accessed 12 April 2021).
- Zhang, H., Zhou, L., Huang, X., Zhang, X., 2019. Decarbonizing a large City's heating system using heat pumps: A case study of Beijing. *Energy* 186, 115820. <https://doi.org/10.1016/j.energy.2019.07.150>.